



PROTECTIVE INDUSTRIAL PRODUCTS

Leaders in Hand Protection and PPE

SAFETY PRODUCTS CATALOG / USA

PROTECTIVE INDUSTRIAL PRODUCTS, INC.
www.pipusa.com



PROTECTIVE INDUSTRIAL PRODUCTS

WELCOME TO THE NEW PIP® SAFETY PRODUCTS CATALOG

Continuing the tradition of sharing our products and the value they deliver in one convenient reference piece.

Recent global events are requiring many of us to adapt – making a digital, touchless experience the preferred method for literature for the foreseeable future. We also know that tablets and smartphones are now the go-to means for accessing up-to-date information. Still, we recognize that there is value in having - at the very least - an offline copy of the catalog on a job site or factory floor where internet access or device access may be limited.

Our new catalog has been developed with this in mind, by optimizing the layout for both a digital and physical presentation, while still being able to provide an engaging experience with a “flip-through” effect when viewed on a screen.

There are three simple ways to view our new catalog:

1. **Digital Flipbook Link:** Click on this link to view as a digital flipbook then select “add to your home screen” to create a shortcut on your tablet or smartphone for easy future reference. The flipbook version is a live link and will be updated automatically.
2. **Download PDF:** Visit the literature section of www.pipusa.com to download a PDF. Please note that that we will be making regular updates as our product offering continues to evolve.
3. **USB Key:** Call your PIP® Sales Representative or email a request to marketing@pipusa.com.

Our new catalog now features products from the newest members of the PIP Global family including **Boss®**, **Dynamic®**, **Worldwide Protective Products**, **Uniform Technology®**, **QRP®** and **West Chester®**. Other noteworthy features include:

- > **Portrait format** for ease of handling physical copies and enhanced online viewing for tablets and mobile devices
- > **Two-part format:** Safety Products Section and Safety Solutions Section
 - Pages 5 to 230 are product-focused and represent **Safety products** used by most industrial and construction workers
 - Pages 231 to 322 provide full **Safety solutions** for Chemical Protection, Food Safety, Controlled Environment, Welding Safety and Electrical Safety
- > **Product images** within each section are sorted by Type, Application and/or Performance Specification
- > **Product tables** list by style number, allowing for the easy comparison of product attributes, quick selection or cross-referencing
- > Searching is now all digitized on the flipbook version:
 - **Table of Contents** have live links that take you right to the section you’re looking for
 - The **Search Icon** allows you to instantly access any product by item number or keyword
- > **High-Impact Intro Pages** divide sections and provide key facts about products, compliance and industry performance standards

PIP USA ADMINISTRATION & SALES LOCATIONS

- > **PIP USA Global Headquarters & Industrial Safety Division**
968 Albany Shaker Road
Latham, NY 12110
Customer Service Direct: 855-284-6800
Main Phone: 518-861-0133
sales@pipusa.com • www.pipusa.com
- > **West Chester Protective Gear**
Retail Division
11500 Canal Road
Cincinnati, OH 45241
800-647-1900
- > **Worldwide Protective Products**
4255 McKinley Parkway
Hamburg, NY 14075
716-825-0808
1409 Worldwide Lane
Wilkesboro, NC 28697
336-838-1068
- > **Uniform Technology**
1501 S. Sunset Street
Longmont, CO 80501
303-774-7747

DISTRIBUTION CENTERS

- > Olive Branch Sales & Distribution Center
8331 Frontage Road
Olive Branch, MS 38654
816,000 sq. ft
- > New York Distribution Center
Northeastern Industrial Park
2 Van Buren Blvd. • Building 4
Guilderland Center, NY 12085
165,000 sq. ft
- > California Sales & Distribution Center
9100 9th Street • Suite 100
Rancho Cucamonga, CA 91730
60,000 sq. ft

NORTH AMERICAN MANUFACTURING FACILITIES

- > Guilderland Center, NY
- > Chaska, MN
- > Hamburg, NY
- > Wilkesboro, NC
- > North Attleboro, MA
- > Laval, QC
- > Toronto, ON
- > Tijuana, MX

Use the QR code

IN EACH SECTION HEADER
TO VIEW ONLINE AND
DOWNLOAD YOUR **SPEC SHEETS**



Contents

SAFETY PRODUCTS SECTION

HAND & ARM PROTECTION

- [5](#) Cut Resistant Gloves Coated Seamless Knit
- [25](#) Cut Resistant Gloves Uncoated Knit
- [35](#) General Purpose Gloves Coated Seamless Knit
- [45](#) String Knits with Pattern Grip
- [47](#) Uncoated String Knits
- [48](#) Cut-and-Sewn Nitrile Dipped
- [49](#) Cut-and-Sewn Latex Dipped
- [50](#) Canvas Gloves
- [51](#) Fabric Work Gloves
- [52](#) Heat Protection
- [55](#) Cold Protection
- [59](#) Leather
- [65](#) Parade Gloves
- [67](#) High Performance Gloves
- [73](#) Arm Protection

ABOVE-THE-NECK PROTECTION

- [84](#) Head Protection
- [105](#) Hearing Protection
- [113](#) Respiratory Protection
- [121](#) Eye & Face Protection

BODY PROTECTION

- [146](#) Hi-Vis Apparel
- [167](#) Rainwear
- [178](#) Heated Vest
- [179](#) Apron and Sleeves
- [181](#) ARC Flash and Flame Resistant Protection
- [185](#) Disposable Clothing
- [199](#) Safety Boots

SAFETY AIDS

- [206](#) Heat Stress
- [215](#) Emergency Beacons
- [219](#) First Aid Kits
- [223](#) Ergonomics
- [227](#) Tool Tethering

SAFETY SOLUTIONS SECTION

CHEMICAL & LIQUID PROTECTION

- [232](#) Hand Protection
- [242](#) Head-To-Toe Protection
- [243](#) Eye and Face Protection
- [244](#) Liquid Splash Protection Kits

FOOD SAFETY

- [246](#) Metal Mesh Hand and Arm Protection
- [247](#) Metal Mesh Garments
- [248](#) Hand and Arm Protection
- [254](#) Reusable Arm and Body Protection
- [256](#) Disposable Clothing
- [257](#) Above-the-Neck Protection
- [260](#) Head-To-Toe Protection and Liquid Splash Protection Kits

WELDING SAFETY

- [262](#) Hand Protection
- [275](#) Apparel
- [283](#) Eye and Face Protection
- [285](#) Above-the-Neck Protection

ELECTRICAL SAFETY

- [288](#) New Installations Hand Protection
- [289](#) New Installations Construction Electrical
- [290](#) Rubber Insulating Gloves
- [292](#) AR/FR Clothing and Kits
- [302](#) ARC Flash Accessories

CONTROLLED ENVIRONMENT SAFETY

- [308](#) Hand Protection
- [317](#) Thermal Protection
- [318](#) Dry Box and Isolator Gloves and Sleeves
- [319](#) Cleanroom Accessories
- [320](#) Reusable Garments
- [322](#) Controlled Environment Accessories



Global Provider of Innovative Safe



PROTECTIVE INDUSTRIAL PRODUCTS

Each day, we seek to develop, train and provide our customers with innovative safety products that help keep workers safer, more comfortable and more productive.

We work with our distributor partners to deliver best-in-class customer experiences by providing a comprehensive product offering, world-class sales tools and efficient processes.

Our close-to-home manufacturing facilities enable us to provide safety solutions that are tailored to customer needs. These factories work with our team of product managers, specialists and field quality control technicians to ensure the highest level of product performance and secure proprietary technologies that support us being first-to-market.

Safety Products

EXTENSIVE PRODUCT PORTFOLIO



HAND PROTECTION



ARM PROTECTION



HEAD PROTECTION



CHEMICAL & LIQUID PROTECTION



RESPIRATORY PROTECTION



HEARING PROTECTION



EYE & FACE PROTECTION



PROTECTIVE CLOTHING



RUBBER FOOTWEAR



ERGONOMIC PRODUCTS



HEAT PROTECTION



COLD PROTECTION



FOUNDED IN 1984

LATHAM, NY, USA



WORKFORCE OF 1,000+

GLOBAL EMPLOYEES



5,000+ PRODUCTS

WORLDWIDE



20+ GLOBAL

LOCATIONS



10 MANUFACTURING

LOCATIONS IN NORTH AMERICA



1.3 MILLION SQ. FT

GLOBALLY SITUATED DISTRIBUTION CENTERS



4,000+ CUSTOMERS

WORLDWIDE



OVER \$650 MILLION

IN WORLDWIDE SALES



PROTECTIVE INDUSTRIAL PRODUCTS

Easy ordering solutions

FOR PIP® DISTRIBUTORS

Our Order Management team is made up of knowledgeable, detail-oriented associates who are dedicated to efficient order processing:

EMAIL ORDERS TO:
orders@pipusa.com

DIRECT ONLINE AT:
myPIPUSA.com

CUSTOM LOGO ORDER PROCESSING:
logoexpress@pipusa.com

BY PHONE:
(855) 284-6800

BY FAX:
(518) 861-0144

BY EDI:
**Set up EDI by contacting your
PIP® Regional Sales Manager**

INDUSTRY-LEADING CUSTOMER SERVICE

Our highly experienced Customer Relationship Specialists are dedicated to supporting you on all matters related to order resolution, open orders, inventory, samples and pricing. They are backed by a Technical Support Team that assists with technical questions including specifications, product applications and cross-references.

CALL:
(855) 284-6800

EMAIL:
customerservice@pipusa.com

Hand and Arm PROTECTION

PIP® is committed to developing and providing hand and arm protection products that deliver maximum performance in the harshest conditions and in the widest array of applications.



CUT HAZARDS



IMPACT HAZARDS



MECHANICAL HAZARDS



INSULATED/COLD HAZARDS

14

COATED SEAMLESS KNIT CUT RESISTANT GLOVES are specifically designed to improve grip performance and protection against risks while handling sharp objects such as blades, glass or metals. ANSI/ISEA 105:2016 and EN 388:2016 standards provide guidance to compare the performance characteristics of each style of glove.

25

UNCOATED SEAMLESS KNIT CUT RESISTANT GLOVES do not have any coating material. Gloves made from aramid blended yarns provide cut resistance and heat defense. HPPE blended yarns provide cut resistance, cool comfort and sanitized launderability for critical food handling applications.

35

COATED SEAMLESS KNIT GENERAL PURPOSE GLOVES are designed to provide hand coverage and grip. Liner materials are typically acrylic, cotton, polyester or nylon blends that are comfortable but offer no measurable cut resistant properties.

45

GENERAL PURPOSE FABRIC WORK GLOVES are offered in a wide variety of materials, grades and styles. Cotton and canvas gloves are constructed of woven fabric cloth and come in a variety of weights and styles, to provide soft, flexible comfort and good overall wear. Chore and jersey gloves are lightweight gloves used to keep hands clean and protect against scrapes and abrasions in low-risk work applications.

58

LEATHER DRIVERS AND LEATHER PALM GLOVES are versatile, economical and durable providing comfort and protection against abrasion. Leather comes in a variety of styles, designs and grades, each offering unique characteristics for different jobs. Leather gloves provide no measurable cut resistance properties unless lined with a cut resistant liner.

67

HIGH PERFORMANCE TASK-SPECIFIC GLOVES use advanced, composite materials and purpose built to deliver a higher level of performance in the specialized conditions. They include impact-resistant, AR/FR, mechanics and task-specific styles.

73

PROTECTIVE SLEEVES help keep arms and wrists safe from cuts and abrasion in a variety of applications. Depending on the specific needs required, sleeves can be designed at various lengths and with different materials that can offer high cut resistance as well as light heat resistance.



CUT PROTECTION MATERIAL BASICS

Technology platforms

ADVANCED CUT RESISTANT FIBER AND YARN TECHNOLOGIES

Protection workers want to wear.

THAT'S OUR GOAL.



It's about more than just cut protection. It is about cut protection that meets every need. G-Tek® represents the safety industry's most comprehensive line of coated seamless knit gloves.

For over 30 years PIP® has invested in G-Tek® products, evolving them from simple cotton knits to the most advanced gloves that combine engineered yarns, advanced ergonomic design and coating elastomers.

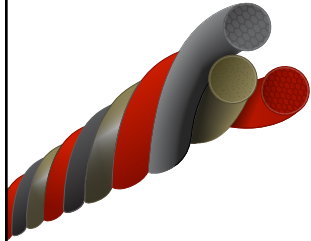

PolyKor®

PROTECTION. PERFORMANCE. VALUE.

PolyKor® engineered yarns optimize performance, function and protection using proprietary blends of select fibers to exceed industry standards. The ultimate objective is an affordable array of cut resistant gloves for practically every application.



PolyKor®
X7™ TECHNOLOGY

HIGH DEXTERITY. MAXIMUM CUT RESISTANCE.

X7™ technology is the latest in engineered yarn development. This super lightweight reinforced yarn provides very high cut resistance and durability by way of proprietary fibers.

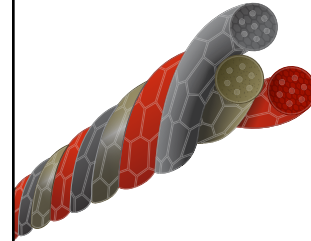

PolyKor®
XCRYSTAL™

STRONGEST. TOUGHEST. HARDEST.

Xrystal™ technology represents the latest in PolyKor® engineered yarns that are combined with naturally hardened crystallized minerals. The result is a super tough, durable, cut resistant fiber that is at the peak of performance.

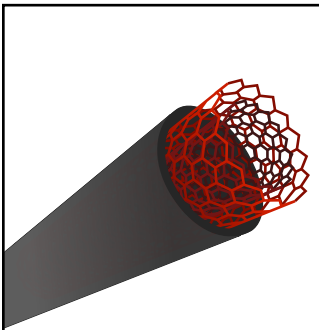
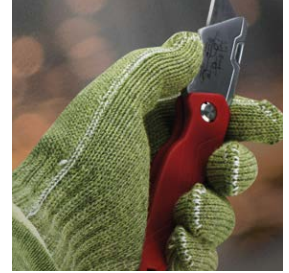

Suprene™

**TOUGH.
RESISTANT.
DURABLE.**

The latest breakthroughs in nanofabrication has resulted fibers containing graphene material which we call Suprene™. Suprene™ is an high performance yarn that offer unparalleled strength and physical properties that are unique to graphene.

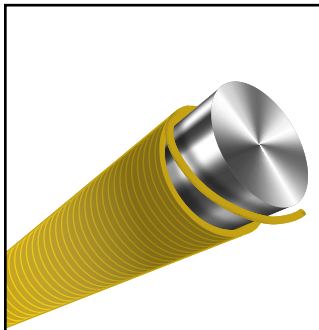

KEV™

**CUT AND HEAT
RESISTANCE.**

Combines the power of DuPont® Kevlar® with proprietary core technology for exceptional cut strength and protection in light heat applications.

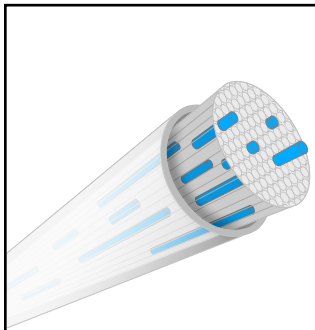

3GX®

**UNMATCHED
COMFORT. IMPROVED
CUT PROTECTION.**

Dyneema® Diamond advanced technology of embedded micro-particles strengthen fibers by up to two times, delivering higher cut scores. 3GX® Technology offers cool touch comfort and lightweight durability for improved productivity.

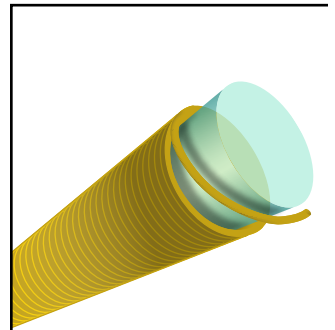

ACP™ TECHNOLOGY

**MAXIMUM CUT
RESISTANCE
NO SKIN IRRITATION**

ACP™ are proprietary yarn formulations that use encapsulated glass fibers to maximize cut resistance and eliminate skin irritation.



COATING BASICS

A complete line of coatings

UNMATCHED IN SELECTION AND PERFORMANCE

NEOFOAM®

SECURE HANDLING OF LIGHT TO HEAVY PARTS OR ITEMS

Proprietary coating only available on G-Tek® brand gloves. NeoFoam® is a highly flexible coating that provides wearers with a high degree of grip, hand dexterity and comfort. NeoFoam® is versatile, hardworking, resistant to light oils and touchscreen compatible with most devices, making G-Tek® NeoFoam® coated gloves the optimal choice for numerous handling applications.

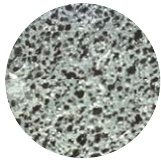

MICROSURFACE

Coating surface infused with thousands of tiny suction cup pockets. When pressed into contact with a wet or oily surface, they create a vacuum effect that disperses fluids away – significantly improving grip.

- > Good grip in dry, wet, or oily conditions

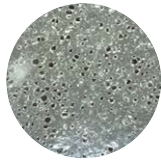

FOAM

Foam coating cell structure is designed to channel fluids away from the surface of the object generating grip in oily conditions. Oily grip effectiveness varies with density of cells.

- > Secure grip in dry conditions
- > Fair grip in slightly oil or wet conditions

NITRILE

TOUGH COATING FOR HEAVY-DUTY JOBS

Nitrile is a synthetic rubber compound that offers excellent puncture, tear and abrasion resistance. Nitrile is also known for its resistance to hydrocarbon-based oils or solvents. Nitrile coated gloves are the first choice for industrial jobs which require handling of oily parts. Nitrile is durable and helps to maximize protection.

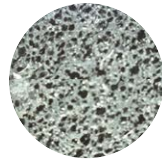

MICROSURFACE

Coating surface infused with thousands of tiny suction cup pockets. When pressed into contact with a wet or oily surface, they create a vacuum effect that disperses fluids away – significantly improving grip.

- > Good grip in dry, wet, or oily conditions

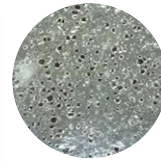

FOAM

Foam coating cell structure is designed to channel fluids away from the surface of the object helping improve grip in oily conditions. Oily grip effectiveness varies with density of cells.

- > Secure grip in dry conditions
- > Fair grip in slightly oil or wet conditions



FLAT / SMOOTH

Flat/Smooth coatings provide the wearer with a secure dry grip. Liquids will not absorb into the coating, keeping hands dry and clean.

- > Secure, tacky grip for dry surfaces

Maximum dexterity and comfort. Exceptional durability.



ATG® NITRILE

PREMIUM COATING FOR PREMIUM PERFORMANCE

Proprietary ATG® Nitrile Butadiene Rubber formulation is applied precisely and thinly over the glove liner to all MaxiFlex® and MaxiCut® gloves, delivering maximum dexterity and flexibility. The coating is exceptionally durable and long-lasting.

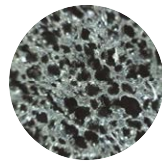

MICROFOAM

MicroFoam is a patented formulation of ATG's nitrile coating that allows gloves to be thinly coated for added grip, dexterity, comfort and breathability.

- > Controlled grip in dry and in slightly oily conditions
- > Premium comfort & flexibility



LATEX

TOUGH JOBS — DRY OR OILY-WET

Latex is a natural rubber that is flexible, tough and durable, delivering a high degree of resistance to snagging, puncture and abrasion. Latex is water-resistant as well as resistant to protein-based oils. Latex is not recommended for jobs that involve contact with hydrocarbon-based oils or solvents.



CRINKLE

Crinkle coatings have creases or wrinkles on the surface of the coating that are designed to channel fluids away and allow better contact on dry or wet surfaces.

-> Secure grip in dry or wet conditions

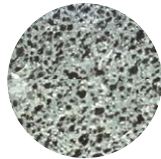

MICROSURFACE

Coating surface infused with thousands of tiny suction cup pockets. When pressed into contact with a wet or slippery surface, they create a vacuum effect that disperses fluids away – significantly improving grip.

-> Good grip in dry and wet or oily-wet surfaces.

POLYURETHANE

IDEAL FOR PRECISION HANDLING AND LIGHT TO MEDIUM DUTY JOBS

Polyurethane (PU) is a tough, proven material that offers good tactile sensitivity by way of its thin material deposit. It conforms intimately over multiple glove liners to provide flexibility, dexterity and tactile sensitivity. PU coated gloves are amongst the most commonly used because they are versatile and provide excellent value. Newer, water-based PU coatings offer improved flexibility and less environmental lifecycle impact.



FLAT / TEXTURED

Flat/Textured PU takes on the surface properties of the glove liner which results in the thin, conformable deposit of coating material. The flat, textured nature of this coating is unique to Polyurethane (PU) coated gloves.

-> Tactile grip in dry and in slightly oily conditions

COATING	GRIP	1	2	Fair	Good	Secure	Fair	Good	Secure	Fair	Good	Secure	None	Limited	Good	None/ Slight	Fair	Good	Low	Medium	High	None	Minimal	High
		LAYERS	DRY GRIP			SLIGHTLY WET GRIP			OILY SURFACES GRIP			TOUCHSCREEN*			BREATHABILITY			DURABILITY			LIQUID RESISTANCE			
NeoFoam [®]	Foam	•				•	•			•					•		•			•			•	
	Microsurface	•				•		•			•				•	•					•			•
Nitrile	Microsurface		•		•		•				•			•		•					•			•
	Microsurface	•			•		•				•			•		•				•				•
	Foam	•			•				•					•			•				•			•
	Flat/Smooth	•				•							•			•				•				•
ATG [®] Nitrile	MicroFoam	•			•			•			•			•			•				•		•	
Latex	Microsurface		•			•		•			•		•			•					•			•
	Microsurface	•				•		•			•		•			•					•			•
	Crinkle	•				•		•		•			•			•					•			•
Polyurethane	Flat / Textured	•			•		•			•				•	•			•					•	

RESISTIVE TOUCHSCREENS, found on most industrial controls, rely on pressure and are unaffected by the use of gloves. CAPACITIVE TOUCHSCREENS, typically used with tablets, smartphones and laptops rely on the electrical field effect from our finger. PIP[®] trials have found that many of our coated seamless knit gloves with thinner black coatings will work with today's latest mobile devices. However, we recommend trials prior to equipping teams with gloves. For guaranteed bare finger precision and sensitivity on any device, we provide the PU coated G-Tek[®] 33-GT125, featuring conductive fingertip touch technology.

HAND PROTECTION

Understanding cut and impact protection

PIP® GLOVES ARE TESTED TO ANSI AND EN STANDARDS

Both standards test gloves for abrasion, cut, tear and puncture. U.S. safety managers know to choose products that are tested and labeled in order to ensure the best possible protection for the job being performed.

ANSI-105 AMERICAN NATIONAL STANDARD

This standard has established ASTM F2992-15 as the test method for measuring cut resistance on a 9-level scale with the widely recognized TDM 100 machine that uses a linear sliding blade.

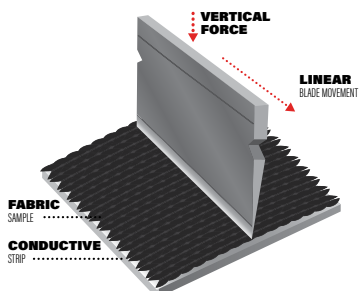

ANSI A1 200 - 499	ANSI A2 500 - 999	ANSI A3 1000 - 1499 GRAMS	ANSI A4 1500 - 2199	ANSI A5 2200 - 2999
ANSI A6 3000 - 3900	ANSI A7 4000 - 4900	ANSI A8 5000 - 5900 GRAMS	ANSI A9 > 6000	

EN 388 EUROPEAN CUT STANDARD (CE)

This standard allows for two different testing standards and methods: The Coup Test using a rotating circular blade and the TDM Test using a linear sliding blade using the ISO 13977 method.

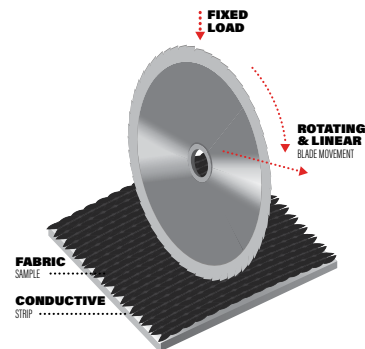

EN 1 1.2 - 2.4	EN 2 2.5 - 4.9	EN 3 5.0 - 9.9	EN 4 10.0 - 19.9	EN 5 > 20
AVERAGE CUT INDEX (10 MEASUREMENTS)				

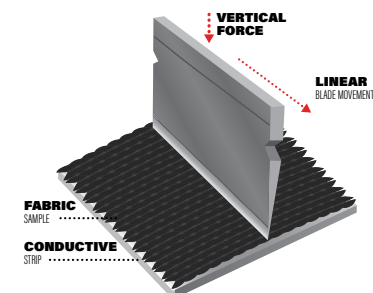

EN A 2 - 4.9	EN B 5 - 9.9	EN C 10 - 14.9	EN D 15 - 21.9	EN E 22 - 29.9	EN F 30+
RANGE (NEWTONS)					

Protection



ANSI-105-2016
STANDARD



EN388
2016 STANDARD



ANSI-138-2019
STANDARD

EN 388 PERFORMANCE MARKINGS

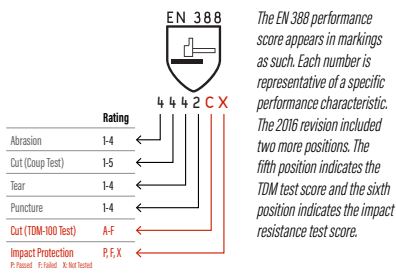

COMPARING TDM TEST ANSI 105 TO EN 388

Below is a graph that illustrates how the new EN TDM-100 test aligns closely with the ANSI cut test. The table below the graph outlines the full details of the scores and when converting Newtons to grams.

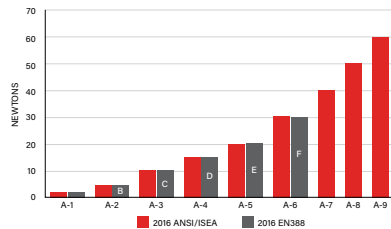

CONVERTING NEWTONS TO GRAMS

EN 388 RATING	RANGE (NEWTONS)	CONVERTED RANGE (GRAMS)	ANSI/ISEA RES. LEVEL	RANGE (GRAMS)
A	2-49	204-508	A1	200-499
B	5-99	500-1019	A2	500-999
C	10-149	1,020-1,529	A3	1,000-1,499
D	15-219	1,530-2,242	A4	1,500-2,399
E	22-299	2,243-3,058	A5	2,200-2,999
F	30+	3,059+	A6	3,000-3,999
---	---	---	A7	4,000-4,999
---	---	---	A8	5,000-5,999
---	---	---	A9	6,000+

IMPACT RESISTANT GLOVE STANDARD (2019 EDITION) ANSI/ISEA 138 - 2019

The ANSI/ISEA 138 2019 Impact Resistant Glove Standard was developed to better classify the impact resistance of gloves, making it easier than ever to choose the right impact glove for any application. This standard considers the minimum performance, classification and labeling requirements for material protecting the fingers and knuckles from impact.

UNDERSTANDING ANSI/ISEA 138-2019 TESTING

ANSI/ISEA 138-2019 outlines three levels of impact protection. Each level is determined by how effectively each glove can disperse impactful force applied during testing. The way this impactful force is created is by dropping a 2.5-kilogram mass onto each glove with an impact energy of 5 joules. This process is repeated ten times on the fingers and eight times on the knuckles. The glove's impact level will then be determined based on the Mean Transmitted Force (MTF) recorded.

It is important to note that the MTF of the finger region is treated separately from that of the knuckle region, so the lower mean transmitted force of the two regions will be used to classify the glove as a whole.

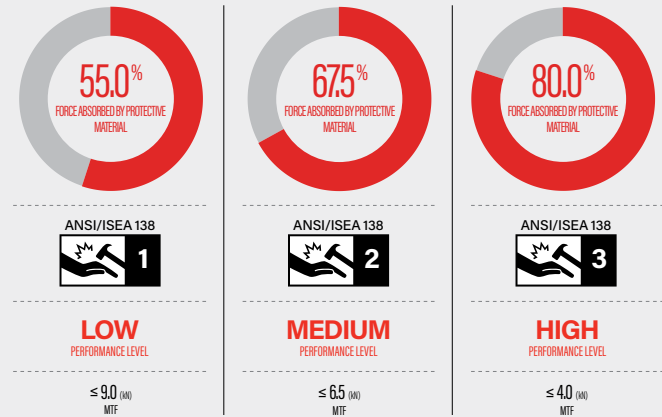
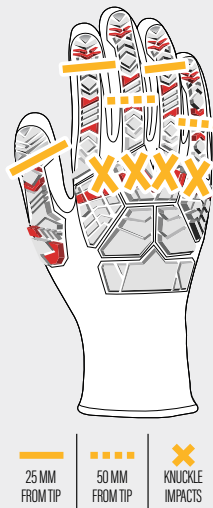

GLOVE MARKINGS AND NEW ICONS

PIP® Impact resistant gloves now display the ANSI/ISEA 138-2019 symbol in accordance to its level. The symbol is printed next to the ANSI cut score on a tag located inside of the wrist of the glove.

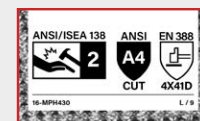

TAG INSIDE OF GLOVE



PROTECTIVE INDUSTRIAL PRODUCTS

Cut Risk Hazard Matrix™

CHOOSING THE RIGHT HAND PROTECTION

YOUR GUIDE TO THE RIGHT CHOICE

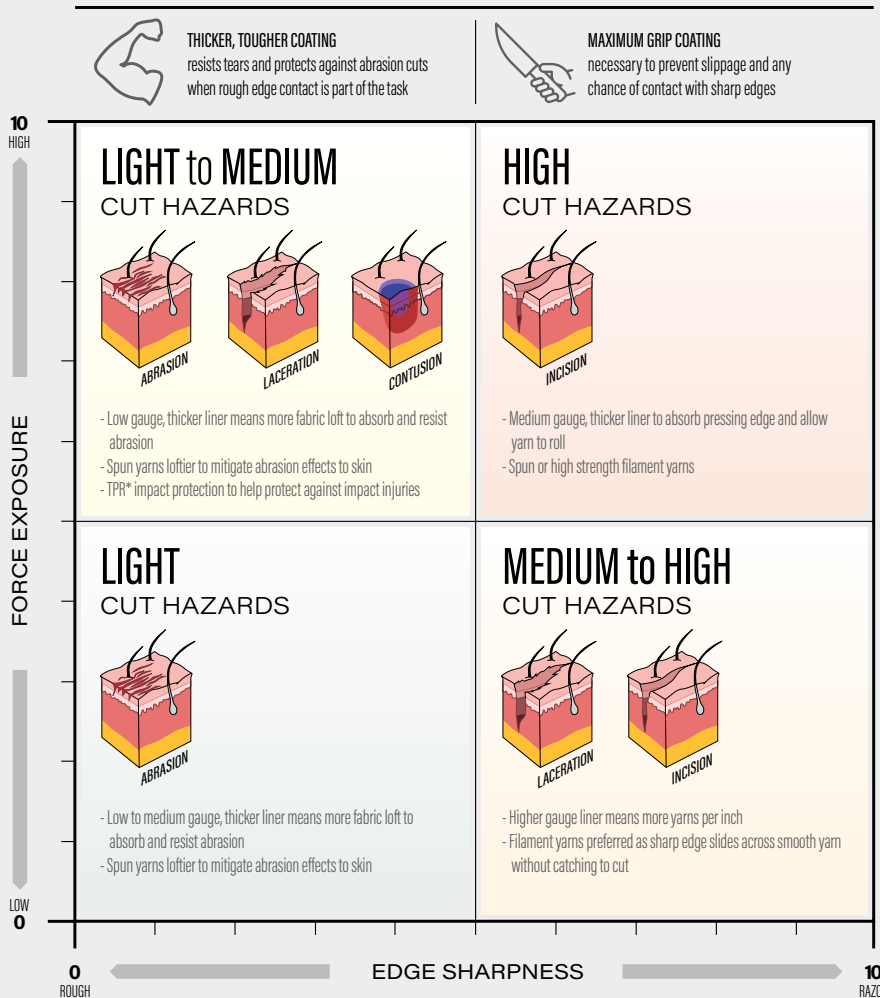

Cut Risk Hazard Matrix™

The Cut Risk Hazard Matrix™ is a unique and logical method to guide users in selecting a glove or sleeve with the right cut resistant material and score. Once a safety manager can identify where their application fits on the Cut Risk Hazard Matrix™, they can more confidently correlate the task to the glove or sleeve best suited for their job.



We deemed it necessary to develop a unique approach to help determine the risk and possible severity of an injury.

CALCULATING THE CRH: FACTOR™

1. Assess the EDGE SHARPNESS with "Rough" equating to the edge of a brick and "Razor" to that of a sharp knife.
2. FORCE is relative to the different tasks being performed. Tasks such as deboning large animals require a high degree of force compared to working with box cutters in a repacking operation.
3. Mapping the two will place you in one of the four quadrants of RISK where you can determine your CRH: Factor™ and proceed to selecting the optimal coating for maximum grip.

Copyright © 2017. Protective Industrial Products, Inc. All rights reserved.



WE'VE EQUATED CUT SCORE FACTORS WITH REAL-WORLD TASKS AND APPLICATIONS AS EXAMPLES

By plotting the tasks and applications, we determine a **Cut Risk Hazard Factor™** (CRH: Factor™) as outlined on the right side. The CRH: Factor™ is a comparative indicator that helps safety managers determine the level of potential hazard related to the task or application.

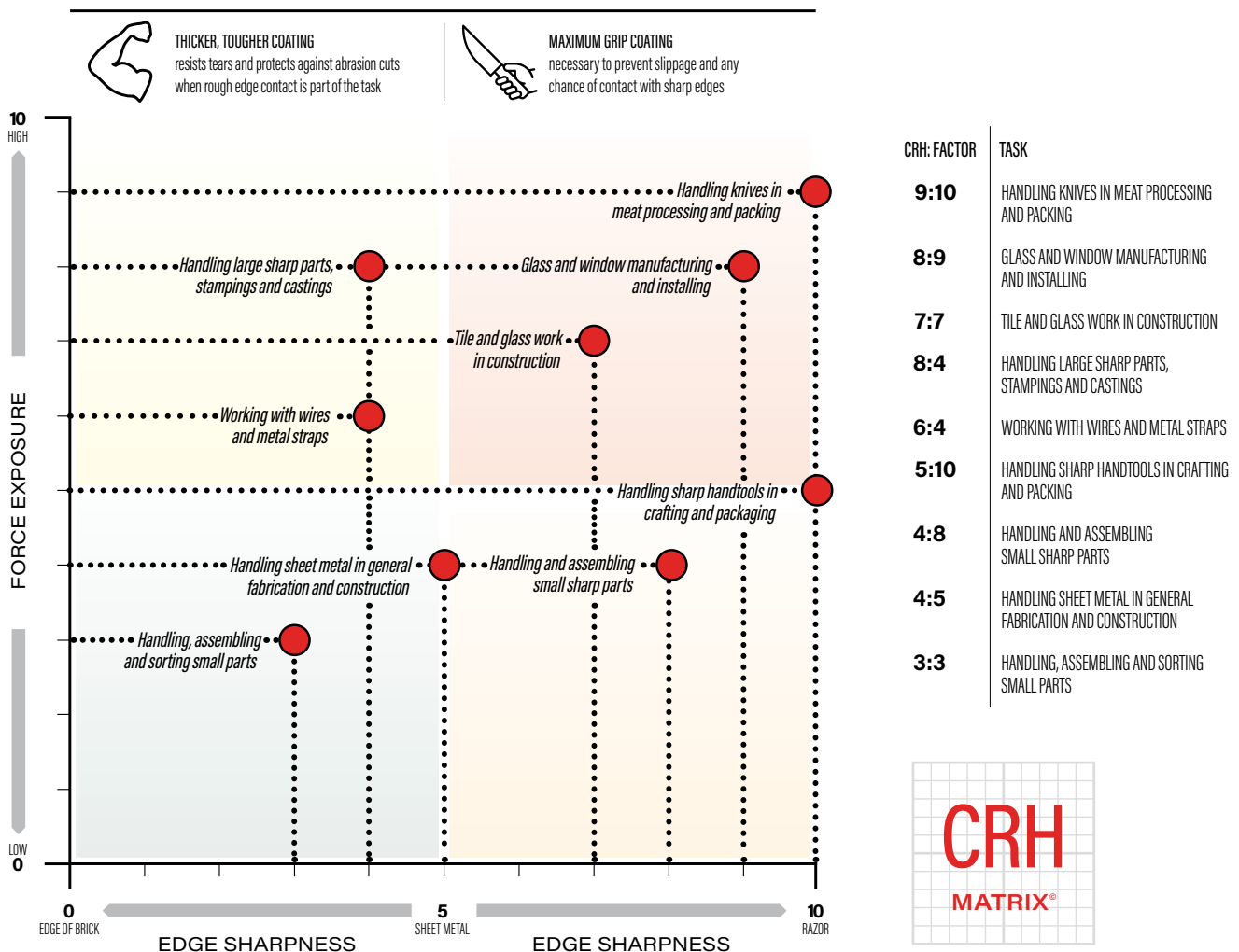



Scan it



NeoFoam®



SECURE
DRY & FLEXIBLE GRIP



Handling, Assembly and Sorting of Small to Medium Parts and Materials
Shipping, Receiving and Packaging / Ideal for Maintenance and Repair Operations

ANSI
A9



16-399
- Highest rated cut protection available
- MicroSurface finish provides medium durability and good grip on oily surfaces

NEW

ANSI
A9 ANSI/ISEA 138



16-MP935
- Highest rated cut resistant fiber available
- Ideal for applications that require high cut and impact protection

IMPACT PROTECTION

ANSI
A7



16-377
- Lightweight coating and liner provides dexterity and tactile sensitivity
- Ideal for handling and assembly of sharp parts and materials

TOP SELLER

ANSI
A7 ANSI/ISEA 138



16-MP785
- Lightweight coating and liner provides dexterity and tactile sensitivity
- Ideal for applications that require high cut and impact protection

IMPACT PROTECTION

ANSI
A5 ANSI/ISEA 138



16-MP585
- Lightweight coating and liner provides dexterity and tactile sensitivity
- Ideal for applications that require medium cut and impact protection

IMPACT PROTECTION

ANSI
A5



16-X580
- Highly durable cut resistant fiber
- Dark liner and coating hides dirt

16-X585 features a reinforced thumb crotch

REINFORCED THUMB CROTCH

ANSI
A4



15-440
- Remarkably strong fiber with high resistance to cut and tear
- Ideal for metal handling and fastening jobs

ANSI
A4



16-X570
- Highly durable cut resistant fiber
- Ideal for heavy and general duty applications

16-X575 features a reinforced thumb crotch

ANSI
A3



09-K1218
- Lightweight coating and liner provides dexterity and tactile sensitivity
- Resistant to light heat and spark

ANSI
A3



16-368
- Lightweight coating and liner provides dexterity and tactile sensitivity
- Highly versatile glove with reinforced wear points good for a variety of handling applications

DEXTERITY AND CUT

ANSI
A2



16-320
- Lightweight coating and liner provides dexterity and tactile sensitivity
- Form and fit provide bare hand-like dexterity

NeoFoam® is a highly flexible coating that provides wearers with a high degree of grip, hand dexterity and comfort



TOUCHSCREEN COMPATIBLE

STYLE	ANSI CUT	EN388	ANSI/ISEA 138	COATING	COATING COVERAGE	COATING COLOR	LINER	LINER COLOR	GAUGE	SIZES	PROP 65
09-K1218	A3	4331CX	-	NeoFoam®	Palm & Fingers	Black	Kevlar®	Gray	18	S-2XL	-
15-440	A4	4542DX	-	NeoFoam®	Palm & Fingers	Black	Supreme®	Tan	13	XS-2XL	-
16-320	A2	4X41BX	-	NeoFoam®	Palm & Fingers	Blue	PolyKor® XT™	Blue	18	XS-2XL	-
16-368	A3	4X31CX	-	NeoFoam®	Palm & Fingers	Black	PolyKor® XT™	Burgundy	18	S-2XL	-
16-377	A7	4X42FX	-	NeoFoam®	Palm & Fingers	Black	PolyKor® XT™	Black	18	XS-2XL	-
16-399	A9	4X43FX	-	NeoFoam® MicroSurface	Palm & Fingers	Black	PolyKor® XT™	Green	13	S-2XL	-
16-MP585	A5	4X42EP	Impact Level 1	NeoFoam®	Palm & Fingers	Black	PolyKor® XT™	Blue	18	M-2XL	-
16-MP785	A7	4X42FP	Impact Level 1	NeoFoam®	Palm & Fingers	Black	PolyKor® XT™	Black	18	M-2XL	-
16-MP935	A9	4X43FP	Impact Level 1	NeoFoam® MicroSurface	Palm & Fingers	Black	PolyKor® XT™	Green	13	M-2XL	-
16-X570	A4	4542DX	-	NeoFoam®	Palm & Fingers	Black	PolyKor® Xrystal™	Gray	13	XS-2XL	-
16-X575	A4	4542DX	-	NeoFoam®	Palm & Fingers	Black	PolyKor® Xrystal™	Gray	13	XS-2XL	-
16-X580	A5	4X42EX	-	NeoFoam®	Palm & Fingers	Black	PolyKor® Xrystal™	Black	13	S-2XL	-
16-X585	A5	4X42EX	-	NeoFoam®	Palm & Fingers	Black	PolyKor® Xrystal™	Black	13	S-2XL	-

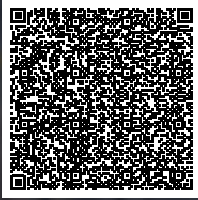

Scan it



Nitrile



SECURE DRY GRIP AND OIL RESISTANT

Handling and Assembly of Medium to Large Parts and Materials / Metal Fabrication
Mechanical Equipment Maintenance and Repair / Heavy to Medium Fastening and Anchoring



 <p>ANSI A7</p> <p>16-278</p> <ul style="list-style-type: none"> - Ultra-lightweight 18-gauge liner delivers outstanding dexterity and tactile sensitivity - Touchscreen compatible <p>NEW</p>	 <p>ANSI A7</p> <p>16-373</p> <ul style="list-style-type: none"> - Medium weight breathable and durable glove liner - Nitrile foam coating resists contact with common industrial oils and solvents <p>NEW</p>	 <p>ANSI A7</p> <p>16-378</p> <ul style="list-style-type: none"> - Ultra-lightweight 18-gauge liner delivers outstanding dexterity and tactile sensitivity - Nitrile foam coating resists contact with common industrial oils and solvents <p>NEW</p>	 <p>ANSI A7</p> <p>09-K1600</p> <ul style="list-style-type: none"> - Resistant to light heat and spark - Handling heavy sharp parts in oily environments <p>TOP SELLER</p>
 <p>ANSI A6</p> <p>1CF7007N</p> <ul style="list-style-type: none"> - Padded anti-vibratory palm - Economically priced with premium features - Tough, flexible coating provides resistance to liquids and oils <p>IMPACT PROTECTION</p>	 <p>ANSI A6</p> <p>1CF7007NTPR</p> <ul style="list-style-type: none"> - TPR back-of-hand impact protection - Padded anti-vibratory palm - Tough sandy nitrile coating provides excellent puncture, tear and abrasion resistance <p>IMPACT PROTECTION</p>	 <p>ANSI A5</p> <p>16-635</p> <ul style="list-style-type: none"> - Comfortable and flexible - Medium duty blended shell ideal for manufacturing and assembly 	 <p>ANSI A5</p> <p>16-655</p> <ul style="list-style-type: none"> - Double-dipped coating resists oil penetration - Salt and pepper liner with dark coating <p>DOUBLE-DIPPED</p>
 <p>ANSI A5 ANSI/ISEA 138 2</p> <p>16-MPH430</p> <ul style="list-style-type: none"> - High-density TPR panels with flexible design reduces hand fatigue - Tough wearing glove for heavy-duty applications <p>IMPACT PROTECTION</p>	 <p>ANSI A5</p> <p>555</p> <ul style="list-style-type: none"> - Ultra-lightweight 18-gauge liner delivers outstanding dexterity and tactile sensitivity - Touchscreen compatible - Reinforced thumb crotch 	 <p>ANSI A5</p> <p>16-354</p> <ul style="list-style-type: none"> - Medium weight breathable and durable glove liner - Coating provides excellent puncture, tear and abrasion resistance 	 <p>ANSI A4</p> <p>09-K1630</p> <ul style="list-style-type: none"> - Resistant to light heat and spark - Nitrile foam coating resists contact with common industrial oils and solvents - Dark liner and coating hides dirt <p>LIGHT HEAT RESISTANCE</p>

RESISTANT TO SNAG, CUT, PUNCTURE & ABRASION

STYLE	ANSI CUT	EN388	ANSI/ISEA 138	COATING	COATING COVERAGE	COATING COLOR	LINER	LINER COLOR	GAUGE	SIZES	PROP 65
09-K1600	A7	4532FX	-	Nitrile Foam	Palm & Fingers	Black	Kevlar®	Yellow	13	S-3XL	-
09-K1630	A4	4X31DX	-	Nitrile Foam	Palm & Fingers	Black	Kevlar®	Gray	13	S-2XL	-
15-210	A4	4544DX	-	Nitrile MicroSurface	Palm & Fingers	Black	Supreme®	Tan	13	XS-2XL	⚠️ C&R
15-215	A4	4544DX	-	Nitrile MicroSurface	Palm, Fingers & Knuckles	Black	Supreme®	Tan	13	XS-2XL	⚠️ C&R
16-278	A7	4X42FX	-	Nitrile MicroSurface	Palm & Fingers	Black	PolyKor™ XT™	Salt & Pepper	18	XS-2XL	-
16-373	A7	4X43FX	-	Nitrile Foam	Palm & Fingers	Black	PolyKor™	Salt & Pepper	13	XS-2XL	-
16-354	A5	4X43E	-	Nitrile Foam	Palm & Fingers	Black	PolyKor™	Black	13	XS-2XL	-
16-378	A7	4X42FX	-	Nitrile Foam	Palm & Fingers	Black	PolyKor™ XT™	Salt & Pepper	18	XS-2XL	-
16-635	A5	4X42EX	-	Nitrile MicroSurface	Palm & Fingers	Black	PolyKor™	Blue	13	S-2XL	-
16-655	A5	4X42EX	-	Nitrile MicroSurface	Palm & Fingers	Black	PolyKor™	Salt & Pepper	13	S-2XL	-
16-MPH430	A5	4X42EP	Impact Level 2	Nitrile MicroSurface	Palm & Fingers	Black	PolyKor™	Gray	13	M-2XL	-
1CF7007N	A6	3542	-	Nitrile Sandy	Palm & Fingers	Black	HPPE, Insulated	Hi-Vis Orange	13	S-XXL	⚠️ C&R
1CF7007NTPR	A6	3542	-	Nitrile Sandy	Palm & Fingers	Black	HPPE/Glass/Poly/Spandex	Hi-Vis Green	13	S-XXL	⚠️ C&R
555	A5	4X41E	-	Nitrile Foam	Palm & Fingers	Black	PolyKor™	Gray	18	XS-2XL	-

C ⚠️ **WARNING:** Cancer - www.P65Warnings.ca.gov R ⚠️ **WARNING:** Reproductive Harm - www.P65Warnings.ca.gov C&R ⚠️ **WARNING:** Cancer and Reproductive Harm - www.P65Warnings.ca.gov



G-TEK® NITRILE COATED SEAMLESS KNIT CUT RESISTANT GLOVES

 ANSI A4 16-854 - Ultra-lightweight 18-gauge liner delivers outstanding dexterity and tactile sensitivity - Touchscreen compatible TOUCHSCREEN COMPATIBLE	 ANSI A4 16-350 - Double-dipped coating resists oil penetration - Salt and pepper liner with dark coating hides dirt TOP SELLER	 ANSI A4 19-D340LG - Durable and affordable - Hi-vis color helps with hand-to-eye coordination HI-VISIBILITY	 ANSI A4 19-D534B - Light, cool, flexible feel - Dark liner and coating hides dirt LIGHT HEAT RESISTANCE
 ANSI A4 41-1417 - 15-gauge PolyKor® shell with 7-gauge acrylic lining provides thermal insulation - Double-dipped full hand coating provides liquid protection EXTENDED COVERAGE	 ANSI A3 41-1415 - Hi-wrist for added visibility in poor conditions - Double-dipped full hand coating provides liquid protection EXTENDED COVERAGE	 ANSI A4 HVG713SNF - Padded palm - Excellent protection in oily and rugged applications TOUCHSCREEN COMPATIBLE	 ANSI A4 HVG713SNFPP - Highly versatile glove with the reinforced wear points - Ideal for chaining and rigging, working with heavy wire - Touchscreen compatible PADDED PALM
 ANSI A3 16-3450R - Raised micro-dots on palm and fingers provide cushioning and improved abrasion resistance - Reinforced thumb runs from thumb up the index finger THUMB AND INDEX REINFORCED	 ANSI A3 09-K1618 - Dark liner and coating hides dirt - Glove liner offers light heat resistance LIGHT HEAT RESISTANCE	 ANSI A3 16-333 - Coating ideal for handling oily parts - Medium duty blended shell ideal for manufacturing and assembly NEW	 ANSI A3 16-340LG - Moving heavy parts where visibility is required - Double-dipped coating resists oil penetration HI-VISIBILITY
 ANSI A3 710SANF - Resistant to light heat and spark - High abrasion resistance LIGHT HEAT RESISTANCE	 ANSI A4 16-CUT229MS - Medium weight breathable and durable glove liner - Double-dipped and fully coated for excellent oil and liquid resistance NEW	 ANSI A4 16-939 - Lightweight coating and liner provides dexterity and tactile sensitivity - Double-dipped and fully coated for excellent oil and liquid resistance NEW	 ANSI A3 19-D334 - Light, cool, flexible feel - Affordable value NEW

STYLE	ANSI CUT	EN388	ANSI/ISEA 138	COATING	COATING COVERAGE	COATING COLOR	LINER	LINER COLOR	GAUGE	SIZES	PROP 65
09-K1618	A3	4421CX	-	Nitrile Foam	Palm & Fingers	Black	Kevlar®	Gray	18	S-2XL	-
16-333	A3	4X42CX	-	Nitrile MicroSurface	Palm & Fingers	Black	PolyKor™	Salt & Pepper	13	XS-2XL	-
16-340LG	A3	4544CX	-	Nitrile MicroSurface	Palm & Fingers	Black	PolyKor™	Hi-Vis Yellow	13	S-2XL	-
16-340OR	A3	4544CX	-	Nitrile MicroSurface	Palm & Fingers	Black	PolyKor™	Hi-Vis Orange	13	S-2XL	-
16-3450R	A3	4X44CX	-	Nitrile MicroSurface	Palm & Fingers	Black	PolyKor™	Hi-Vis Orange	13	XS-XL	-
16-350	A4	4543DX	-	Nitrile MicroSurface	Palm & Fingers	Black	PolyKor™	Salt & Pepper	13	XS-2XL	-
16-854	A4	4X42D	-	Nitrile Foam	Palm & Fingers	Black	PolyKor™	Salt & Pepper	18	XS-2XL	-
16-939	A4	4X42CX	-	Nitrile MicroSurface	Full Hand	Black	PolyKor™ X7™	Blue	18	S-2XL	-
16-CUT229MS	A4	4X43DX	-	Nitrile MicroSurface	Full Hand	Black	PolyKor™	Blue	13	XS-2XL	-
16-X310	A4	4544DX	-	Nitrile MicroSurface	Palm & Fingers	Black	PolyKor™ Xrystal™	Gray	13	XS-2XL	⚠️ C&R
16-X320	A4	4543DX	-	Nitrile MicroSurface	Palm & Fingers	Black	PolyKor™ Xrystal™	Gray	13	XS-2XL	⚠️ C&R
19-D334	A3	4443CX	-	Nitrile Foam	Palm & Fingers	Black	Dyneema® Diamond	Salt & Pepper	13	S-2XL	-
19-D340LG	A4	4544DX	-	Nitrile Foam	Palm & Fingers	Black	Dyneema® Diamond	Hi-Vis Yellow	13	XS-2XL	-
19-D340OR	A4	4544DX	-	Nitrile Foam	Palm & Fingers	Black	Dyneema® Diamond	Hi-Vis Orange	13	XS-2XL	-
19-D534B	A4	4543CX	-	Nitrile Foam	Palm & Fingers	Black	Dyneema® Diamond	Black	13	M-XL	-
41-1415	A3	4X32C	-	Nitrile Foam	Full Hand	Black	PolyKor™	Hi-Vis Yellow	15 shell/7 liner	S-2XL	-
41-1417	A4	4X32D	-	Nitrile Foam	Full Hand	Black	PolyKor™	Black	15 shell/7 liner	S-2XL	-
710SANF	A3	4533CX	-	Nitrile Foam	Palm & Fingers	Black	Aramid Blend	Green	10	XS-2XL	-
HVG713SNF	A4	4X42D	-	Nitrile Sandy	Palm & Fingers	Black	HPPE Blend	Hi-Vis Yellow	13	S-2XL	-
HVG713SNFPP	A4	4X42D	-	Nitrile Sandy	Palm & Fingers	Black	HPPE Blend	Hi-Vis Yellow	13	S-2XL	-

⚠️ **WARNING:** Cancer - www.P65Warnings.ca.gov ⚠️ **WARNING:** Reproductive Harm - www.P65Warnings.ca.gov ⚠️ **WARNING:** Cancer and Reproductive Harm - www.P65Warnings.ca.gov



 <p>ANSI A3 19-D355 - Extended coating coverage to knuckle for heavy-duty applications - High abrasion resistance</p> <p>EXTENDED COVERAGE</p>	 <p>ANSI A3 730TBN - Strong wearing, comfortable fit - Secure dry grip will not absorb liquids into coating</p>	 <p>ANSI A3 1CF7006FTPR - Ideal for applications that require dexterity, and back-of-hand impact protection - Economically priced glove with premium features</p> <p>IMPACT PROTECTION</p>	 <p>ANSI A2 09-K1400 - Resistant to light heat and spark - Smooth coating provides a secure dry grip and additional liquid protection on wrist</p> <p>LIGHT HEAT RESISTANCE</p>
 <p>ANSI A2 09-K1450 - Resistant to light heat and spark - Secure dry grip ideal for small parts handling and assembly applications</p> <p>LIGHT HEAT RESISTANCE</p>	 <p>ANSI A2 09-K1650 - Resistant to light heat and spark - MicroFinish® coating is ideal for applications that require a secure wet grip</p> <p>LIGHT HEAT RESISTANCE</p>	 <p>ANSI A2 09-K1660 - Double-dipped coating resists oil penetration - Glove liner offers light heat resistance</p> <p>LIGHT HEAT RESISTANCE</p>	 <p>ANSI A2 16-323 - Hi-Vis liner for added visibility - Thin 15-gauge offers increased dexterity ideal for assembly and parts inspection</p> <p>HI-VISIBILITY</p>
 <p>ANSI A2 16-330 - Double-dipped coating resists oil penetration</p>	 <p>ANSI A2 16-334 - Salt & pepper liner and dark coating hides dirt - Tough wearing glove, ideal for light assembly and inspection</p>	 <p>ANSI A2 16-343LG - Hi-Vis liner for added visibility - Double-dipped coating resists oil penetration</p> <p>HI-VISIBILITY</p>	 <p>ANSI A2 16-343OR - Hi-Vis liner for added visibility - Double-dipped coating resists oil penetration</p> <p>HI-VISIBILITY</p>
 <p>ANSI A2 16-355 - Extended coating coverage to knuckle for heavy-duty jobs - Dark liner and coating hides dirt</p>	 <p>ANSI A2 19-D350 - Light, cool, flexible feel - Affordable value</p>	 <p>ANSI A2 713KSNF - Resistant to light heat and spark - Thin flexible coating ideal for applications that require hand dexterity</p> <p>HEAT RESISTANT</p>	 <p>ANSI A2 HVG713SSN - Reinforced wear points for added durability - Hi-vis liner for added visibility - Strong wearing, comfortable fit</p> <p>TOUCHSCREEN COMPATIBLE</p>

STYLE	ANSI CUT	EN388	ANSI/ISEA 138	COATING	COATING COVERAGE	COATING COLOR	LINER	LINER COLOR	GAUGE	SIZES	PROP 65
09-K1400	A2	2342BX	-	Nitrile Smooth	Palm & Fingers	Black	Kevlar®	Yellow	10	XS-XL	-
09-K1450	A2	3221BX	-	Nitrile Smooth	Palm & Fingers	Black	Kevlar®	Yellow	15	XS-3XL	-
09-K1650	A2	4342BX	-	Nitrile MicroFinish®	Palm & Fingers	Black	Kevlar®	Yellow	13	S-2XL	-
09-K1660	A2	4343BX	-	Nitrile MicroSurface	Palm & Fingers	Black	Kevlar®	Yellow	13	S-2XL	-
16-323	A2	4332BX	-	Nitrile Foam	Palm & Fingers	Gray	PolyKor®	Hi-Vis Yellow	15	XS-3XL	-
16-330	A2	4342BX	-	Nitrile MicroSurface	Palm & Fingers	Black	PolyKor®	Blue	13	XS-2XL	-
16-334	A2	4343BX	-	Nitrile Foam	Palm & Fingers	Black	PolyKor®	Salt & Pepper	13	XS-2XL	-
16-343LG	A2	4344BX	-	Nitrile MicroSurface	Palm & Fingers	Black	HPPE Blend	Hi-Vis Yellow	13	XS-2XL	-
16-343OR	A2	4344BX	-	Nitrile MicroSurface	Palm & Fingers	Black	PolyKor®	Hi-Vis Orange	13	XS-2XL	-
16-355	A2	4343BX	-	Nitrile Foam	Palm, Fingers & Knuckles	Black	PolyKor®	Salt & Pepper	13	XS-2XL	-
19-D350	A2	4542BX	-	Nitrile Foam	Palm & Fingers	Gray	Dyneema® Diamond	Salt & Pepper	13	S-XL	-
19-D355	A3	4443CX	-	Nitrile Foam	Palm, Fingers & Knuckles	Black	Dyneema® Diamond	Salt & Pepper	13	S-XL	-
505	A3	4542	-	Nitrile Smooth	Palm & Fingers	Black	ATA® Blended	Yellow	13	XS-2XL	-
713KSNF	A2	4343BX	-	Nitrile Foam	Palm & Fingers	Black	Kevlar®	Yellow	13	XS-2XL	-
730TBN	A3	4543CX	-	Nitrile Smooth	Palm & Fingers	Black	HPPE Blend	Gray	13	S-2XL	-
1CF7006FTPR	A3	-	-	Nitrile Sandy	Palm & Fingers	Black	HPPE Blend	Gray	13	S-2XL	⚠️ C
HVG713SSN	A2	4X42BX	-	Nitrile Sandy	Palm & Fingers	Black	HPPE Blend	Hi-Vis Green	13	S-2XL	-

C = ⚠️ **WARNING:** Cancer - www.P65Warnings.ca.gov

R = ⚠️ **WARNING:** Reproductive Harm - www.P65Warnings.ca.gov

C&R = ⚠️ **WARNING:** Cancer and Reproductive Harm - www.P65Warnings.ca.gov



Scan it

Nitrile MicroFoam



GOOD GRIP, DURABLE COATING
PREMIUM PERFORMANCE

Handling, Assembly and Sorting of Small to Medium Parts / Finishing and Parts Inspection / Mechanical Equipment Maintenance and Repair



▲ 19-D470

ENHANCED PROTECTION

▲ 19-D475

ANSI
A4

MAXICUT® & MAXICUT® DRY

- Excellent dry grip
- Good dexterity and tactility
- Patented Nitrile MicroFoam coating offers 360° breathability



▲ 44-3745

SILICONE FREE



▲ 44-3445

MICRO DOT PALM



▲ 44-6745

DYNEEMA® DIAMOND TECHNOLOGY

ANSI
A3

MAXICUT® ULTRA DT™ & MAXICUT® ULTRA

- Secure dry and light oily grip
- Thumb reinforcement for added durability
- Patented Nitrile MicroFoam coating offers 360° breathability



▲ 44-504

ENHANCED PROTECTION

▲ 44-505

ANSI
A3

MAXICUT® OIL

- Secure wet and oily grip
- Reinforced thumb for added durability
- Good puncture resistance



▲ 44-304



▲ 44-305

ENHANCED PROTECTION

ANSI
A2

MAXICUT® OIL

- Secure wet and oily grip
- Lightweight and durable
- Reinforced thumb for added durability



▲ 18-570

ENHANCED PROTECTION

▲ 18-575

ANSI
A2

MAXICUT®

- Secure dry grip
- Good dexterity and tactility
- Reinforced thumb for added durability
- Good puncture resistance
- Patented Nitrile MicroFoam coating offers 360° breathability and compatibility with light oils

Breathable cut resistance
and premium performance

STYLE	ANSI CUT	EN388	ANSI/ISEA 138	COATING	COATING COVERAGE	COATING COLOR	LINER	LINER COLOR	GAUGE	SIZES	PROP 65
19-D470	A4	4443DX	-	Nitrile MicroFoam	Palm & Fingers	Gray	MaxiCut®	Gray	13	XS-2XL	-
19-D475	A4	4443DX	-	Nitrile MicroFoam	Palm, Fingers & Knuckles	Gray	MaxiCut® Dry	Gray	13	XS-2XL	-
44-3445	A3	4542CX	-	Nitrile MicroFoam w/ Micro Dots	Palm & Fingers	Black	MaxiCut® Ultra DT™	Blue	15	XS-2XL	-
44-3455	A3	4542CX	-	Nitrile MicroFoam w/ Micro Dots	Palm & Fingers	Black	MaxiCut® Ultra DT™	Blue	15	XS-2XL	-
44-3745	A3	4542CX	-	Nitrile MicroFoam	Palm & Fingers	Black	MaxiCut® Ultra™	Blue	15	XS-3XL	-
44-3745V*	A3	4542CX	-	Nitrile MicroFoam	Palm & Fingers	Black	MaxiCut® Ultra™	Blue	15	XS-2XL	-
44-3745T**	A3	4542CX	-	Nitrile MicroFoam	Palm & Fingers	Black	MaxiCut® Ultra™	Blue	15	M-XL	-
44-3755	A3	4542CX	-	Nitrile MicroFoam	Palm & Fingers	Black	MaxiCut® Ultra™	Blue	15	XS-3XL	-
44-504	A3	4442CX	-	Nitrile MicroFoam	Palm & Fingers	Black	MaxiCut® Oil™	Blue	15	XS-2XL	-
44-505	A3	4442CX	-	Nitrile MicroFoam	Palm, Fingers & Knuckles	Black	MaxiCut® Oil™	Blue	15	XS-2XL	-
44-6745	A3	4X43CX	-	Nitrile MicroFoam	Palm & Fingers	Black	MaxiCut® Ultra™	Light Blue	15	S-2XL	-
18-570	A2	4331BX	-	Nitrile MicroFoam	Palm & Fingers	Gray	MaxiCut®	Green	15	XS-3XL	-
18-575	A2	4331BX	-	Nitrile MicroFoam	Palm, Fingers & Knuckles	Gray	MaxiCut®	Green	15	XS-2XL	-
44-304	A2	4341BX	-	Nitrile MicroFoam	Palm & Fingers	Black	MaxiCut® Oil™	Green	15	XS-2XL	-
44-305	A2	4341BX	-	Nitrile MicroFoam	Palm, Fingers & Knuckles	Black	MaxiCut® Oil™	Green	15	XS-2XL	-

* Vend version available

** Tagged version available



Nitrile MicroFoam



MAXIMUM DEXTERITY, BREATHABILITY,
COMFORT & DURABILITY

Handling, Assembly and Sorting /
General Industrial Applications /
Precision Construction Jobs



Scan it



▲ 34-8743

▲ 34-8443

▲ 34-1743

▲ 34-6743

ANSI
A2

MAXIFLEX® CUT™

- Good dry and light oily grip
- High dexterity and tactility
- Patented Nitrile MicroFoam coating offers 360° breathability
- Made with component materials that comply with federal regulations for food contact 21 CFR, 170-199

STYLE	ANSI CUT	EN388	ANSI/ISEA 138	COATING	COATING COVERAGE	COATING COLOR	LINER	LINER COLOR	GAUGE	SIZES	PROP 65
34-1743	A4	4331DX	-	Nitrile MicroFoam	Palm & Fingers	Black	MaxiFlex® Cut™	Black	15	XS-2XL	-
34-6743	A2	4X32BX	-	Nitrile MicroFoam	Palm & Fingers	Black	MaxiFlex® Cut™	Green	15	S-2XL	-
34-8443	A2	4331BX	-	Nitrile MicroFoam w/ Micro Dots	Palm & Fingers	Black	MaxiFlex® Cut™	Green	15	XS-2XL	-
34-8443V	A2	4331BX	-	Nitrile MicroFoam w/ Micro Dots	Palm & Fingers	Black	MaxiFlex® Cut™	Green	15	XS-2XL	-
34-8443T**	A2	4331BX	-	Nitrile MicroFoam	Palm & Fingers	Black	MaxiFlex® Cut™	Green	15	XS-2XL	-
34-8453	A2	4331BX	-	Nitrile MicroFoam w/ Micro Dots	Palm & Fingers	Black	MaxiFlex® Cut™	Green	15	XS-2XL	-
34-8743	A2	4331BX	-	Nitrile MicroFoam	Palm & Fingers	Black	MaxiFlex® Cut™	Green	15	XS-3XL	-
34-8743FY	A2	4331BX	-	Nitrile MicroFoam	Palm & Fingers	Hi-Vis Yellow	MaxiFlex® Cut™	Hi-Vis Yellow	15	XS-2XL	-
34-8743V	A2	4331BX	-	Nitrile MicroFoam	Palm & Fingers	Black	MaxiFlex® Cut™	Green	15	XS-3XL	-
34-8753	A2	4331BX	-	Nitrile MicroFoam	Palm, Fingers & Knuckles	Black	MaxiFlex® Cut™	Green	15	XS-3XL	-

* Vend version available

** Tagged version available



Scan it



Latex



SECURE GRIP WET OR DRY,
TEAR & PUNCTURE RESISTANT

Handling and Cleanup of Heavy to Medium Abrasive Parts and Materials
Demolition / Masonry and Tile / Steel Rod and Metal Fastening and Assembly



ANSI
A5

41-8035
-Single-layer construction provides excellent dexterity
-Full hand coverage keeps hands warm and dry

DOUBLE-DIPPED



ANSI
A4

09-K1300
-Resistant to light heat and spark
-Latex crinkle grip offers high abrasion and puncture resistance

TOP SELLER



ANSI
A4

09-K1700
-Resistant to light heat and spark
-MicroFinish® coating is ideal for applications that require a secure wet grip

LIGHT HEAT RESISTANCE



ANSI
A4

19-D313
-Safe for indirect food contact
-Light, cool, flexible feel
-Tough wearing glove for masonry and stonework applications

LIGHT HEAT RESISTANCE



ANSI
A4

41-8014
-Insulated hand protection for cold weather applications
-Single-layer PolyKor® acrylic layer provides excellent dexterity

NEW



ANSI
A3

09-K1310
-Resistant to light heat and spark
-Ideal for applications that require secure dry grip

LIGHT HEAT RESISTANCE



ANSI
A3

09-K1320
-Resistant to light heat and spark
-Ideal for applications that require secure dry grip

NEW



ANSI
A3

09-K1350
-Resistant to light heat and spark
-Insulated hand protection for cold weather applications

INSULATED



ANSI
A3

09-K1444
-Resistant to light heat and spark
-MicroFinish® coating is ideal for applications that require a secure wet grip

LIGHT HEAT RESISTANCE



ANSI
A3

16-815
-Salt & pepper liner and coating hides dirt
-MicroFinish® coating is ideal for applications that require a secure wet grip



ANSI
A3

16-820
-Insulated hand protection for cold weather applications
-Extended coating coverage to knuckle for heavy-duty jobs

TOP SELLER



ANSI
A2

16-813
-General use glove with light cut resistance
-Yellow coating provides added visibility

STYLE	ANSI CUT	EN388	ANSI/ISEA 138	COATING	COATING COVERAGE	COATING COLOR	LINER	LINER COLOR	GAUGE	SIZES	PROP 65
09-K1300	A4	3544DX	-	Latex Crinkle	Palm & Fingers	Blue	Kevlar®	Yellow	7	S-2XL	-
09-K1310	A3	2444CX	-	Latex Crinkle	Palm & Fingers	Blue	Kevlar®	Yellow	10	S-XL	-
09-K1310V*	A3	2444CX	-	Latex Crinkle	Palm & Fingers	Blue	Kevlar®	Yellow	10	S-XL	-
09-K1320	A3	3K43CX	-	Latex Crinkle	Palm & Fingers	Blue	Aramid	Yellow	10	XS-2XL	-
09-K1350	A3	2342CX	-	Latex MicroFinish®	Palm & Fingers	Brown	Kevlar® Insulated	Yellow	10	S-2XL	-
09-K1444	A3	2444CX	-	Latex MicroFinish®	Palm & Fingers	Blue	Kevlar®	Yellow	10	S-2XL	-
09-K1700	A4	3544DX	-	Latex MicroFinish®	Palm & Fingers	Blue	Kevlar®	Yellow	10	S-2XL	-
16-813	A2	3343BX	-	Latex Crinkle	Palm & Fingers	Yellow	PolyKor®	White	13	XS-2XL	-
16-815	A3	3543CX	-	Latex MicroSurface	Palm & Fingers	Black	PolyKor®	Salt & Pepper	13	S-2XL	-
16-820	A3	3K43CX	-	Latex MicroSurface	Palm, Fingers & Knuckles	Black	PolyKor®	Salt & Pepper	13	S-2XL	-
19-D313	A4	3544DX	-	Latex Crinkle	Palm & Fingers	Blue	Dyneema® Diamond	White	13	S-XL	-
41-8014	A4	3K42D	-	Latex MicroSurface	Palm & Fingers	Black	PolyKor®	Blue & Black	10	S-2XL	-
41-8035	A5	3K42E	-	Latex MicroSurface	Full Hand	Black	PolyKor®	Gray	10	S-2XL	-

*Vend version available

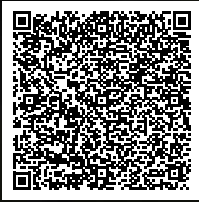

Scan it



Polyurethane



THIN COATING, GOOD GRIP FOR HIGH DEXTERITY HANDLING

Handling, Assembly and Sorting of Small to Medium Parts and Materials
Shipping, Receiving and Packaging / MRO Applications



ANSI A7

16-573

- Lightweight coating and liner provides dexterity and tactile sensitivity
- Ideal for medium duty applications that require high dexterity and tactile sensitivity

NEW

ANSI A5

16-645LG

- Hi-vis liner for added visibility
- Optimal level of flexibility and cut protection

HI-VISIBILITY

ANSI A5

16-665

- Aramid blended shell provides light heat resistance
- Ideal for handling hot parts in machining and molding operations

ANSI A5

713CFHGWU

- Strong wearing, comfortable fit
- Optimal level of flexibility and cut protection

ANSI A5

556

- Ultra-lightweight 18-gauge liner delivers outstanding dexterity and tactile sensitivity
- Touchscreen compatible
- Reinforced thumb crotch

ANSI A4

16-560

- Best selling G-Tek® medium cut glove
- Flexible liner shell with thin coating for precision work

BEST SELLER

16-564
Industry grade

ANSI A4

16-561

- Thin flexible and strong
- Ideal for medium duty applications that require high dexterity and tactile sensitivity

NEW

ANSI A4

19-D322

- Made from bio-based fibers to provide a sustainable solution
- Light, cool, flexible feel
- Ideal for general parts inspection and quality control

ECO SERIES BIO-BASED FIBERS

MADE WITH BIO-BASED TECHNOLOGY

ANSI A4

19-D330

- Light, cool, flexible feel
- Safe for indirect food contact
- Ideal for sharp parts inspection and quality control

ANSI A3

09-K1150

- Resistant to light heat and spark
- Ideal for machining, deburring and polishing

NEW

ANSI A3

16-530

- Thin flexible and strong
- Ideal for medium duty applications that require high dexterity and tactile sensitivity

16-533
Value priced alternative

ANSI A3

19-D310

- Light, cool, flexible feel
- Ideal for general parts inspection and quality control

STYLE	ANSI CUT	EN388	ANSI/ISEA 138	COATING	COATING COVERAGE	COATING COLOR	LINER	LINER COLOR	GAUGE	SIZES	PROPERTIES
15-340	A4	4542DX	-	Polyurethane	Palm & Fingers	Black	Supreme®	Tan	13	XS-2XL	▲ C
16-530	A3	4X43CX	-	Polyurethane	Palm & Fingers	Gray	PolyKor®	Salt & Pepper	13	XS-2XL	▲ C
16-533	A3	4X41CX	-	Polyurethane	Palm & Fingers	Gray	PolyKor®	Salt & Pepper	13	S-2XL	▲ C
16-560	A4	4543DX	-	Polyurethane	Palm & Fingers	Gray	PolyKor®	Gray	13	XS-2XL	▲ C
16-564	A4	4X41DX	-	Polyurethane	Palm & Fingers	Gray	PolyKor®	Gray	13	XS-2XL	▲ C
16-645LG	A5	4X42EX	-	Polyurethane	Palm & Fingers	Gray	PolyKor®	Hi-Vis Yellow	13	XS-2XL	▲ C
16-665	A5	4X42EX	-	Polyurethane	Palm & Fingers	Black	PolyKor®	Green	13	S-2XL	▲ C
16-X540	A4	4542DX	-	Polyurethane	Palm & Fingers	Black	PolyKor® Xrystal™	Gray	13	XS-2XL	▲ C
19-D310	A3	4442CX	-	Polyurethane	Palm & Fingers	Gray	Dyneema® Diamond	White	13	XS-2XL	▲ C
19-D322	A4	4X42D	-	Polyurethane	Palm & Fingers	Gray	Dyneema® Diamond 2.0	White	13	XS-2XL	▲ C
19-D325	A3	4541CX	-	Polyurethane	Palm & Fingers	White	Dyneema® Diamond	White	13	XXS-2XL	▲ C
19-D330	A4	4542DX	-	Polyurethane	Palm & Fingers	Gray	Dyneema® Diamond	White	13	XS-3XL	▲ C
556	A5	4X31E	-	Polyurethane	Palm & Fingers	Black	PolyKor®	Gray	18	XS-2XL	▲ C
713CFHGWU	A5	4443EX	-	Polyurethane	Palm & Fingers	Gray	HPPE Blend	White	13	XXS-3XL	▲ C
09-K1150	A3	3X41CX	-	Polyurethane	Palm & Fingers	Gray	Aramid	Yellow	13	XS-2XL	▲ C
16-561	A4	4X43DX	-	Polyurethane	Palm & Fingers	Black	PolyKor®	Gray	13	XS-2XL	▲ C
16-573	A7	4X43FX	-	Polyurethane	Palm & Fingers	Gray	PolyKor® XT™	Gray	13	XS-2XL	▲ C

C = ▲ **WARNING:** Cancer - www.P65Warnings.ca.gov

R = ▲ **WARNING:** Reproductive Harm - www.P65Warnings.ca.gov

C&R = ▲ **WARNING:** Cancer and Reproductive Harm - www.P65Warnings.ca.gov



G-TEK® POLYURETHANE COATED SEAMLESS KNIT CUT RESISTANT GLOVES



ANSI **A3**
16-520HY
 - Optimal level of flexibility and protection
 - Color aids in hand-to-eye awareness ideal for moving assembly line

HI-VISIBILITY



ANSI **A3**
19-D325
 - Light, cool, flexible feel
 - Ideal for clean environment and inspection applications



ANSI **A3**
19-D326
 - Light, cool, flexible feel
 - Dark liner and coating hides dirt
 - Versatile glove for multi-purpose applications



ANSI **A3**
19-D327
 - Light, cool, flexible feel
 - Safe for indirect food contact
 - Versatile glove for multi-purpose applications
19-D360
 13 gauge



ANSI **A3**
730TGU
 - Strong wearing, comfortable fit
 - Reliable and versatile glove for multi-purpose applications



ANSI **A3** EN374-5
16-VRX380
 - Ultra-lightweight 18-gauge cut resistant liner delivers outstanding dexterity and tactile sensitivity
 - Machine washable up to 6 wash cycles without negatively impacting coating properties

TOUCHSCREEN COMPATIBLE



ANSI **A2**
09-K1250
 - Resistant to light heat and spark
 - Ideal for machining, deburring and polishing

LIGHT HEAT RESISTANCE



ANSI **A2**
16-150
 - Liner/coating hides dirt for longer wear
 - Reliable and versatile glove for multi-purpose applications



ANSI **A2**
16-D622
 - General use glove with light cut resistance
 - Comfortable wearing glove for multi-task operations

BEST SELLER



ANSI **A2**
16-322
 - Premium grade
 - Bright color helps in-hand visibility for handling small components



ANSI **A2**
19-D318
 - Lightweight coating and liner provides dexterity and tactile sensitivity
 - Cool wearing all-day comfort



ANSI **A2**
19-D324
 - Light, cool, flexible feel
 - Versatile glove for multi-purpose applications



ANSI **A2**
703COPB
 - HPPE shell is strong and durable without compromising dexterity
 - Hi-vis color aids in hand-to-eye awareness, ideal for directing the loading and unloading of parts and materials

HI-VISIBILITY



ANSI **A2**
720DGU
 - HPPE shell is strong and durable without compromising dexterity
 - General use glove with light cut resistance



ANSI **A3**
16-747
 - Flexible glove/liner coating provides excellent dexterity and tactile sensitivity
 - PVC coating ideal for working with adhesives

PVC FOAM



ANSI **A2**
41-7322
 - Comfortable double layered 13-gauge nylon shell with a 7-gauge acrylic terry liner
 - PVC foam is water-resistant and flexible in extremely cold conditions

NEW PVC FOAM

STYLE	ANSI CUT	EN388	EN374-5	COATING	COATING COVERAGE	COATING COLOR	LINER	LINER COLOR	GAUGE	SIZES	PROP 65
09-K1250	A2	4231BX	-	Polyurethane	Palm & Fingers	Gray	Kevlar®	Yellow	13	XS-2XL	▲ ^C
16-150	A2	4342BX	-	Polyurethane	Palm & Fingers	Gray	PolyKor®	Salt & Pepper	13	XXS-3XL	▲ ^C
16-322	A2	4342BX	-	Polyurethane	Palm & Fingers	Blue	PolyKor®	Blue	18	XXS-2XL	▲ ^C
16-520HY	A3	4542CX	-	Polyurethane	Palm & Fingers	Hi-Vis Yellow	PolyKor®	Hi-Vis Yellow	13	XS-2XL	▲ ^C
16-D622	A2	4342BX	-	Polyurethane	Palm & Fingers	Gray	PolyKor®	White	13	XS-2XL	▲ ^C
16-VRX380	A3	4X32C	Yes	Polyurethane	Full Hand	Black	PolyKor®	Black	18	XS-2XL	▲ ^C
19-D318	A2	3342BX	-	Polyurethane	Palm & Fingers	Black	Dyneema® Diamond	Blue	18	XS-2XL	▲ ^C
19-D324	A2	4542BX	-	Polyurethane	Palm & Fingers	Black	Dyneema® Diamond	White	13	XS-2XL	▲ ^C
19-D326	A3	4442CX	-	Polyurethane	Palm & Fingers	Black	Dyneema® Diamond	Gray	13	XS-2XL	▲ ^C
19-D327	A3	4542CX	-	Polyurethane	Palm & Fingers	Gray	Dyneema® Diamond	Gray	15	XS-2XL	▲ ^C
19-D360	A3	4442CX	-	Polyurethane	Palm & Fingers	Gray	Dyneema® Diamond	Gray	13	S-XL	▲ ^C
703COPB	A2	4343BX	-	Polyurethane	Palm & Fingers	Black	HPPE Blend	Hi-Vis Orange	10	S-2XL	▲ ^C
720DGU	A2	4342BX	-	Polyurethane	Palm & Fingers	Gray	HPPE Blend	Salt & Pepper	13	XXS-3XL	▲ ^C
720DWU	A2	4X42BX	-	Polyurethane	Palm & Fingers	White	HPPE Blend	White	13	S-2XL	▲ ^C
730TGU	A3	4542CX	-	Polyurethane	Palm & Fingers	Gray	HPPE Blend	Gray	13	XS-2XL	▲ ^C
PVC Gloves											
16-747	A3	3341CX	-	PVC Smooth	Palm & Fingers	Black	PolyKor®	Black	13	XS-2XL	-
41-7322	A2	4X41BX	-	PVC Foam	Palm, Fingers & Knuckles	Black	PolyKor®	Black	13	M-2XL	▲ ^C

▲^C = **WARNING:** Cancer - www.P65Warnings.ca.gov R = **WARNING:** Reproductive Harm - www.P65Warnings.ca.gov C&R = **WARNING:** Cancer and Reproductive Harm - www.P65Warnings.ca.gov



Scan it

COATED SEAMLESS KNIT CUT RESISTANT GLOVES

Quick Find Index

ENHANCED PERFORMANCE FEATURES



TOUCHSCREEN

With the rapid increase of technology in the workplace, especially in factories and manufacturing plants where cut-resistant work gloves are used, touchscreen compatibility has never been more important. Use this index to locate gloves that combine cut resistance and touchscreen compatibility for increased safety and efficiency.



SILICONE FREE

Silicone is an excellent lubricant and release agent frequently found in manufacturing. These same properties are a major concern in coating or bonding applications, such as automotive finishing. The slightest trace of silicone can result in adhesive failure, resulting in poor quality finishes that cost time and drain resources to repair. Use this index to locate gloves that required for silicone-free applications.



21 CFR

Cross-contamination of one item or surface onto another can cause serious illnesses or allergic reactions. Coated seamless knit gloves are ideal for indirect contact in food plants for MRO applications or sorting and packaging tasks where the contact is incidental, or when the contact is not purposeful or continuous. Use this index to locate gloves that are ideal for indirect food contact applications.



STYLE NUMBER	ANSI CUT	DESCRIPTION	COATING	TOUCHSCREEN COMPATIBLE	SILICONE FREE	21 CFR
555	A5	G-Tek® PolyKor®	Nitrile Foam	•		
556	A5	G-Tek® PolyKor®	Polyurethane	•		
09-K1218	A3	G-Tek® KEV™	NeoFoam™	•		
15-440	A4	G-Tek® Supreme	NeoFoam™	•	•	
16-150	A2	G-Tek® PolyKor®	Polyurethane		•	
16-278	A7	G-Tek® PolyKor® X7™	Nitrile MicroSurface	•		
16-320	A2	G-Tek® PolyKor® X7™	NeoFoam™	•	•	
16-323	A2	G-Tek® PolyKor®	Nitrile Foam		•	•
16-368	A3	G-Tek® PolyKor® X7™	NeoFoam™	•		
16-373	A7	G-Tek® PolyKor®	Nitrile Foam	•		
16-377	A7	G-Tek® PolyKor® X7™	NeoFoam™	•	•	•
16-378	A7	G-Tek® PolyKor® X7™	Nitrile Foam	•		
16-399	A9	G-Tek® PolyKor® X7™	NeoFoam™ MicroSurface	•		
16-560	A4	G-Tek® PolyKor®	Polyurethane		•	
16-561	A4	G-Tek® PolyKor®	Polyurethane	•		
16-573	A7	G-Tek® PolyKor®	Polyurethane	•		
16-813	A2	G-Tek® PolyKor®	Latex Crinkle			•
16-854	A4	G-Tek® PolyKor®	Nitrile Foam	•		
16-939	A4	G-Tek® PolyKor® X7™	Nitrile MicroSurface	•		
16-MP585	A5	G-Tek® PolyKor® X7™	NeoFoam™	•		
16-MP785	A7	G-Tek® PolyKor® X7™	NeoFoam™	•		
16-MP935	A9	G-Tek® PolyKor® X7™	NeoFoam™ MicroSurface	•		
16-VRX380	A3	G-Tek® PolyKor®	Polyurethane	•	•	
19-0313	A4	G-Tek® 3GX	Latex Crinkle			•
19-0334	A3	G-Tek® 3GX	Nitrile Foam			•
19-0340LG	A4	G-Tek® 3GX	Nitrile Foam			•
19-03400R	A4	G-Tek® 3GX	Nitrile Foam			•
19-0350	A2	G-Tek® 3GX	Nitrile Foam			•
19-0355	A3	G-Tek® 3GX	Nitrile Foam			•
34-1743	A4	MaxiFlex® Cut™	Nitrile MicroFoam	•	•	
34-6743	A2	MaxiFlex® Cut™	Nitrile MicroFoam		•	
34-8443	A2	MaxiFlex® Cut™	Nitrile MicroFoam	•		
34-8743	A2	MaxiFlex® Cut™	Nitrile MicroFoam	•		•
34-8743FY	A2	MaxiFlex® Cut™	Nitrile MicroFoam			•
44-3745	A3	MaxiCut® Ultra™	Nitrile MicroFoam	•	•	•
44-3755	A3	MaxiCut® Ultra™	Nitrile MicroFoam		•	
720D6U	A2	G-Tek® PolyKor®	Polyurethane		•	
HV6713SNF	A4	G-Tek® PolyKor®	Nitrile Sandy	•		
HV6713SNFPP	A4	G-Tek® PolyKor®	Nitrile Sandy	•		



Scan it

COATED SEAMLESS KNIT
CUT RESISTANT GLOVES

Vend-ready solutions

PACKAGED FOR VENDING MACHINES



FREQUENTLY USED
ITEMS



OPTIMALLY SIZED
FOR MOST MACHINES



BARCODED PACKAGING FOR
INVENTORY CONTROL

The most comprehensive line of vend packed gloves

IN STOCK VEND-READY SOLUTIONS

STYLE NUMBER	ANSI CUT	EK388	COATING	COATING COVERAGE	COATING COLOR	LINER MATERIAL	LINER COLOR	CONSTRUCTION	GAUGE	SIZE	PROP 65
09-K1250V	4231B	A2	Polyurethane	Palm & Fingers	Yellow	Dupont™ Kevlar™	Yellow	Coated Seamless Knit	13	S-2XL	⚠️ ^C
09-K1310V	2444C	A3	Latex Crinkle	Palm & Fingers	Blue	Dupont™ Kevlar™	Yellow	Coated Seamless Knit	10	S-2XL	
09-K1450V	3221B	A2	Nitrile Smooth	Palm & Fingers	Black	Dupont™ Kevlar™	Yellow	Coated Seamless Knit	15	XS-3XL	
09-K1660V	4343X	A2	Nitrile MicroSurface	Palm & Fingers	Black	Dupont™ Kevlar™	Yellow	Coated Seamless Knit	13	S-2XL	
16-150V	4342B	A2	Polyurethane	Palm & Fingers	Gray	PolyKor™	Gray	Coated Seamless Knit	13	2XS-3XL	⚠️ ^C
16-318V	4342B	A2	Polyurethane	Palm & Fingers	Blue	PolyKor™	Blue	Coated Seamless Knit	18	2XS-2XL	⚠️ ^C
16-530V	4X43C	A3	Polyurethane	Palm & Fingers	Gray	PolyKor™	Salt & Pepper	Coated Seamless Knit	13	XS-2XL	⚠️ ^C
16-560V	4543D	A4	Polyurethane	Palm & Fingers	Gray	PolyKor™	Salt & Pepper	Coated Seamless Knit	13	XS-2XL	⚠️ ^C
16-D622V	4342X	A2	Polyurethane	Palm & Fingers	Gray	PolyKor™	White	Coated Seamless Knit	13	2XS-3XL	⚠️ ^C
19-D322V	4542C	A3	Polyurethane	Palm & Fingers	Gray	Dyneema™ Diamond	White	Coated Seamless Knit	13	XS-2XL	⚠️ ^C
34-8443V	4331B	A2	Nitrile MicroFoam	Palm & Fingers with Dots	Black	MaxiFlex™ Cut™	Green	Coated Seamless Knit	15	XS-2XL	
34-8743V	4331B	A2	Nitrile MicroFoam	Palm & Fingers	Black	MaxiFlex™ Cut™	Green	Coated Seamless Knit	15	XS-3XL	
44-3745V	4542C	A3	Nitrile MicroFoam	Palm & Fingers	Black	MaxiFlex™ Ultra™	Blue	Coated Seamless Knit	15	XS-2XL	
720D6UV	4342B	A2	Polyurethane	Palm & Fingers	Gray	HPPE Blend	Salt & Pepper	Coated Seamless Knit	13	XS-3XL	⚠️ ^C
09-H550SLPV	4X43F	A9	Leather	Palm & Fingers	Gray	PolyKor™	Orange	Seamless Knit	-	S-2XL	

C= ⚠️ **WARNING:** Cancer - www.P65Warnings.ca.gov R= ⚠️ **WARNING:** Reproductive Harm - www.P65Warnings.ca.gov CR= ⚠️ **WARNING:** Cancer and Reproductive Harm - www.P65Warnings.ca.gov

SECTION:

Uncoated Knit Cut Resistant Gloves



THE #1 TRUSTED BRAND
FOR HIGH-RISK FOOD
PROCESSING WORKERS

Made in the USA, Claw Cover® seamless knit gloves are designed to provide high-level cut protection while complying with both U.S. and Canadian standards for food contact. Claw Cover® gloves are launderable and can be used for operations where direct, indirect and incidental contact with food may occur.



MADE IN AMERICA
UNCOATED GLOVES FOR
INDUSTRIAL WORKERS

Kut Gard® is the Made in America brand for factories and operations demanding the highest level of cut resistant gloves, sleeves and garments. Proprietary engineered yarns and the ability to configure custom solutions make Kut Gard® the brand of choice for safety managers.

YARN TECHNOLOGIES

DYNEEMA®

Dyneema® is 15 times stronger than steel on a weight-for-weight basis! It's a high performance polyethylene (HPPE) fiber made from ultra high molecular weight polyethylene (UHMWPE). Dyneema® fiber is much thinner and more flexible than traditional materials, such as leather and cotton, while offering higher protection.

PolyKor®

Products constructed with PolyKor® engineered yarn are suitable to protect against mechanical hazards in the toughest environments. PolyKor® products are designed for different protection levels, up to the highest levels, while maintaining an unprecedented level of comfort.



CUTTING



CHOPPING



TRIMMING



FILETING



CUTS AND
SNAGS



GLASS
HANDLING

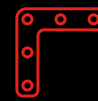

METAL
HANDLING



SHARP PARTS
ASSEMBLY



HEAT
RESISTANCE



CUTS AND
SNAGS

FIBER TECHNOLOGIES

KEVLAR®

Kevlar® is light, comfortable and provides enduring protection against heat, cuts, lacerations and abrasions. Protective gloves and sleeves bearing this brand name provide assurance of compliance with strict performance and quality standards and are produced only by Kevlar® licensed manufacturers.

ACP™ AND ATA®

Proprietary ACP™ and ATA® technologies raise the standards for performance knit products, offering an increase in overall performance and value compared to traditional Aramid products. ACP™ and ATA® provide excellent abrasion and cut resistance for a lower cost per use. Gloves and sleeves featuring ACP™ and ATA® technology are 100% silicone-free.

Antimicrobial treatment used on glove fibers/yarns help to inhibit bacteria, mold and mildew from developing in the presence of sweat and moisture, thereby improving comfort and extending the life of the sleeve.

Products referenced as "Compliant with FDA 21 CFR 177.2800" refer specifically to PART 177 — INDIRECT FOOD ADDITIVES: POLYMERS Sec. 177.2800 Textiles and textile fibers. Textiles and textile fibers may safely be used as articles or components of articles intended for use in producing, manufacturing, packing, processing, preparing, treating, packaging, transporting, or holding food.



CLAW COVER® HPPE
SEAMLESS KNIT CUT RESISTANT GLOVES



Scan it



HPPE

IDEAL FOR
FOOD PROCESSING WORKERS

Cutting / Chopping / Trimming / Filleting



HIGHEST RISK

ANSI
A9

CC-D3

- Ideal for applications where extremely sharp cutting instruments are used
- ATA® fiber patch reinforces highest cut risk areas



ANSI
A7

13-131

- Lightweight cut resistant glove with antimicrobial treatment
- Compliant with FDA 21 CFR 1772800 and approved for direct food contact



ANSI
A7

13-231

- Lightweight cut resistant glove with antimicrobial treatment
- Compliant with FDA 21 CFR 1772800 and approved for direct food contact



AVAILABLE WITH EXTENDED CUFF

ANSI
A7

10-C6GY

- Highly durable 10 gauge cut resistant glove ideal for food processing
- Compliant with FDA 21 CFR 1772800 and approved for direct food contact

Available with extended cuff:
10-C6YEC



MORE COMFORT

ANSI
A7

10-C5HVOCMX

- Highly durable 10 gauge cut resistant glove ideal for food processing
- Sta-COOL™ plating is cool against the skin

Available in gray:
10-C5GYCMX



ANSI
A6

10-121

- Highly durable 10 gauge cut resistant glove ideal for food processing
- Compliant with FDA 21 CFR 1772800 and approved for direct food contact



ANSI
A6

7-221

- Highly durable 7 gauge cut resistant glove ideal for food processing
- Compliant with FDA 21 CFR 1772800 and approved for direct food contact



ANSI
A5

13-121

- Lightweight cut resistant glove with antimicrobial treatment
- Compliant with FDA 21 CFR 1772800 and approved for direct food contact



ANSI
A5

13-221

- Lightweight cut resistant glove with antimicrobial treatment
- Compliant with FDA 21 CFR 1772800 and approved for direct food contact



ANSI
A3

13-111

- Lightweight cut resistant glove with antimicrobial treatment
- Compliant with FDA 21 CFR 1772800 and approved for direct food contact

MADE IN AMERICA
Cut Protection for
Food Industry Workers™

Claw Cover® with HPPE Technology

STYLE	ANSI CUT	21 CFR	MATERIAL	COLOR	CONSTRUCTION	GAUGE	WEIGHT	GRIP	SIZES	PROP 65
10-121	A6	Yes	Claw Cover® made with HPPE	Gray	Seamless Knit	10	Medium Weight	Uncoated	S-2XL	-
13-111	A3	Yes	Claw Cover® made with HPPE	Gray	Seamless Knit	13	Lightweight	Uncoated	XS-XL	-
13-121	A5	Yes	Claw Cover® made with HPPE	Gray	Seamless Knit	13	Lightweight	Uncoated	XS-2XL	-
13-131	A7	Yes	Claw Cover® made with HPPE	Gray	Seamless Knit	13	Lightweight	Uncoated	XS-2XL	-
13-221	A5	Yes	Claw Cover® made with HPPE	White	Seamless Knit	13	Lightweight	Uncoated	S-XL	-
13-231	A7	Yes	Claw Cover® made with HPPE	White	Seamless Knit	13	Lightweight	Uncoated	S-XL	-
7-221	A6	Yes	Claw Cover® made with HPPE	White	Seamless Knit	7	Heavyweight	Uncoated	XS-2XL	-
10-C6GYEC	A7	Yes	Claw Cover® made with HPPE	Gray	Seamless Knit	10	Medium Weight	Uncoated	S-XL	-
10-C6GY	A7	Yes	Claw Cover® made with HPPE	Gray	Seamless Knit	10	Medium Weight	Uncoated	S-2XL	-
10-C5HVOCMX	A7	Yes	Claw Cover® made with HPPE & Sta-COOL® Plating	Hi-Vis Orange	Seamless Knit	10	Medium Weight	Uncoated	S-3XL	-
10-C10GYCMX	A7	Yes	Claw Cover® made with HPPE & Sta-COOL® Plating	Gray	Seamless Knit	10	Medium Weight	Uncoated	XS-4XL	-
CC-D3	A9	Yes	Claw Cover® made with HPPE & ATA® Fiber Patch	Gray	Seamless Knit	7	Heavyweight	Uncoated	XS-XL	-

C= ⚠️ WARNING: Cancer - www.P65Warnings.ca.gov R= ⚠️ WARNING: Reproductive Harm - www.P65Warnings.ca.gov CR= ⚠️ WARNING: Cancer and Reproductive Harm - www.P65Warnings.ca.gov



Scan it



Polykor®

AFFORDABLE PROTECTION
OPTIMIZED FOR FOOD APPLICATIONS

Cutting / Chopping / Trimming / Filleting



ANSI
A9

22-600

- Heavy-duty cut resistant glove with antimicrobial treatment
- Complies with FDA food handling requirements 21 CFR, Part 177

HEAVY DUTY & HIGH CUT



ANSI
A9

22-600BK

- Heavy-duty cut resistant glove with antimicrobial treatment
- Complies with FDA food handling requirements 21 CFR, Part 177



ANSI
A9

22-601

- Siligrip coated palm provides a secure wet and dry grip
- Stands up to light solvents, proteins, fats and blood

EXTRA GRIP



ANSI
A9

22-615

- Siligrip coated palm provides a secure wet and dry grip
- Stands up to light solvents, proteins, fats and blood



ANSI
A7

22-650

- Highly durable 7 gauge cut resistant glove ideal for food processing
- Complies with FDA food handling requirements 21 CFR, Part 177

HIGH DURABILITY



ANSI
A6

22-720

- Medium weight cut resistant glove with antimicrobial treatment
- Complies with FDA food handling requirements 21 CFR, Part 177



ANSI
A5

14-ASP700

- Medium weight cut resistant glove ideal for food processing
- Complies with FDA food handling requirements 21 CFR, Part 177



ANSI
A4

22-730

- Lightweight cut resistant glove ideal for food processing
- Complies with FDA food handling requirements 21 CFR, Part 177

ENGINEERED PROTECTION FOR FOOD APPLICATIONS

Claw Cover® with PolyKor® Technology

STYLE	ANSI CUT	21 CFR	MATERIAL	COLOR	CONSTRUCTION	GAUGE	WEIGHT	GRIP	SIZES	PROP 65
14-ASP700	A5	Yes	Claw Cover® made with PolyKor®	Salt & Pepper	Seamless Knit	7	Heavyweight	Uncoated	S-XL	-
22-600	A9	Yes	Claw Cover® made with PolyKor®	White	Seamless Knit	7	Heavyweight	Uncoated	XS-XL	-
22-600BK	A9	Yes	Claw Cover® made with PolyKor®	Black	Seamless Knit	7	Heavyweight	Uncoated	S-L	-
22-601	A9	Yes	Claw Cover® made with PolyKor®	White	Seamless Knit, Hand Specific	7	Heavyweight	Silicone	S-XL	-
22-615	A9	Yes	Claw Cover® made with PolyKor®	White	Seamless Knit, Half Finger, Hand Specific	7	Heavyweight	Silicone	S-XL	-
22-650	A7	Yes	Claw Cover® made with PolyKor®	Blue	Seamless Knit	7	Heavyweight	Uncoated	XS-XL	-
22-720	A6	Yes	Claw Cover® made with PolyKor®	White	Seamless Knit	10	Medium Weight	Uncoated	XS-XL	-
22-730	A4	Yes	Claw Cover® made with PolyKor®	White	Seamless Knit	13	Lightweight	Uncoated	XS-2XL	-

C = **WARNING:** Cancer - www.P65Warnings.ca.gov

R = **WARNING:** Reproductive Harm - www.P65Warnings.ca.gov

C&R = **WARNING:** Cancer and Reproductive Harm - www.P65Warnings.ca.gov



CLAW COVER® DYNEEMA™
SEAMLESS KNIT CUT RESISTANT GLOVES



Scan it



Dyneema

UNPARALLELED COMFORT, COOLNESS AND PROTECTION PLUS MULTI-COLOR OFFERING

Filleting / Trimming / Chopping / Cutting



ANSI A9

22-780

- Ideal for applications where extremely sharp cutting instruments are used
- Complies with FDA food handling requirements 21 CFR, Part 177



ANSI A7

22-760G

- Highly durable 10 gauge cut resistant glove ideal for food processing
- Complies with FDA food handling requirements 21 CFR, Part 177

THIN + HIGH CUT SCORE



ANSI A7

22-901

- Secure grip in wet and dry environments
- UV stable, will not degrade over time
- Complies with FDA food handling requirements 21 CFR, Part 177



ANSI A5

22-765OR

- Heavyweight protection with the comfortable fit of a lightweight glove
- Complies with FDA food handling requirements 21 CFR, Part 177



ANSI A4

17-DA700

- Heavyweight protection with resistance to light heat and spark
- Superior chemical resistance to acids, alkali and organic solvents

ANSI A7

HIGH CUT GLOVES

- Excellent cut resistance protects against cuts and scrapes
- Antimicrobial fiber has been shown to inhibit the growth of microorganisms
- Unparalleled comfort, fit and coolness



ANSI A7

HIGH CUT SLEEVES

- Excellent cut resistance protects against cuts and scrapes
- Antimicrobial fiber has been shown to inhibit the growth of microorganisms
- Unparalleled comfort, fit and coolness



MATCHING CUT RESISTANT SLEEVES

See arm protection section

Claw Cover® with Dyneema® Technology

STYLE	ANSI CUT	21 CFR	MATERIAL	COLOR	CONSTRUCTION	GAUGE	WEIGHT	GRIP	SIZES	PROP 65
18-SD385	A6	Yes	Claw Cover® made with Dyneema™	Gray	Seamless Knit, Extended Cuff	7	Heavyweight	PVC	L	⚠️ C
22-750	A5	Yes	Claw Cover® made with Dyneema™	White	Seamless Knit	13	Lightweight	Uncoated	XS-XL	-
22-750G	A5	Yes	Claw Cover® made with Dyneema™	Gray	Seamless Knit	13	Lightweight	Uncoated	XS-XL	-
22-750NP	A5	Yes	Claw Cover® made with Dyneema™	Neon Pink	Seamless Knit	13	Lightweight	Uncoated	XS-XL	-
22-751	A5	Yes	Claw Cover® made with Dyneema™	White	Seamless Knit, Hand Specific	13	Lightweight	Silicone	S-XL	-
22-754	A4	Yes	Claw Cover® made with Dyneema™	Gray	Seamless Knit	13	Lightweight	Uncoated	S-XL	-
22-760	A7	Yes	Claw Cover® made with Dyneema™	White	Seamless Knit	10	Medium Weight	Uncoated	XS-XL	-
22-760BB	A7	Yes	Claw Cover® made with Dyneema™	Blue	Seamless Knit	10	Medium Weight	Uncoated	L	-
22-760BG	A7	Yes	Claw Cover® made with Dyneema™	Lime	Seamless Knit	10	Medium Weight	Uncoated	L	-
22-760G	A7	Yes	Claw Cover® made with Dyneema™	Gray	Seamless Knit	10	Medium Weight	Uncoated	XS-XL	-
22-760GRN	A7	Yes	Claw Cover® made with Dyneema™	Green	Seamless Knit	10	Medium Weight	Uncoated	L	-
22-760NP	A7	Yes	Claw Cover® made with Dyneema™	Pink	Seamless Knit	10	Medium Weight	Uncoated	M-L	-
22-760OR	A7	Yes	Claw Cover® made with Dyneema™	Orange	Seamless Knit	10	Medium Weight	Uncoated	XS-2XL	-
22-761	A7	Yes	Claw Cover® made with Dyneema™	Gray	Seamless Knit, Hand Specific	10	Medium Weight	Silicone	S-XL	-
22-765OR	A5	Yes	Claw Cover® made with Dyneema™	Orange	Seamless Knit	10	Medium Weight	Uncoated	XS-XL	-
22-770	A6	Yes	Claw Cover® made with Dyneema™	White	Seamless Knit	7	Heavyweight	Uncoated	XS-L	-
22-780	A9	Yes	Claw Cover® made with Dyneema™	White	Seamless Knit	7	Heavyweight	Uncoated	XS-XL	-
22-900	A7	Yes	Claw Cover® made with Dyneema™	Gray	Seamless Knit	7	Heavyweight	Uncoated	XS-XL	-
22-901	A7	Yes	Claw Cover® made with Dyneema™	Gray	Seamless Knit, Hand Specific	7	Heavyweight	Uncoated	S-XL	-

Claw Cover® with ACP™ Dyneema® Technology

17-DA700	A4	Yes	Claw Cover® made with ACP™ / Dyneema® Blend	Gray	Seamless Knit	7	Heavyweight	Uncoated	S-XL	-
17-DA752	A6	Yes	Claw Cover® made with ACP™ / Dyneema® Blend	Gray	Seamless Knit, Extended Cuff	10	Medium Weight	Silicone	XS-2XL	-

⚠️ C = **WARNING:** Cancer - www.P65Warnings.ca.gov ⚠️ R = **WARNING:** Reproductive Harm - www.P65Warnings.ca.gov ⚠️ CR = **WARNING:** Cancer and Reproductive Harm - www.P65Warnings.ca.gov



Scan it

**KUT
GARD®**

Kevlar® / Aramid

CUT RESISTANT WITH ADDED
LIGHT HEAT PROTECTION

Automotive / Glass Operations / Sheet Metal Fabrication /
Manufacturing of Appliances and Metal Enclosures



ANSI
A6

08-K385

- Slabbers glove with extended cuff
- Double-sided PVC dots provide enhanced grip and extra cut and abrasion resistance

SLABBERS WITH GRIP



ANSI
A6

07-K385

- Slabbers glove with extended cuff
- Heavy gauge glove offering increased durability



ANSI
A6

07-K390

- Highly durable heavy gauge cut resistant glove with reinforced thumb crotch
- Ideal for heavy-duty applications



ANSI
A4

M13TWPL

- Lightweight for dexterity and tactile sensitivity
- Lined with cotton for ultra soft comfort



ANSI
A3

08-K300PD

- Single-sided PVC dots provide a secure grip in wet and dry environments
- 100% Kevlar®

SECURE GRIP



ANSI
A3

08-K300PDD

- Double-sided PVC dots provide secure grip and abrasion resistance
- 100% Kevlar®

GRIP & ABRASION RESISTANT



ANSI
A2

08-K252

- Half finger for improved dexterity and tactile sensitivity
- Double-sided PVC dots provide secure grip and abrasion resistance

GRIP & ABRASION RESISTANT



ANSI
A3

MTW37PL

- Heavy gauge for increased durability and glove wear
- Lined with cotton for ultra soft comfort

SUPER COMFORT

Kut Gard® Kevlar®

STYLE	ANSI CUT	MATERIAL	COLOR	CONSTRUCTION	GAUGE	WEIGHT	GRIP	GRIP COVERAGE	SIZES	PROP 65
07-K200	A2	Kut Gard® made with Kevlar®	Yellow	Seamless Knit	13	Lightweight	Uncoated	-	XS-2XL	-
07-K259	A2	Kut Gard® made with Kevlar®	Yellow	Seamless Knit, Half Finger	7	Heavyweight	Uncoated	-	S-XL	-
07-K300	A3	Kut Gard® made with Kevlar®	Yellow	Seamless Knit	7	Heavyweight	Uncoated	-	XS-2XL	-
07-K320	A1	Kut Gard® made with Kevlar®	Yellow	Seamless Knit	7	Heavyweight	Uncoated	-	S-XL	-
07-K350	A3	Kut Gard® made with Kevlar®	Yellow	Seamless Knit	7	Heavyweight	Uncoated	-	XS-XL	-
07-K385	A6	Kut Gard® made with Kevlar®	Green	Seamless Knit, Extended Cuff	7	Heavyweight	Uncoated	-	M-XL	-
07-K390	A6	Kut Gard® made with Kevlar®	Green	Seamless Knit, Reinforced Thumb Crotch	7	Heavyweight	Uncoated	-	S-XL	-
07-KPB1200	A4	Kut Gard® PBI made with Kevlar®	Gold	Seamless Knit	13	Lightweight	Uncoated	-	XS-XL	-
08-K200PD	A2	Kut Gard® made with Kevlar®	Yellow	Seamless Knit	13	Lightweight	PVC	One Side	S-XL	▲ ^C
08-K200PDD	A2	Kut Gard® made with Kevlar®	Yellow	Seamless Knit	13	Lightweight	PVC	Double-Sided	S-XL	▲ ^C
08-K252	A2	Kut Gard® made with Kevlar®	Yellow	Seamless Knit	7	Heavyweight	PVC	Double-Sided	S-XL	▲ ^C
08-K259PDD	A2	Kut Gard® made with Kevlar®	Yellow	Seamless Knit, Half Finger	7	Heavyweight	PVC	Double-Sided	S-XL	▲ ^C
08-K300PD	A3	Kut Gard® made with Kevlar®	Yellow	Seamless Knit	7	Heavyweight	PVC	One Side	S-XL	▲ ^C
08-K300PDD	A3	Kut Gard® made with Kevlar®	Yellow	Seamless Knit	7	Heavyweight	PVC	Double-Sided	XS-XL	▲ ^C
08-K300PS	A2	Kut Gard® made with Kevlar®	Yellow	Seamless Knit	7	Heavyweight	PVC	One Side	S-XL	▲ ^C
08-K312	A2	Kut Gard® made with Kevlar®	Yellow	Seamless Knit	7	Heavyweight	PVC	Double-Sided	S-L	▲ ^C
08-K350PDD	A3	Kut Gard® made with Kevlar®	Yellow	Seamless Knit	7	Heavyweight	PVC	Double-Sided	S-XL	▲ ^C
08-K385	A6	Kut Gard® made with Kevlar®	Green	Seamless Knit, Extended Cuff	7	Heavyweight	PVC	Double-Sided	M-L	▲ ^C
09-K300LP	A4	Kut Gard® made with Kevlar®	Yellow	Leather Palm	7	Heavyweight	Leather Palm	-	S-XL	▲ ^{C&R}
35K	A2	Kut Gard® made with Kevlar®	Yellow	Seamless Knit	7	Heavyweight	Uncoated	-	M-XL	-
35KD	A3	Kut Gard® made with Kevlar®	Yellow	Seamless Knit	13	Lightweight	PVC	One Side	L	▲ ^C
35KDBS	A3	Kut Gard® made with Kevlar®	Yellow	Seamless Knit	7	Heavyweight	PVC	Double-Sided	M-XL	▲ ^C
35KDBSL	A3	Kut Gard® made with Kevlar®	Yellow	Seamless Knit	7	Heavyweight	PVC	Double-Sided	LADIES	▲ ^C
35KDBSY	A3	Kut Gard® made with Kevlar®	Yellow	Seamless Knit	7	Heavyweight	PVC	Double-Sided	XS	▲ ^C
35KDEBS	A2	Kut Gard® made with Kevlar®	Yellow	Seamless Knit	7	Heavyweight	PVC	Double-Sided	L	▲ ^C
35KDEBSL	A2	Kut Gard® made with Kevlar®	Yellow	Seamless Knit	7	Heavyweight	PVC	Double-Sided	LADIES	▲ ^C
35KE	A2	Kut Gard® made with Kevlar®	Yellow	Seamless Knit	7	Heavyweight	Uncoated	-	L	-
35KEL	A2	Kut Gard® made with Kevlar®	Yellow	Seamless Knit	7	Heavyweight	Uncoated	-	LADIES	-
Kut Gard® Aramid										
M13K	A2	Kut Gard® made with Aramid	Yellow	Seamless Knit	13	Lightweight	Uncoated	-	XS-XL	-
MTW13	A4	Kut Gard® made with Aramid	Yellow	Seamless Knit	13	Lightweight	Uncoated	-	S-2XL	-
MTW37PL	A3	Kut Gard® made with Aramid and Cotton Plating	Yellow	Seamless Knit	7	Heavyweight	Uncoated	-	S-XL	-
M13TWPL	A4	Kut Gard® made with Aramid and Cotton Plating	Yellow	Seamless Knit	13	Lightweight	Uncoated	-	M	-

▲ = WARNING: Cancer - www.P65Warnings.ca.gov

R = WARNING: Reproductive Harm - www.P65Warnings.ca.gov

C&R = WARNING: Cancer and Reproductive Harm - www.P65Warnings.ca.gov



KUT GARD® ACP™ / KEVLAR®
SEAMLESS KNIT CUT RESISTANT GLOVES



Scan it

**KUT
GARD®**

ACP™ / Kevlar®

LOW-COST ALTERNATIVE WITH CUT
AND LIGHT HEAT PROTECTION

Machine Operation / Metal Fabrication / Automotive / Plastic Molding



ANSI
A6

07-KA720

- Heavy gauge with high cut resistance for heavy-duty applications
- Polyester lining is ultra soft and very lightweight



ANSI
A6

07-KAB720

- Heavy gauge for increased durability and glove wear
- Dark color hides dirt
- 100% silicone-free

HIDES DIRT



ANSI
A5

07-KA700

- Heavy gauge for increased durability and glove wear
- Polyester lining is ultra soft and very lightweight

COMFORT LINING



ANSI
A4

07-KA710

- Medium gauge for improved dexterity
- 100% silicone-free



ANSI
A4

07-KA740

- Heavy gauge for increased durability and glove wear
- Polyester lining is ultra soft and very lightweight



ANSI
A4

07-KAB750

- Lightweight for dexterity and tactile sensitivity
- Dark color hides dirt
- 100% silicone-free



ANSI
A4

07-KAH760

- Lined with cotton for ultra soft comfort
- Heavy gauge for increased durability and glove wear



ANSI
A4

08-KAB750PD

- Lightweight gauge with single-sided PVC dotted palm provides a secure wet and dry grip and enhanced cut resistance

PVC DOTTED GRIP



ANSI
A4

08-KAB750PDD

- Heavy gauge with double-sided PVC dotted grip offers improved cut and abrasion resistance

GRIP & ABRASION RESISTANT



ANSI
A4

08-KA740PD

- Heavy gauge with single-sided PVC dotted palm provides a secure wet and dry grip and enhanced cut resistance



ANSI
A3

07-KA744

- Lined with cotton for ultra soft comfort
- 100% silicone-free



ANSI
A3

07-KA745

- Polyester lining is ultra soft and very lightweight
- 100% silicone-free

GREAT PROTECTION AND VALUE

ACP™ with Kevlar®

STYLE	ANSI CUT △	MATERIAL	COLOR	CONSTRUCTION	GAUGE	WEIGHT	GRIP	GRIP COVERAGE	SIZES	PROP 65
07-KA720	A6	Kut Gard® ACP™ with Kevlar®	Green	Seamless Knit	7	Heavyweight	Uncoated	-	S-XL	-
07-KAB720	A6	Kut Gard® ACP™ with Kevlar®	Gray	Seamless Knit	7	Heavyweight	Uncoated	-	S-XL	-
07-KA700	A5	Kut Gard® ACP™ with Kevlar®	Green	Seamless Knit	7	Heavyweight	Uncoated	-	S-XL	-
07-KA730	A5	Kut Gard® ACP™ with Kevlar®	Green	Seamless Knit	7	Heavyweight	Uncoated	-	S-XL	-
07-KA710	A4	Kut Gard® ACP™ with Kevlar®	Green	Seamless Knit	10	Medium Weight	Uncoated	-	S-XL	-
07-KA740	A4	Kut Gard® ACP™ with Kevlar®	Green	Seamless Knit	7	Heavyweight	Uncoated	-	S-XL	-
07-KAB750	A4	Kut Gard® ACP™ with Kevlar®	Gray	Seamless Knit	13	Lightweight	Uncoated	-	XS-XL	-
07-KAH760	A4	Kut Gard® ACP™ with Kevlar®	Yellow	Seamless Knit	7	Heavyweight	Uncoated	-	S-XL	-
08-KA740PD	A4	Kut Gard® ACP™ with Kevlar®	Green	Seamless Knit	7	Heavyweight	PVC	One Side	S-XL	⚠️ ^C
08-KAB750PD	A4	Kut Gard® ACP™ with Kevlar®	Gray	Seamless Knit	13	Lightweight	PVC	One Side	XS-XL	⚠️ ^C
08-KAB750PDD	A4	Kut Gard® ACP™ with Kevlar®	Gray	Seamless Knit	13	Lightweight	PVC	Double-Sided	XS,ML	⚠️ ^C
07-KA744	A3	Kut Gard® ACP™ with Kevlar®	Green	Seamless Knit	7	Heavyweight	Uncoated	-	XS-L	-
07-KA745	A3	Kut Gard® ACP™ with Kevlar®	Blue	Seamless Knit	7	Heavyweight	Uncoated	-	S-XL	-

C = ⚠️ **WARNING:** Cancer - www.P65Warnings.ca.gov R = ⚠️ **WARNING:** Reproductive Harm - www.P65Warnings.ca.gov CR = ⚠️ **WARNING:** Cancer and Reproductive Harm - www.P65Warnings.ca.gov



**KUT
GARD®**

ATA® Fiber Technology

BEST VALUE ALTERNATIVE WITH
HIGH CUT AND LIGHT HEAT PROTECTION

Machine Operations / Metal Fabrication / Automotive / Plastic Molding



Scan it



ANSI
A9

MATA503HA

- Heavy gauge Hide-Away™ shell with high cut resistance for heavy-duty applications
- Protects against contact heat injuries up to 392°F



ANSI
A9

MATA503

- Ideal for applications where extremely sharp cutting instruments are used
- Protects against contact heat injuries up to 392°F



ANSI
A8

MATA502HA

- Heavy gauge Hide-Away™ shell with high cut resistance for heavy-duty applications
- Protects against contact heat injuries up to 392°F



ANSI
A8

MATA502

- Heavy gauge with high cut resistance for heavy-duty applications
- Protects against contact heat injuries up to 284°F

ATA®

STYLE	ANSI CUT	ZI CFR	MATERIAL	COLOR	CONSTRUCTION	GAUGE	WEIGHT	GRIP	SIZES	PROP 65
MATA503HA	A9	-	Kut Gard® ATA® Hide-Away™ Technology with Aramid	Green	Seamless Knit	7	Heavyweight	Uncoated	S-2XL	-
MATA503	A9	-	Kut Gard® ATA® Technology with Aramid	Yellow	Seamless Knit	7	Heavyweight	Uncoated	S-2XL	-
MATA502HA	A8	-	Kut Gard® ATA® Hide-Away™ Technology with Aramid	Green	Seamless Knit	7	Heavyweight	Uncoated	S-2XL	-
MATA502	A8	-	Kut Gard® ATA® Technology with Aramid	Yellow	Seamless Knit	7	Heavyweight	Uncoated	S-2XL	-

C = **WARNING:** Cancer - www.P65Warnings.ca.gov

R = **WARNING:** Reproductive Harm - www.P65Warnings.ca.gov

C&R = **WARNING:** Cancer and Reproductive Harm - www.P65Warnings.ca.gov



LIGHTWEIGHT COMFORT PROTECTION AND PERFORMANCE



ANSI A7

MATA501HA
- Heavy gauge
- Hide-Away™ shell with high cut resistance for heavy-duty applications
- Protects against contact heat injuries up to 392°F

HEAT HANDLING



ANSI A7

MATA501
- Heavy gauge with high cut resistance for heavy-duty applications
- Protects against contact heat injuries up to 284°F



ANSI A7

MATA500ERTH
- Heavy gauge with high cut resistance for heavy-duty applications
- Reinforced thumb crotch adds durability in a high-wear area



ANSI A6

MATA500HA
- Heavy gauge
- Hide-Away™ shell with high cut resistance for heavy-duty applications
- Protects against contact heat injuries up to 392°F

HEAT HANDLING



ANSI A6

MATA500
- Heavy gauge with high cut resistance for heavy-duty applications
- Protects against contact heat injuries up to 392°F



ANSI A5

MATA110HA-OERTC2
- Highly durable heavy gauge cut resistant glove with reinforced thumb crotch
- Hide-Away™ fibers hide dirt and grime



ANSI A5

MATAKV/BKPL30
- Heavyweight protection with resistance to light heat and spark
- Protects against conductive heat injuries up to 500°F

HIGHER HEAT HANDLING



ANSI A4

MATA30HA
- Heavy gauge for increased durability and glove wear
- Hide-Away™ fibers hide dirt and grime



ANSI A4

MATA30PL
- Heavy gauge for increased durability and glove wear
- Lined with cotton for ultra soft comfort



ANSI A3

M530
- Lightweight shell provides excellent dexterity and cut resistance
- Hide-Away™ fibers hide dirt and grime



ANSI A3

MATA25HA
- Heavy gauge for increased durability and glove wear
- Hide-Away™ fibers hide dirt and grime



ANSI A3

MATA10-GY
- Medium gauge for improved dexterity
- Excellent use as a glove liner

EFFECTIVE AS LINER TOO

ATA™

STYLE	ANSI CUT	ZI CFR	MATERIAL	COLOR	CONSTRUCTION	GAUGE	WEIGHT	GRIP	SIZES	PROP 65
M530	A3	-	Kut Gard® ATA® Hide-Away™ Technology	Green	Seamless Knit	13	Lightweight	Uncoated	M-L	-
MATA110HA-OERTC2	A5	-	Kut Gard® ATA® Hide-Away™ Technology	Green	Seamless Knit, Reinforced Thumb Crotch	7	Heavyweight	Uncoated	S-L	-
MATA25HA	A3	-	Kut Gard® ATA® Hide-Away™ Technology	Green	Seamless Knit	7	Heavyweight	Uncoated	M	-
MATA30HA	A4	-	Kut Gard® ATA® Hide-Away™ Technology	Green	Seamless Knit	7	Heavyweight	Uncoated	S-XL	-
MATA500HA	A6	-	Kut Gard® ATA® Hide-Away™ Technology with Aramid	Green	Seamless Knit	7	Heavyweight	Uncoated	S-2XL	-
MATA501HA	A7	-	Kut Gard® ATA® Hide-Away™ Technology with Aramid	Green	Seamless Knit	7	Heavyweight	Uncoated	S-2XL	-
MATA10-GY	A3	-	Kut Gard® ATA® Technology	Gray	Seamless Knit	10	Medium Weight	Uncoated	L	-
MATA500	A6	-	Kut Gard® ATA® Technology with Aramid	Yellow	Seamless Knit	7	Heavyweight	Uncoated	S-2XL	-
MATA501	A7	-	Kut Gard® ATA® Technology with Aramid	Yellow	Seamless Knit	7	Heavyweight	Uncoated	S-2XL	-
MATA30PL	A4	-	Kut Gard® ATA® Technology with Cotton Plating	Yellow	Seamless Knit	7	Heavyweight	Uncoated	S-XL	-
MATAKV/BKPL30	A5	-	Kut Gard® ATA® with Aramid	Yellow	Seamless Knit	7	Heavyweight	Uncoated	XS-XL	-
MATA500ERTH	A7	-	Kut Gard® ATA® with Aramid	Yellow	Seamless Knit	7	Heavyweight	Uncoated	S-XL	-

C = **WARNING:** Cancer - www.P65Warnings.ca.gov R = **WARNING:** Reproductive Harm - www.P65Warnings.ca.gov CR = **WARNING:** Cancer and Reproductive Harm - www.P65Warnings.ca.gov



Scan it

**KUT
GARD®**

PolyKor®

ENGINEERED TO PROTECT AGAINST
MECHANICAL HAZARDS IN THE
TOUGHEST ENVIRONMENTS

Industrial / Construction / Automotive / Glass Manufacturing



ANSI
A9

09-H550SLPV

- Scrap King™ offers heavy-duty cut and abrasion resistance
- #1 choice for tough jobs
- Tough leather palm for extra protection

VEND READY

ANSI
A6

07-TW600

- Heavyweight shell provides excellent cut protection, performance and light heat protection
- Dark color helps hide dirt and grime

ANSI
A5

07-TW500

- Medium weight shell provides excellent cut protection, performance and light heat protection
- Dark color helps hide dirt and grime

ANSI
A5

14-ASP700PDD

- Double-sided PVC dots provide enhanced grip with extra cut and abrasion resistance
- 100% silicone-free

SECURE GRIP

ANSI
A4

14-PK700

- Exceptional value, exceptional abrasion resistance 3X greater than traditional para-aramid blend gloves
- 100% silicone-free

ANSI
A4

713DG

- Lightweight shell provides excellent cut protection, performance and dexterity
- Ambidextrous design

ANSI
A3

17-HX200

- PolyKor® Xrystal™ shell is lightweight and provides excellent dexterity, tactile sensitivity and cut resistance
- 100% silicone-free

ANSI
A3

730T

- Lightweight HPPE blended yarns offer exceptional cut and slash resistance
- 100% silicone-free
- Launderable

BEST SELLER

PROTECTION FROM HIGH CUT HAZARDS

Kut Gard® PolyKor®

STYLE	ANSI CUT	ZI CFR	MATERIAL	COLOR	CONSTRUCTION	GAUGE	WEIGHT	GRIP	GRIP COVERAGE	SIZES	PROP 65
07-TW500	A5	-	Kut Gard® PolyKor®	Green	Seamless Knit	7	Heavyweight	Uncoated	-	S-XL	-
07-TW600	A6	-	Kut Gard® PolyKor® ACP™	Green	Seamless Knit	7	Heavyweight	Uncoated	-	S-XL	-
09-H550SLPV	A9	-	Kut Gard® PolyKor®	Orange	Seamless Knit, Leather Palm, Reinforced Thumb Crotch	7	Heavyweight	Uncoated	-	S-2XL	-
14-ASP700PDD	A5	-	Kut Gard® PolyKor®	Salt & Pepper	Seamless Knit	7	Heavyweight	PVC	Double Sided	XXS-L	⚠️ C
14-PK700	A4	-	Kut Gard® PolyKor®	Black	Seamless Knit	7	Heavyweight	Uncoated	-	S-XL	-
17-HX200	A3	-	Kut Gard® PolyKor® Xrystal™	Gray	Seamless Knit, Reversible	13	Lightweight	Uncoated	-	L	-
713DG	A4	-	Kut Gard® made with HPPE	Gray	Seamless Knit	13	Lightweight	Uncoated	-	XXS-3XL	-
730T	A3	-	Kut Gard® made with HPPE	Gray	Seamless Knit	13	Lightweight	Uncoated	-	M-2XL	-
730TGLP	A5	-	Kut Gard® made with HPPE	Gray	Seamless Knit, Leather Palm, Reinforced Thumb Crotch	13	Lightweight	Uncoated	-	M-XL	-

C = ⚠️ **WARNING:** Cancer - www.P65Warnings.ca.gov

R = ⚠️ **WARNING:** Reproductive Harm - www.P65Warnings.ca.gov

C&R = ⚠️ **WARNING:** Cancer and Reproductive Harm - www.P65Warnings.ca.gov



Scan it

**KUT
GARD®**

Dyneema™

HIGH TENSILE STRENGTH, EXTREMELY
FLEXIBLE AND COOL WEARING

Industrial / Automotive / Glass Manufacturing



 <p>ANSI A3</p> <p>17-D350 - Heavyweight Dyneema™ shell provides light cut protection and abrasion resistance - Excellent for use as a glove liner</p>	 <p>ANSI A3</p> <p>17-DA720 - Lightweight ACP™ / Dyneema™ blended shell provides light cut protection and dexterity - Superior washability and resistance to chlorine bleach</p>	 <p>ANSI A3</p> <p>17-DL300 - Medium weight Dyneema™ / elastane blended shell provides good dexterity and cut resistance - Excellent for use as a glove liner</p> <p>ALSO AS HEAVY-DUTY LINER</p>	 <p>ANSI A2</p> <p>17-D200 - Lightweight Dyneema™ shell provides good dexterity and tactile sensitivity - Complies with FDA food handling requirements 21 CFR, Part 177</p>
 <p>ANSI A2</p> <p>17-D300 - Heavyweight Dyneema™ shell provides light cut protection and abrasion resistance - Complies with FDA food handling requirements 21 CFR, Part 177</p>	 <p>ANSI A2</p> <p>17-DL200 - Lightweight Dyneema™ / elastane blended shell provides good dexterity and tactile sensitivity - Excellent for use as a glove liner</p> <p>BEST AS LINER</p>	 <p>ANSI A2</p> <p>17-SD200 - Lightweight Spun Dyneema™ shell provides good dexterity and tactile sensitivity - Excellent for use as a glove liner</p>	 <p>ANSI A2</p> <p>17-SDG325 - Spun Dyneema™ nylon and nuaramid shell provides good dexterity and tactile sensitivity - Excellent use as a glove liner</p>

ULTIMATE COMFORT, COOLNESS AND DURABILITY

Kut Gard® with Dyneema™

STYLE	ANSI CUT	21 CFR	MATERIAL	COLOR	CONSTRUCTION	GAUGE	WEIGHT	GRIP	GRIP COVERAGE	SIZES	PROP 65
17-D200	A2	Yes	Kut Gard® with Dyneema™	White	Seamless Knit	13	Lightweight	Uncoated	-	XXS-XL	-
17-D300	A2	Yes	Kut Gard® with Dyneema™	White	Seamless Knit	7	Heavyweight	Uncoated	-	XS-XL	-
17-D350	A3	Yes	Kut Gard® with Dyneema™	White	Seamless Knit	7	Heavyweight	Uncoated	-	XS-XL	-
17-DL200	A2	Yes	Kut Gard® with Dyneema™	White	Seamless Knit	13	Lightweight	Uncoated	-	XS-XL	-
17-DL300	A3	Yes	Kut Gard® with Dyneema™	White	Seamless Knit	7	Heavyweight	Uncoated	-	XS-2XL	-
17-SD200	A2	Yes	Kut Gard® with Dyneema™	White	Seamless Knit	13	Lightweight	Uncoated	-	XS-XL	-
17-SD350	A2	Yes	Kut Gard® with Dyneema™	White	Seamless Knit	7	Heavyweight	Uncoated	-	XS-XL	-
17-SDG325	A2	Yes	Kut Gard® with Dyneema™	Gray	Seamless Knit	7	Heavyweight	Uncoated	-	S-XL	-
ACP™ with Dyneema™											
17-DA720	A3	Yes	Kut Gard® ACP™ with Dyneema™	Gray	Seamless Knit	13	Lightweight	Uncoated	-	S-XL	-

C = **WARNING:** Cancer - www.P65Warnings.ca.gov R = **WARNING:** Reproductive Harm - www.P65Warnings.ca.gov CR = **WARNING:** Cancer and Reproductive Harm - www.P65Warnings.ca.gov

SECTION:

General Purpose Gloves



CONFIDENCE TO DO THE JOB™

This section contains general purpose gloves designed to keep hands clean and protect the wearer's hands from scrapes and abrasion in low-risk work applications. PIP® offers a full range of economical general purpose gloves that combine comfort, protection and fit to suit any type of application.

General Purpose Coated Gloves are offered in a variety of materials that provide unique grip characteristics (see page 8 for more information on glove coatings). They offer a high degree of hand dexterity, tactile sensitivity, durability and abrasion resistance when compared to uncoated gloves.

General Purpose Uncoated Gloves are an economical solution to keeping hands protected in low-risk work applications. Commonly constructed of cotton, polyester and nylon yarns either in their pure form or in a blended form. With a reversible design, they can be replaced one at a time, instead of in pairs. They also function as added insulation as a glove liner for other styles of hand protection.

General Purpose Fabric Gloves are offered in a wide variety of materials, grades and styles. Cotton, cotton canvas and poly/cotton blended gloves are constructed of woven fabric cloth offered in a variety of weights and styles to provide soft, flexible comfort and good overall wear and durability. These glove materials meet two important requirements. First, the tightly woven fabric forms a barrier against dirt and grime. Secondly, the weave provides a strong surface to resist abrasion. Additionally, cotton is known to be one of the easiest fibers to wash; because of its excellent thermal properties it keeps its natural size after repeated drying.

Chore and Jersey Gloves are lightweight gloves used to keep hands clean and protect against scrapes and abrasions in low-risk work applications. Constructed of 100% cotton or cotton/polyester blends, these are the original cut and sewn type of hand protection, Clute cut with a straight thumb. New types include cotton canvas, double palm and dotted palm. They are used in general warehouse and shipping tasks, landscaping, light assembly, general maintenance and light automotive applications.

Leather General Purpose Gloves are economical, extremely durable, naturally heat resistant and provide outstanding flexibility and comfort. Leather comes in a variety of types and grades, each with unique characteristics that influence the glove's durability, puncture resistance, abrasion resistance, flexibility, insulation properties, moisture-resistance and breathability. Leather general purpose gloves are often used in construction, carpentry, general maintenance, agriculture and landscaping.



THERMAL



HEAT RESISTANCE



CONSTRUCTION



LANDSCAPING



AGRICULTURE



NeoFoam®

SECURE DRY & FLEXIBLE GRIP



Scan it

Handling, Assembly and Sorting of Small to Medium Parts and Materials / Shipping, Receiving and Packaging / Ideal for Maintenance and Repair Operations



34-600
- Lightweight liner for tasks that require a high degree of dexterity
- Thin flexible coating ideal for sorting and inspection

SKIN-LIKE DEXTERITY



34-603
- Extended coating over knuckles improves durability for highly repetitive tasks
- Ideal for light maintenance



34-605
- Double strand liner for tasks that require added strength and abrasion resistance
- Thin flexible coating ideal for small parts handling and light assembly

MULTI-TASKER



34-608
- Extended coating over knuckles improves durability for highly repetitive tasks
- Ideal for general maintenance



34-640
- Raised micro dotted pattern on palm and fingers increase durability
- Ideal for equipment operation in dry environments



34-643
- Extended coating coverage with micro dotted pattern on palm and fingers
- Ideal for fastening and assembly



34-645
- Raised micro dotted pattern on palm and fingers increase durability
- Ideal for carpentry and finish work/remodeling



34-648
- Extended coating coverage with micro dotted pattern on palm and fingers
- Ideal for general construction and repair

Blue LINER TECHNOLOGY

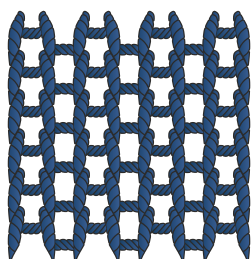

LIGHTER

For fine dexterity tasks

Earth tone LINER TECHNOLOGY

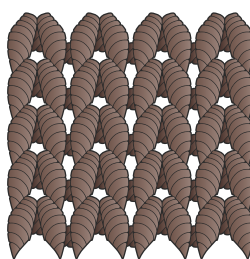

STRONGER

Double strand for a tighter, stronger work glove

STYLE	EN388	COATING	COATING COVERAGE	COATING COLOR	LINER MATERIAL	LINER COLOR	CONSTRUCTION	GAUGE	SIZES
34-600	4121	NeoFoam®	Palm & Fingers	Black	Nylon	Blue	Coated Seamless Knit, Touchscreen Compatible	15	XS-2XL
34-603	4121	NeoFoam®	Palm, Fingers & Knuckles	Black	Nylon	Blue	Coated Seamless Knit, Touchscreen Compatible	15	XS-2XL
34-605	4131	NeoFoam®	Palm & Fingers	Black	Nylon	Brown	Coated Seamless Knit, Touchscreen Compatible	15	S-2XL
34-608	4131	NeoFoam®	Palm, Fingers & Knuckles	Black	Nylon	Brown	Coated Seamless Knit, Touchscreen Compatible	15	S-2XL
34-640	4121	NeoFoam®	Palm & Fingers	Black	Nylon	Blue	Coated Seamless Knit, Touchscreen Compatible	15	XS-2XL
34-643	4121	NeoFoam®	Palm, Fingers & Knuckles	Black	Nylon	Blue	Coated Seamless Knit, Touchscreen Compatible	15	XS-2XL
34-645	4131	NeoFoam®	Palm & Fingers	Black	Nylon	Brown	Coated Seamless Knit, Touchscreen Compatible	15	S-2XL
34-648	4131	NeoFoam®	Palm & Fingers	Black	Nylon	Brown	Coated Seamless Knit, Touchscreen Compatible	15	S-2XL



Nitrile

**SECURE GRIP
AND OIL RESISTANT**



Scan it

Handling and Assembly of Parts and Materials / Equipment Maintenance and Repair / Parts Cleaning / Fastening and Anchoring



34-500
- Comfortable breathable liner for all-day use
- Ideal for light maintenance applications



34-C229
- Smooth coating finish will not absorb liquids
- Flat textured grip provides a tactile grip in dry conditions



34-C232
- Medium gauge liner for added abrasion resistance
- Ideal for general purpose jobs where dirt and oil are present



34-MP150
- Flexible TPR panels provide light back of hand impact protection
- Ideal for general purpose in tight, confined spaces



**ANSI/ISEA 138
1**
34-MP155
- Flexible TPR panels provide performance Level 1 impact protection
- Reinforced thumb crotch



715SNFFB
- Solid dipped nitrile provides excellent dry grip
- Full coverage, will not absorb liquids into the coating



Global Recycled Standard
31-330R
- Liner is made from recycled P.E.T. water bottles
- Compatible with light oils and provides excellent dry grip



Global Recycled Standard
31-530R
- Liner is made from recycled P.E.T. water bottles
- Excellent grip in wet, dry and oily conditions

STYLE	EK388	ANSI/ISEA 138	COATING	COATING COVERAGE	COATING COLOR	LINER MATERIAL	LINER COLOR	CONSTRUCTION	GAUGE	SIZES	PROP 65
31-330R	4121X	-	Nitrile Foam	Palm & Fingers	Gray	Recycled Material	White	Coated Seamless Knit	13	XS-2XL	-
31-530R	4121X	-	Nitrile MicroSurface	Palm & Fingers	Gray	Recycled Material	White	Coated Seamless Knit	13	XS-2XL	-
34-225	4121	-	Nitrile Smooth	Palm & Fingers	Gray	Nylon	White	Coated Seamless Knit	13	XS-XL	-
34-300	4121	-	Nitrile MicroSurface	Palm & Fingers	Black	Polyester	Gray	Coated Seamless Knit	13	XS-2XL	-
34-400	4111	-	Nitrile MicroSurface	Palm & Fingers	Black	Nylon	Green	Coated Seamless Knit	18	XS-2XL	-
34-500	4121	-	Nitrile MicroSurface	Palm & Fingers	Blue	Nylon	Blue	Coated Seamless Knit	13	XS-2XL	-
34-C229	4131	-	Nitrile Smooth	Palm & Fingers	Blue	Nylon	White	Coated Seamless Knit	13	S-XL	-
34-C232	4121	-	Nitrile Foam	Palm & Fingers	Black	Nylon	Gray	Coated Seamless Knit	13	XS-XL	-
34-C234	4131	-	Nitrile Foam	Palm & Fingers	Gray	Nylon	White	Coated Seamless Knit	13	XS-XL	-
34-MP150	4121X	Impact TPR	Nitrile Foam	Palm & Fingers	Black	Nylon	Black	Coated Seamless Knit	15	M-2XL	-
34-MP155	4121XP	Impact Level 1	Nitrile Foam	Palm & Fingers	Black	Nylon	Black	Coated Seamless Knit, Reinforced Thumb Crotch	15	M-2XL	-
701CRNF	3132A	-	Nitrile Foam	Palm & Fingers	Black	Nylon	Red	Coated Seamless Knit	15	S-XL	-
715SBMF	4131X	-	Nitrile Foam	Palm & Fingers	Black	Nylon	Gray	Coated Seamless Knit	15	XS-2XL	-
715SBWRND	-	-	Nitrile Sandy	Palm, Fingers & Knuckles	Black	Acrylic	Black	Coated Seamless Knit	15	S-2XL	-
715SNFB	3132X	-	Nitrile Foam	Palm & Fingers	Black	Nylon	Black	Coated Seamless Knit	15	S-XL	-
715SNFFB	4121X	-	Nitrile Smooth	Full Hand	Black	Nylon	Black	Coated Seamless Knit	15	S-2XL	-
715SNFKB	3132X	-	Nitrile Foam	Palm, Fingers & Knuckles	Black	Nylon	Black	Coated Seamless Knit	15	S-XL	-
715SNFLB	3131X	-	Nitrile Foam	Palm & Fingers	Black	Nylon	Salt & Pepper	Coated Seamless Knit	15	XS-2XL	-
715SNFLW	3131X	-	Nitrile Foam	Palm & Fingers	Gray	Nylon	White	Coated Seamless Knit	15	XS-2XL	-
715SNFP	4121X	-	Nitrile Foam	Palm & Fingers	Gray	Nylon	White	Coated Seamless Knit	15	XS-XL	-
715SNFTK	4141X	-	Nitrile Foam	Palm, Fingers & Knuckles	Black	Nylon	Gray	Coated Seamless Knit	15	S-2XL	-
715SNFTKD	4141X	-	Nitrile Foam	Palm, Fingers & Knuckles	Black	Nylon	Gray	Coated Seamless Knit	15	S-2XL	-
715SNFTP	4141X	-	Nitrile Foam	Palm & Fingers	Black	Nylon	Gray	Coated Seamless Knit	15	S-2XL	-
HVY713NFB	4142	Impact TPR	Nitrile Foam	Palm & Fingers	Hi-Vis Yellow	Polyester	Hi Vis Yellow	Coated Seamless Knit	13	S-2XL	-
HVY715YNF	4141X	-	Nitrile Foam	Palm & Fingers	Hi-Vis Yellow	Nylon	Hi Vis Yellow	Coated Seamless Knit	15	S-2XL	-

C = **WARNING:** Cancer - www.P65Warnings.ca.gov

R = **WARNING:** Reproductive Harm - www.P65Warnings.ca.gov

C&R = **WARNING:** Cancer and Reproductive Harm - www.P65Warnings.ca.gov



Nitrile MicroFoam

MAXIMUM BREATHABILITY,
COMFORT & DURABILITY



Scan it

Handling, Assembly and Sorting of
Small Parts and Materials / Finishing
and Parts Inspection / Light
Maintenance and Repair



▲ 34-8014



▲ 34-874



▲ 34-874FY



▲ 34-875



▲ 34-876

MAXIFLEX® ULTIMATE™

- High tactile sensitivity and dexterity
- Designed and developed with 360° breathability through the use of ATG's patented AIRtech™ platform
- Micro-cup finish provides excellent dry grip and compatibility with light oils
- Made with component materials that comply with federal regulations for food contact 21 CFR, 170-199
- Silicone-free



▲ 34-844



▲ 34-845



▲ 34-846



▲ 34-8745

Raised
micro-dots
for more
durability

MAXIFLEX® ENDURANCE™

- High tactile sensitivity and dexterity
- Patented Micro-Foam nitrile coating offers 360° breathability
- Micro-cup finish provides excellent dry grip and compatibility with light oils
- Made with component materials that comply with federal regulations for food contact 21 CFR, 170-199
- Micro-dots provide increased durability

MaxiFlex® Ultimate™

STYLE	EN388	21CFR	CFIA	COATING	COATING COVERAGE	COATING COLOR	LINER MATERIAL	LINER COLOR	CONSTRUCTION	GAUGE	SIZES	PROP 65
34-8014	4131	Yes	Yes	Nitrile Micro-Foam	Palm & Fingers	Black	Nylon / Spandex	Hi-Vis Orange	Coated Seamless Knit	15	S-2XL	-
34-874	4131	Yes	Yes	Nitrile Micro-Foam	Palm & Fingers	Black	Nylon / Spandex	Gray	Coated Seamless Knit	15	XXS-3XL	-
34-874FY	4131	Yes	Yes	Nitrile Micro-Foam	Palm & Fingers	Hi-Vis Yellow	Nylon / Spandex	Hi-Vis Yellow	Coated Seamless Knit	15	S-2XL	-
34-874V	4131	Yes	Yes	Nitrile Micro-Foam	Palm & Fingers	Black	Nylon / Spandex	Gray	Coated Seamless Knit	15	XXS-3XL	-
34-875	4131	Yes	Yes	Nitrile Micro-Foam	Palm, Fingers & Knuckles	Black	Nylon / Spandex	Gray	Coated Seamless Knit	15	XXS-XL	-
34-875V	4131	Yes	Yes	Nitrile Micro-Foam	Palm, Fingers & Knuckles	Black	Nylon / Spandex	Gray	Coated Seamless Knit	15	XXS-XL	-
34-876	4131	Yes	Yes	Nitrile Micro-Foam	Full Hand	Black	Nylon / Spandex	Gray	Coated Seamless Knit	15	XXS-2XL	-
42-874	4131	Yes	Yes	Nitrile Micro-Foam	Palm & Fingers	Black	Nylon / Spandex	Gray	Coated Seamless Knit	15	XS-2XL	-
34-846T**	4131	Yes	Yes	Nitrile Micro-Foam	Full Hand	Black	Nylon / Spandex	Gray	Coated Seamless Knit	15	M-2XL	-
34-874T**	4131	Yes	Yes	Nitrile Micro-Foam	Palm & Fingers	Black	Nylon / Spandex	Gray	Coated Seamless Knit	15	XS-2XL	-

MaxiFlex® Endurance™

34-844	4131	Yes	Yes	Nitrile MicroFoam w/ Micro Dots	Palm & Fingers	Black	Nylon / Spandex	Gray	Coated Seamless Knit, dotted palm	15	XXS-XL	-
34-845	4131	Yes	Yes	Nitrile MicroFoam w/ Micro Dots	Palm, Fingers & Knuckles	Black	Nylon / Spandex	Gray	Coated Seamless Knit, dotted palm	15	XXS-2XL	-
34-846	4131	Yes	Yes	Nitrile MicroFoam w/ Micro Dots	Full Hand	Black	Nylon / Spandex	Gray	Coated Seamless Knit, dotted palm	15	XXS-2XL	-
34-8745	4131	Yes	Yes	Nitrile MicroFoam w/ Micro Dots	Full Hand	Black	Nylon / Spandex	Black	Coated Seamless Knit, dotted palm	15	S-2XL	-

* Vend version available

** Tagged version available



Nitrile MicroFoam

MAXIMUM BREATHABILITY,
COMFORT & DURABILITY



Scan it

Handling and Assembly and Sorting
of Small Parts and Materials / Quality
Control and Inspection / 21 CFR -
Indirect Food Contact



MICRO DOTS

▲ 34-244

▲ 34-274

MAXIFLEX® ELITE™

- Maximum dexterity and tactility
- 360° breathability
- Micro-cup finish provides excellent dry grip and compatibility with light oils
- Silicone-free
- Made with component materials that comply with federal regulations for food contact 21 CFR, 170-199



ANTI-STATIC

34-774B

- Anti-static, complies with EN 16350-2014 for electrostatic protective gloves
- Ultra-lightweight at 14 grams per pair

Unparalleled
dexterity and
tactile sensitivity



34-900

- High dexterity and tactility
- Lighter coating for improved flexibility and dexterity
- Silicone-free



34-800

- High dexterity and tactility
- Tough foam nitrile coating for improved grip and durability
- Silicone-free



MADE WITH ALOE VERA & VITAMIN E

34-8264

- High tactile sensitivity and dexterity
- 360° breathability
- Micro-cup finish provides excellent dry grip and compatibility with light oils



34-9025

- 100% silicone-free
- Made with component materials that comply with federal regulations food contact 21 CFR, 170-199

MaxiFlex® Elite™

STYLE	EN388	21 CFR	CFIA	COATING	COATING COVERAGE	COATING COLOR	LINER MATERIAL	LINER COLOR	CONSTRUCTION	GAUGE	SIZES	PROPS
34-244	4121	Yes	Yes	Nitrile MicroFoam w/ Micro Dots	Palm & Fingers	Blue	Nylon / Spandex	Blue	Coated Seamless Knit	18	XS-XL	-
34-274	4121	Yes	Yes	Nitrile Micro-Foam	Palm & Fingers	Blue	Nylon / Spandex	Blue	Coated Seamless Knit	18	XS-2XL	-
34-774B	4121	Yes	Yes	Nitrile Micro-Foam	Palm & Fingers	Black	Nylon / Spandex	Gray	Coated Seamless Knit	18	XS-2XL	-
MaxiFlex® Active												
34-824	4131	Yes	Yes	Nitrile Micro-Foam	Palm & Fingers	Light Blue	Nylon / Spandex	Light Blue	Coated Seamless Knit	15	XS-XL	-
34-8264	4131	Yes	Yes	Nitrile Micro-Foam	Palm & Fingers	Pink	Nylon / Spandex	Pink	Coated Seamless Knit	15	XXS-XL	-
MaxiFlex® Comfort™												
34-9025	3141	Yes	Yes	Nitrile Micro-Foam	Palm, Fingers & Knuckles	Blue	Nylon / Cotton / Spandex	Gray	Coated Seamless Knit	15	S-XL	-
MaxiFoam®												
34-900	3121	Yes	Yes	Nitrile Micro-Foam	Palm & Fingers	Black	Nylon / Spandex	Gray	Coated Seamless Knit	15	XS-2XL	-
34-900V*	3121	Yes	Yes	Nitrile Micro-Foam	Palm & Fingers	Black	Nylon / Spandex	Gray	Coated Seamless Knit	15	XS-2XL	-
34-800	4131	Yes	Yes	Nitrile Micro-Foam	Palm & Fingers	Gray	Nylon / Spandex	White	Coated Seamless Knit	15	XXS-2XL	-
34-800V*	4131	Yes	Yes	Nitrile Micro-Foam	Palm & Fingers	Gray	Nylon / Spandex	White	Coated Seamless Knit	15	XXS-2XL	-

* Vend version available



Nitrile MicroFoam



**TOUGH &
OIL RESISTANT GRIP**

Handling, Assembling and Sorting of Light Oily Parts and Materials / General Maintenance and Repair / Indirect Food Handling and Cold Storage Applications



Scan it



▲ 56-424

▲ 56-425

▲ 56-426

MAXIDRY®

- High dexterity
- Comfortable
- Micro-cup finish provides excellent dry grip and compatibility with light oils
- Dark liner and coating hides dirt

STYLE	EN388	Z1CFR	CFR	COATING	COATING COVERAGE	COATING COLOR	LINER MATERIAL	LINER COLOR	CONSTRUCTION	GAUGE	SIZES	PROP 65
56-424	4121	Yes	Yes	Nitrile Micro-Foam	Palm & Fingers	Black	Nylon / Spandex	Purple	Coated Seamless Knit	15	XS-2XL	-
56-425	4121	Yes	Yes	Nitrile Micro-Foam	Palm, Fingers & Knuckles	Black	Nylon / Spandex	Purple	Coated Seamless Knit	15	XS-2XL	-
56-426	4111	Yes	Yes	Nitrile Micro-Foam	Full Hand	Black	Nylon / Spandex	Purple	Coated Seamless Knit	15	S-2XL	-

Superior grip in oily and wet applications



Latex



SECURE GRIP WET OR DRY,
TEAR & PUNCTURE RESISTANT

Handling and Cleanup of Abrasive Parts
and Materials / Demolition / Masonry and
Tile / Metal Fastening and Assembly



Scan it



39-C1300
- Tough flexible
tear-resistant
crinkle coating
- Comfortable cotton/
polyester lining
provides good
abrasion resistance



39-C1600
- Economical cotton/
polyester liner
provides good
abrasion resistance
- Latex with MicroSurface
finish provides good
wet grip



COLD WEATHER

41-1420
- Terry liner provides
excellent thermal
insulation
- Ideal for transportation
and snow clearing
applications where
visibility is required



41-1425
- Acrylic liner provides
an economical
alternative for cold
weather applications
- Soft and comfortable,
quickly evaporates
moisture from the skin



55-1600
- Waterproof coating
keeps hands dry
- Excellent dexterity
and comfort
- Double-coated palm
for added durability



55-AG316
- High tactile sensitivity
and dexterity
- MicroSurface finish
provides secure dry
and good wet grip
- Lightweight and
comfortable polyester liner



HIGH VISIBILITY

55-AG317
- High tactile sensitivity
and dexterity
- Ideal for loading
and unloading
material where
visibility is required



715SLC
- Added coating
coverage over knuckles
- Hard-wearing
alternative for handling
abrasive material or
landscaping

STYLE	ENC388	COATING	COATING COVERAGE	COATING COLOR	LINER MATERIAL	LINER COLOR	CONSTRUCTION	GAUGE	SIZES	PROP 65
32L710	1121X	Latex Crinkle	Palm & Fingers	Blue	Acrylic	Hi-Vis Yellow	Coated Seamless Knit	10	M-XL	-
39-1310	2142	Latex Crinkle	Palm & Fingers	Blue	Cotton Polyester	Gray	Coated Seamless Knit	10	XS-2XL	-
39-C120	2011	Latex Smooth	Palm & Fingers	Blue	Cotton Polyester	Natural	Coated Seamless Knit	7	L	-
39-C121	2011	Latex Smooth	Palm & Fingers	Red	Cotton Polyester	Natural	Coated Seamless Knit	7	S-L	-
39-C122	2011	Latex Smooth	Palm & Fingers	Blue	Cotton Polyester	Natural	Coated Seamless Knit	7	S-XL	-
39-C1300	2142	Latex Crinkle	Palm & Fingers	Blue	Cotton Polyester	Gray	Coated Seamless Knit	10	XS-2XL	-
39-C1305	2142	Latex Crinkle	Palm & Fingers	Blue	Cotton Polyester	Gray	Coated Seamless Knit	10	XS-XL	-
39-C1500	3242	Latex MicroFinish®	Palm & Fingers	Brown	Cotton Polyester	Brown	Coated Seamless Knit	10	XS-XL	-
39-C1600	3242	Latex MicroFinish®	Palm & Fingers	Blue	Cotton Polyester	Gray	Coated Seamless Knit	10	XS-XL	-
41-1400	2230X	Latex MicroFinish®	Palm & Fingers	Brown	Acrylic	Hi-Vis Orange	Coated Seamless Knit	10	S-2XL	-
41-1405	12310X	Latex MicroFinish®	Palm & Fingers	Brown	Acrylic	Hi-Vis Yellow	Coated Seamless Knit	10	S-2XL	-
41-1420	12210X	Latex Crinkle	Palm & Fingers	Black	Acrylic	Hi-Vis Yellow	Coated Seamless Knit	7	S-XL	-
41-1425	31320X	Latex Crinkle	Palm & Fingers	Black	Acrylic	Hi-Vis Yellow	Coated Seamless Knit	10	S-2XL	-
41-1430	32310X	Latex MicroFinish®	Palm & Fingers	Brown	Polyester / Acrylic	Black	Coated Seamless Knit	10	S-2XL	-
41-1475	21210X	Latex MicroFinish®	Palm, Fingers & Knuckles	Brown	Acrylic	Hi-Vis Orange	Coated Seamless Knit	10	S-2XL	-
55-1600	2141	Latex MicroSurface	Full Hand	Dark Blue	Polyester	Blue	Coated Seamless Knit Waterproof	13	S-2XL	⚠️ R
55-AG316	2121	Latex MicroSurface	Palm & Fingers	Black	Polyester	Blue	Coated Seamless Knit	13	XS-XL	-
55-AG317	2121	Latex MicroSurface	Palm & Fingers	Black	Polyester	Hi-Vis Yellow	Coated Seamless Knit	13	XS-2XL	-
708SLC	-	Latex Smooth	Palm & Fingers	Blue	Cotton Polyester	Natural	Coated Seamless Knit	7	MENS-XL	-
713SLC	3221X	Latex Crinkle	Palm & Fingers	Black	Nylon	Gray	Coated Seamless Knit	13	S-2XL	-
715SLC	3131X	Latex Crinkle	Palm, Fingers & Knuckles	Black	Nylon	Blue	Coated Seamless Knit	15	S-XL	-
HVG700SLC	2242X	Latex Crinkle	Palm & Fingers	Black	Cotton Polyester	Hi-Vis Yellow	Coated Seamless Knit	10	S-XL	-
HVG700SLC	2242X	Latex Crinkle	Palm & Fingers	Black	Cotton Polyester	Hi-Vis Orange	Coated Seamless Knit	10	L-XL	-

C = ⚠️ WARNING: Cancer - www.P65Warnings.ca.gov

R = ⚠️ WARNING: Reproductive Harm - www.P65Warnings.ca.gov

C&R = ⚠️ WARNING: Cancer and Reproductive Harm - www.P65Warnings.ca.gov



Polyurethane



THIN COATING, GOOD GRIP FOR
HIGH DEXTERITY HANDLING



Scan it

Small Parts Handling / General
Maintenance / Quality Control
and Inspection / MRO



EN374-5



33-VRX180

- Ultra-lightweight 18-gauge nylon liner delivers outstanding dexterity and tactile sensitivity
- Machine washable up to 6 wash cycles without negatively impacting coating properties

TOUCHSCREEN COMPATIBLE



HIGH VISIBILITY

33-425LY

- Lightweight breathable nylon glove liner
- Good dexterity and tactile sensitivity
- Hi-Vis for enhanced visibility



33-825

- Lightweight breathable nylon glove liner
- Green color provides added visibility
- Good abrasion protection



33-125

- Lightweight breathable glove liner
- White color ideal for inspection and clean applications

33-125V *Vend Ready*



33-325

- Extra thick coating provides added abrasion resistance
- Breathable back for added comfort
- Black liner and coating hides dirt



BEST TOUCHSCREEN

33-GT125

- Lightweight polyester/nylon liner provides good dexterity and tactile sensitivity
- Touchscreen compatible



MADE FROM RECYCLED WATER BOTTLES



31-131R

- Liner is made from recycled P.E.T. water bottles
- Excellent dexterity and tactile sensitivity



703COPB

- Durable heavy gauge liner provides added abrasion resistance
- Hi-Vis for enhanced visibility

STYLE	EN388	EN374-5	COATING	COATING COVERAGE	COATING COLOR	LINER MATERIAL	LINER COLOR	CONSTRUCTION	GAUGE	SIZES	PROP 65
31-131R	3121X	-	Polyurethane Smooth	Palm & Fingers	Gray	Recycled Material	White	Coated Seamless Knit	13	XS-2XL	▲ ^C
33-115	3121	-	Polyurethane Smooth	Palm & Fingers	White	Polyester	White	Coated Seamless Knit	13	XS-2XL	▲ ^C
33-125	4131AX	-	Polyurethane Smooth	Palm & Fingers	White	Nylon	White	Coated Seamless Knit	13	XS-2XL	▲ ^C
33-325	4131	-	Polyurethane Smooth	Palm & Fingers	Black	Nylon	Black	Coated Seamless Knit	13	XS-2XL	▲ ^C
33-425LY	3131AX	-	Polyurethane Smooth	Palm & Fingers	Hi-Vis Yellow	Nylon	Hi-Vis Yellow	Coated Seamless Knit	13	XS-2XL	▲ ^C
33-425OR	3131AX	-	Polyurethane Smooth	Palm & Fingers	Hi-Vis Orange	Nylon	Hi-Vis Orange	Coated Seamless Knit	13	XS-2XL	▲ ^C
33-825	3121AX	-	Polyurethane Smooth	Palm & Fingers	Black	Nylon	Green	Coated Seamless Knit	13	XS-2XL	▲ ^C
33-8115	3121	-	Polyurethane Smooth	Palm & Fingers	Black	Polyester	Black	Coated Seamless Knit	13	XXS-2XL	▲ ^C
33-8125	4131AX	-	Polyurethane Smooth	Palm & Fingers	Black	Nylon	Black	Coated Seamless Knit	13	XS-2XL	▲ ^C
33-6115	3121	-	Polyurethane Smooth	Palm & Fingers	Gray	Polyester	Gray	Coated Seamless Knit	13	XS-2XL	▲ ^C
33-6125	4131AX	-	Polyurethane Smooth	Palm & Fingers	Gray	Nylon	Gray	Coated Seamless Knit	13	XS-3XL	▲ ^C
33-GT125	4131	-	Polyurethane Smooth	Palm & Fingers	Gray	Nylon Polyester	Gray	Coated Seamless Knit, Touchscreen Compatible	13	XS-2XL	▲ ^C
33-VRX180	4X32C	Yes	Polyurethane	Full Hand	Black	PolyKor™	Blue	Coated Seamless Knit	18	XS-2XL	▲ ^C
34-300	4121X	-	Polyurethane Smooth	Palm & Fingers	Black	G-Tek®	Gray	Coated Seamless Knit	13	XS-2XL	▲ ^C
701CRPB	4131A	-	Polyurethane Smooth	Palm & Fingers	Black	Nylon	Red	Coated Seamless Knit	15	S-2XL	▲ ^C
703COPB	4343B	-	Polyurethane Smooth	Palm & Fingers	Black	HPPE	Hi-Vis Orange	Coated Seamless Knit	10	S-2XL	▲ ^C
713SUCG	4131X	-	Polyurethane Smooth	Palm & Fingers	Gray	Nylon	Gray	Coated Seamless Knit	13	XS-2XL	▲ ^C
1PU3000	4131X	-	Polyurethane Smooth	Palm & Fingers	Gray	Nylon	Gray	Coated Seamless Knit	13	6-11	▲ ^C
PVC Coated											
32-747	3131	-	PVC	Palm & Fingers	Black	Nylon	Black	Coated Seamless Knit	15	XS-XL	-

C = ▲ **WARNING:** Cancer - www.P65Warnings.ca.gov

R = ▲ **WARNING:** Reproductive Harm - www.P65Warnings.ca.gov

C&R = ▲ **WARNING:** Cancer and Reproductive Harm - www.P65Warnings.ca.gov



Scan it

COATED SEAMLESS KNIT GENERAL PURPOSE GLOVES

Quick Find Index

ENHANCED PERFORMANCE FEATURES



TOUCHSCREEN

With the rapid increase in technology in the workplace, especially in factories and manufacturing plants where cut-resistant work gloves are used, touchscreen compatibility has never been more important. Use this index to locate gloves that combine cut resistance and touchscreen compatibility for increased safety and efficiency.



SILICONE FREE

Silicone is an excellent lubricant and release agent frequently found in manufacturing. These same properties are a major concern in coating or bonding applications, such as automotive finishing. The slightest trace of silicone can result in adhesive failure, resulting in poor quality finishes that cost time and drain resources to repair. Use this index to locate gloves that required for silicone-free applications.



21 CFR

Cross-contamination of one item or surface onto another can cause serious illnesses or allergic reactions. Coated seamless knit gloves are ideal for indirect contact in food plants for MRO applications or sorting and packaging tasks where the contact is incidental, or when the contact is not purposeful or continuous. Use this index to locate gloves that are ideal for indirect food contact applications.



STYLE NUMBER	DESCRIPTION	COATING	TOUCHSCREEN COMPATIBLE	SILICONE-FREE	21CFR
33-B115	G-Tek®	Polyurethane		•	
33-B125	G-Tek®	Polyurethane		•	
33-G115	G-Tek®	Polyurethane		•	
33-G125	G-Tek®	Polyurethane		•	
33-GT125	G-Tek®	Polyurethane	•	•	
33-VRX180	G-Tek® VR-X™	Polyurethane	•	•	
34-600	G-Tek® NeoFoam®	NeoFoam® Foam	•		•
34-603	G-Tek® NeoFoam®	NeoFoam® Foam	•		•
34-605	G-Tek® NeoFoam®	NeoFoam® Foam	•		•
34-608	G-Tek® NeoFoam®	NeoFoam® Foam	•		•
34-640	G-Tek® NeoFoam®	NeoFoam® Foam	•		•
34-643	G-Tek® NeoFoam®	NeoFoam® Foam	•		•
34-645	G-Tek® NeoFoam®	NeoFoam® Foam	•		•
34-648	G-Tek® NeoFoam®	NeoFoam® Foam	•		•
34-774B	MaxiFlex® Elite™	Nitrile Micro-Foam	•		•
34-800	MaxiFoam® Premium	Nitrile Micro-Foam		•	•
34-8014	MaxiFlex® Ultimate™	Nitrile Micro-Foam		•	
34-824	MaxiFlex® Active	Nitrile Micro-Foam		•	•
34-8264	MaxiFlex® Active	Nitrile Micro-Foam		•	
34-844	MaxiFlex® Endurance™	Nitrile Micro-Foam	•		•
34-845	MaxiFlex® Endurance™	Nitrile Micro-Foam	•	•	•
34-846	MaxiFlex® Endurance™	Nitrile Micro-Foam	•	•	•
34-874	MaxiFlex® Ultimate™	Nitrile Micro-Foam	•	•	•
34-8745	MaxiFlex® Endurance™	Nitrile Micro-Foam	•	•	•
34-874FY	MaxiFlex® Ultimate™	Nitrile Micro-Foam		•	•
34-875	MaxiFlex® Ultimate™	Nitrile Micro-Foam	•	•	
34-876	MaxiFlex® Ultimate™	Nitrile Micro-Foam	•	•	
34-900	MaxiFoam® Lite	Nitrile Micro-Foam		•	•
34-9025	MaxiFlex® Comfort™	Nitrile Micro-Foam		•	•
41-1400	PowerGrab™ Thermo	Latex MicroFinish®			•
41-1405	PowerGrab™ Thermo	Latex MicroFinish®			•
42-874	MaxiFlex® Ultimate™ AD-APT™	Nitrile Micro-Foam	•	•	•
56-451	MaxiDry® Zero™	Nitrile Micro-Foam			•
701CRNF	G-Tek®	Nitrile Foam		•	
701CRPB	G-Tek®	Polyurethane		•	
715SNFB	G-Tek®	Nitrile Foam		•	
715SNFFB	G-Tek®	Nitrile Smooth		•	
715SNFLB	G-Tek®	Nitrile Foam		•	
715SNFLW	G-Tek®	Nitrile Foam		•	



Scan it

COATED SEAMLESS KNIT GENERAL PURPOSE GLOVES

Vend-ready solutions

PACKAGED FOR VENDING MACHINES



FREQUENTLY USED
ITEMS



OPTIMALLY SIZED
FOR MOST MACHINES



BARCODED PACKAGING FOR
INVENTORY CONTROL

The most comprehensive line of vend packed gloves

IN STOCK VEND-READY SOLUTIONS

STYLE NUMBER	EN388	COATING	COATING COVERAGE	COATING COLOR	LINER MATERIAL	LINER COLOR	CONSTRUCTION	GAUGE	SIZE	PROP 65
33-125V	4131A	Polyurethane	Palm & Fingers	White	Nylon	White	Coated Seamless Knit	13	XS-2XL	⚠️ ^C
33-8125V	4131A	Polyurethane	Palm & Fingers	Black	Nylon	Black	Coated Seamless Knit	13	XS-2XL	⚠️ ^C
33-6125V	4131A	Polyurethane	Palm & Fingers	Gray	Nylon	Gray	Coated Seamless Knit	13	XS-3XL	⚠️ ^C
34-225V	4121	Nitrile Smooth	Palm & Fingers	Black	Nylon	White	Coated Seamless Knit	13	S-XL	
34-500V	4121	Nitrile MicroSurface	Palm & Fingers	Black	Nylon	Blue	Coated Seamless Knit	13	XS-2XL	
34-800V	4131	Nitrile Micro-foam	Palm & Fingers	Gray	Nylon / Spandex	White	Coated Seamless Knit	15	2XS-2XL	
34-874V	4131A	Nitrile Micro-foam	Palm & Fingers	Black	Nylon / Spandex	Gray	Coated Seamless Knit	15	2XS-3XL	
34-875V	4131	Nitrile Micro-foam	Palm, Fingers & Knuckles	Black	Nylon / Spandex	Gray	Coated Seamless Knit	15	2XS-XL	
34-900V	3121	Nitrile Micro-foam	Palm & Fingers	Black	Nylon / Spandex	Gray	Coated Seamless Knit	15	XS-2XL	
39-1310V	2142	Latex Crinkle	Palm & Fingers	Blue	Cotton / Polyester	White	Coated Seamless Knit	10	S-XL	

C=⚠️ **WARNING:** Cancer - www.P65Warnings.ca.gov R=⚠️ **WARNING:** Reproductive Harm - www.P65Warnings.ca.gov CR=⚠️ **WARNING:** Cancer and Reproductive Harm - www.P65Warnings.ca.gov



String Knits with Pattern Grip



Warehousing and Package Handling /
Construction / General Assembly /
Light Duty General Work



Scan it



36-110BB

- Double-sided PVC
"brick" pattern
provides enhanced
grip and extra cut and
abrasion resistance



36-110PC-BK

- Smooth PVC palm
coating provides
enhanced dry grip
and extra cut and
abrasion resistance



36-110PD

- Single-sided PVC dots
provide enhanced
grip and extra cut and
abrasion resistance



37-C110BB

- Double-sided PVC
"brick" pattern
provides enhanced
grip and extra cut and
abrasion resistance



37-C110PC-BK

- Smooth PVC palm
coating provides
enhanced dry grip
and extra cut and
abrasion resistance



37-C110PDD

- Double-sided PVC dots
provide enhanced
grip and extra cut and
abrasion resistance

STYLE	COATING	COATING COVERAGE	COATING COLOR	LINER MATERIAL	LINER COLOR	CONSTRUCTION	GAUGE	SIZES	PROP 65
36-110BB	PVC Pattern	Double-Sided	Blue	Cotton Polyester	Natural	Coated Seamless Knit	7	S-L	
36-110PC-BK	PVC Smooth	One Side	Black	Cotton Polyester	Natural	Coated Seamless Knit	7	XS-L	
36-110PD	PVC Dot	One Side	Black	Cotton Polyester	Natural	Coated Seamless Knit	7	XS-L	
36-110PDD	PVC Dot	Double-Sided	Black	Cotton Polyester	Natural	Coated Seamless Knit	7	XS-L	
36-110VV	PVC Pattern	Double-Sided	Blue	Cotton Polyester	Natural	Coated Seamless Knit	7	S-L	
36-C330PD	PVC Dot	One Side	Blue	Cotton Polyester	Natural	Coated Seamless Knit	7	S-L	
36-C330PDD	PVC Dot	Double-Sided	Blue	Cotton Polyester	Natural	Coated Seamless Knit	7	S-L	
37-C110B	PVC Pattern	One Side	Blue	Cotton Polyester	Natural	Coated Seamless Knit	7	S-L	⚠️ C
37-C110BB	PVC Pattern	Double-Sided	Blue	Cotton Polyester	Natural	Coated Seamless Knit	7	S-L	⚠️ C
37-C110PC-BK	PVC Smooth	One Side	Black	Cotton Polyester	Natural	Coated Seamless Knit	7	S-L	⚠️ C
37-C110PC-BL	PVC Smooth	One Side	Blue	Cotton	Natural	Coated Seamless Knit	7	S-L	⚠️ C
37-C110PD	PVC Dot	One Side	Black	Cotton Polyester	Natural	Coated Seamless Knit	7	S-L	⚠️ C
37-C110PDD	PVC Dot	Double-Sided	Black	Cotton Polyester	Natural	Coated Seamless Knit	7	XS-L	⚠️ C
37-C112PDD	PVC Dot	Double-Sided	Black	Cotton Polyester	Natural	Coated Seamless Knit	7	S-L	⚠️ C
37-C119PDD	PVC Dot	Double-Sided	Black	Cotton Polyester	Natural	Coated Seamless Knit, Half Finger	7	S-L	⚠️ C

C=⚠️ WARNING: Cancer - www.P65Warnings.ca.gov R=⚠️ WARNING: Reproductive Harm - www.P65Warnings.ca.gov C&R=⚠️ WARNING: Cancer and Reproductive Harm - www.P65Warnings.ca.gov



37-C2110PC-BL

- Seamless knit 10-gauge shell is comfortable, flexible and dexterous



37-C500PDD

- Double-sided PVC dots provide enhanced grip and extra cut and abrasion resistance



37-C512PDD-BL

- Knit wrist helps prevent dirt and debris from entering the glove
- PVC dots provide enhanced grip, performance and durability



38-1410

- Nitrile coating provides excellent dry grip and will not absorb liquids into the coating
- Ergonomic shaped curved finger pattern



38-720

- Double-sided Nitrile "MW" pattern provides superior grip
- Coated with a special formulated nitrile to resist melting



38-N2110PC

- Nitrile palm coating provides superior grip and abrasion resistance
- Curved finger style provides an ergonomic, comfortable fit



39-3013

- Double-sided PVC "honeycomb criss-cross" pattern provides enhanced grip and extra cut and abrasion resistance



K708SKBSL

- Double-sided PVC dots provide enhanced grip and extra cut and abrasion resistance
- Sized to fit female hands

Designed to provide lasting protection, durability and comfort

PVC DOTS PROVIDE ENHANCED GRIP AND ABRASION RESISTANCE

STYLE	COATING	COATING COVERAGE	COATING COLOR	LINER MATERIAL	LINER COLOR	CONSTRUCTION	GAUGE	SIZES	PROPS
37-C2110PC-BL	PVC Smooth	One Side	Blue	Cotton Polyester	Natural	Coated Seamless Knit	10	L	▲ ^C
37-C2110PD	PVC Dot	One Side	Black	Cotton Polyester	Natural	Coated Seamless Knit	10	S-L	▲ ^C
37-C2110PDD	PVC Dot	Double-Sided	Black	Cotton Polyester	Natural	Coated Seamless Knit	10	S-L	▲ ^C
37-C500PDD	PVC Dot	Double-Sided	Black	Cotton Polyester	Gray	Coated Seamless Knit	7	S-XL	▲ ^C
37-C512PDD-BL	PVC Dot	Double-Sided	Blue	Cotton Polyester	Natural	Coated Seamless Knit	7	L	
38-1410	Nitrile Smooth	Palm & Fingers	Black	Cotton Polyester	Gray	Coated Seamless Knit	10	S-XL	
38-720	Nitrile Pattern	Double-Sided	Rust	Cotton Polyester	Natural	Coated Seamless Knit	7	S-L	
38-N2110PC	Nitrile Smooth	One Side	Rust	Cotton Polyester	Natural	Coated Seamless Knit	10	S-XL	
39-3013	PVC Pattern	Double-Sided	Orange	Polyester	Orange	Coated Seamless Knit	10	S-XL	
K708SKBSL	PVC Dot	Double-Sided	Black	Cotton Polyester	Natural	Coated Seamless Knit	7	LADIES	

▲ = **WARNING: Cancer** - www.P65Warnings.ca.gov R = **WARNING: Reproductive Harm** - www.P65Warnings.ca.gov C&R = **WARNING: Cancer and Reproductive Harm** - www.P65Warnings.ca.gov



Uncoated String Knits Cotton & Polyester



Scan it

General Assembly / Food Processing
Warehousing / Parts Handling



35-C103
- Economy weight comfortable cotton/polyester fiber
- Complies with FDA food handling requirements 21 CFR, Part 17



BEST SELLER

35-C104
- Standard weight comfortable cotton/polyester fiber
- Complies with FDA food handling requirements 21 CFR, Part 17



35-C119
- Medium weight comfortable cotton/polyester fiber
- Complies with FDA food handling requirements 21 CFR, Part 17



ADDED DEXTERITY

35-C410
- Heavyweight comfortable cotton/polyester fiber
- Complies with FDA food handling requirements 21 CFR, Part 17



35-C500
- Medium weight comfortable cotton/polyester fiber
- Complies with FDA food handling requirements 21 CFR, Part 17



35-C510
- Extra heavy comfortable cotton/polyester fiber
- Complies with FDA food handling requirements 21 CFR, Part 17



35-CB110
- Medium weight comfortable cotton/polyester fiber
- Complies with FDA food handling requirements 21 CFR, Part 17



35-G410
- Heavyweight comfortable cotton/polyester fiber
- Complies with FDA food handling requirements 21 CFR, Part 17

STYLE	COATING	LINER MATERIAL	COLOR	CONSTRUCTION	21 CFR	GAUGE	WEIGHT	SIZES
35-C103	Uncoated	Cotton Polyester	Natural	Seamless Knit	Yes	7	Economy	S-L
35-C104	Uncoated	Cotton Polyester	Natural	Seamless Knit	Yes	7	Standard	XS-L
35-C110	Uncoated	Cotton Polyester	Natural	Seamless Knit	Yes	7	Medium	XS-L
35-C119	Uncoated	Cotton Polyester	Natural	Seamless Knit, Half Finger	Yes	7	Medium	S-L
35-C2110	Uncoated	Cotton Polyester	Natural	Seamless Knit	Yes	10	Medium	S-L
35-C2113	Uncoated	Cotton Polyester	Natural	Seamless Knit	Yes	13	Lightweight	S-L
35-C410	Uncoated	Cotton Polyester	Natural	Seamless Knit	Yes	7	Heavy	S-L
35-C500	Uncoated	Cotton Polyester	Gray	Seamless Knit	Yes	7	Medium	S-XL
35-C510	Uncoated	Cotton Polyester	Natural	Seamless Knit	Yes	7	Extra Heavy	S-L
35-CB110	Uncoated	Cotton Polyester	White	Seamless Knit	Yes	7	Medium	S-L
35-CB604	Uncoated	Cotton Polyester	White	Seamless Knit, Extended Cuff	Yes	7	Extra Heavy	L
35-G410	Uncoated	Cotton Polyester	Gray	Seamless Knit	Yes	7	Heavy	S-L
713SN	Uncoated	Nylon	White	Seamless Knit	-	13	Lightweight	MENS
713SNL	Uncoated	Nylon	White	Seamless Knit	-	13	Lightweight	LADIES



Armor®

Cut-and-Sewn Nitrile Dipped



EXCELLENT
OILY GRIP

General Handling / Parts Handling /
Roofing / Maintenance / Fabrication



Scan it



56-3151

- Medium weight dipped nitrile, jersey liner with smooth finish
- Secure dry grip, protection from puncture and abrasion



56-3152

- Medium weight dipped nitrile, jersey liner with smooth finish
- Secure dry grip, protection from puncture and abrasion



56-3153

- Medium weight dipped nitrile, jersey liner with smooth finish
- Secure dry grip, protection from puncture and abrasion



56-3154

- Medium weight dipped nitrile, jersey liner with smooth finish
- Secure dry grip, protection from puncture and abrasion



56-3170

- Lightweight dipped nitrile, interlock liner with textured finish
- Secure dry, good wet grip, protection from puncture and abrasion



56-3171

- Lightweight dipped nitrile, interlock liner with textured finish
- Secure dry, good wet grip, protection from puncture and abrasion



56-3176

- Lightweight dipped nitrile, interlock liner with textured finish
- Secure dry, good wet grip, protection from puncture and abrasion



56-3180

- Ultra Lightweight dipped nitrile, interlock liner with smooth finish
- Secure dry grip, protection from puncture and abrasion

STYLE	COATING	COATING COVERAGE	COATING COLOR	LINER MATERIAL	CUFF	CONSTRUCTION	WEIGHT	SIZES	PROP 65
56-3145	Nitrile Rough	Palm, Fingers & Knuckles	Blue	Jersey / Terry Cloth	Safety Cuff	Dipped Fabric	Heavyweight	M-XL	-
56-3147	Nitrile Rough	Full Hand	Blue	Jersey / Terry Cloth	Safety Cuff	Dipped Fabric	Heavyweight	L	-
56-3151	Nitrile Smooth	Palm, Fingers & Knuckles	Blue	Jersey	Knit Wrist	Dipped Fabric	Medium Weight	S-XL	⚠️ C&R
56-3152	Nitrile Smooth	Full Hand	Blue	Jersey	Knit Wrist	Dipped Fabric	Medium Weight	S-XL	⚠️ C&R
56-3153	Nitrile Smooth	Palm, Fingers & Knuckles	Blue	Jersey	Safety Cuff	Dipped Fabric	Medium Weight	L	⚠️ C&R
56-3154	Nitrile Smooth	Full Hand	Blue	Jersey	Safety Cuff	Dipped Fabric	Medium Weight	M-XL	⚠️ C&R
1UH7065	Nitrile Smooth	Full Hand	Blue	Jersey	Safety Cuff	Dipped Fabric	Medium Weight	S-XL	-
1UH7063	Nitrile Smooth	Full Hand	Blue	Jersey	Knit Wrist	Dipped Fabric	Medium Weight	M-XL	-
56-3170	Nitrile Textured	Palm, Fingers & Knuckles	Blue	Interlock	Knit Wrist	Dipped Fabric	Lightweight	XS-XL	-
56-3171	Nitrile Textured	Full Hand	Blue	Interlock	Knit Wrist	Dipped Fabric	Lightweight	XS-XL	-
56-3175	Nitrile Textured	Palm, Fingers & Knuckles	Blue	Interlock	3" Safety Cuff	Dipped Fabric	Lightweight	M-XL	-
56-3176	Nitrile Textured	Full Hand	Blue	Interlock	3" Safety Cuff	Dipped Fabric	Lightweight	M-XL	-
56-3180	Nitrile Smooth	Palm, Fingers & Knuckles	Green	Interlock	Knit Wrist	Dipped Fabric	Ultra Lightweight	S-XL	⚠️ C&R

C = ⚠️ **WARNING:** Cancer - www.P65Warnings.ca.gov R = ⚠️ **WARNING:** Reproductive Harm - www.P65Warnings.ca.gov C&R = ⚠️ **WARNING:** Cancer and Reproductive Harm - www.P65Warnings.ca.gov



Armor®

Cut-and-Sewn Latex Dipped



**SUPERIOR
WET/DRY GRIP**



Scan it

General Maintenance / Fabrication /
Assembly / Handling Glass, Tile and
Sheet Metal



3001

- Economy weight canvas lined jersey gloves provide a cool, comfortable fit
- Good grip in dry or oily conditions
- Knit wrist



3003

- Economy weight canvas lined jersey gloves provide a cool, comfortable fit
- Good grip in dry or oily conditions
- Plasticized safety cuff



55-3243

- Economy weight canvas lined jersey gloves provide a cool, comfortable fit
- Good grip in dry or oily conditions
- Plasticized safety cuff



55-3271

- Standard weight canvas lined clute cut gloves provide a cool, comfortable fit
- Good grip in dry or oily conditions
- Knit wrist



55-3273

- Standard weight canvas lined clute cut gloves provide a cool, comfortable fit
- Good grip in dry or oily conditions
- Plasticized safety cuff



59-2515

- Textured vinyl coating provides good grip
- Better dexterity than leather
- Jersey lined for comfort

LATEX COATING PROVIDES SUPERIOR GRIP IN WET/DRY CONDITIONS

Armor® Latex Dipped Fabric

STYLE	COATING	COATING COVERAGE	COATING COLOR	LINER MATERIAL	CUFF	CONSTRUCTION	WEIGHT	SIZES
3001	Latex Crinkle	Palm, Fingers & Knuckles	Yellow	Jersey	Knit Wrist	Dipped Fabric	Economy Weight	L
3003	Latex Crinkle	Palm, Fingers & Knuckles	Yellow	Canvas	Safety Cuff	Dipped Fabric	Economy Weight	L
55-3243	Latex Crinkle	Palm, Fingers & Knuckles	Yellow	Canvas	Safety Cuff	Dipped Fabric	Economy Weight	MENS
55-3271	Latex Crinkle	Palm, Fingers & Knuckles	Yellow	Canvas	Knit Wrist	Dipped Fabric	Standard Weight	MENS
55-3273	Latex Crinkle	Palm, Fingers & Knuckles	Yellow	Canvas	Safety Cuff	Dipped Fabric	Standard Weight	MENS
Dipped Fabric & Clute Cut								
STYLE	COATING	COATING COVERAGE	COATING COLOR	LINER MATERIAL	CUFF	CONSTRUCTION	WEIGHT	SIZES
59-2515	Vinyl Textured	Full Hand	Yellow	Interlock	Slip-On	Cut and Sewn		S-XL



Multi-Purpose Canvas Gloves

General Applications /
Light Protection



Scan it



91-908PDI

- Lightweight 8 oz. economy grade cotton canvas glove with PVC dot on palm, thumb and forefinger



91-910PDO

- Medium weight 10 oz. economy grade cotton canvas glove with PVC dot on palm, thumb and forefinger

BEST SELLER



90-908

- Natural cotton canvas keeps hands cool and protected - PVC dot grip on palm, thumb and forefinger

BEST SELLER



90-908I

- Lightweight 8 oz. multi-purpose fabric glove with a comfortable roomy fit - Straight thumb ideal for close-fisted work



90-910I

- Economy grade 10 oz. ideal for general applications - Knit wrist prevents dirt and debris from entered the glove



92-918

- Double palm provides additional weight, durability and protection



92-918PCG

- Nap-in finish offers greater durability due to its higher abrasion resistance

HI-VISIBILITY

General purpose protection at an affordable price

Clute Cut Dotted Canvas

STYLE	FABRIC	FABRIC COLOR	DOT COLOR	THUMB	CUFF	CONSTRUCTION	FABRIC WEIGHT	SIZES
91-908PDI	Black	Canvas	Natural	Straight	Knit Wrist	Clute Cut	8 oz	MENS
91-910PDI	Black	Canvas	Natural	Straight	Knit Wrist	Clute Cut	10 oz	MENS
91-910PDO	Orange	Canvas	Natural	Straight	Knit Wrist	Clute Cut	10 oz	MENS

Uncoated Clute Cut Fabric - Canvas Single Palm

STYLE	FABRIC	COLOR	PALM	THUMB	CUFF	CONSTRUCTION	FABRIC WEIGHT	SIZES
708R	Canvas Cotton Polyester	Natural	Single	Straight	Knit Wrist	Clute Cut	8 oz	MENS
710K	Canvas Cotton Polyester	Natural	Single	Straight	Knit Wrist	Clute Cut	10 oz	MENS
90-908	Canvas	Natural	Single	Straight	Knit Wrist	Clute Cut	8 oz	MENS
90-908I	Canvas	Natural	Single	Straight	Knit Wrist	Clute Cut	8 oz	MENS
90-910I	Canvas	Natural	Single	Straight	Knit Wrist	Clute Cut	10 oz	MENS
K82SCNCGRI	Cotton	Hi-Vis Green	Single	Straight	Knit Wrist	Clute Cut	Economy Weight	L

Canvas Double Palm

STYLE	FABRIC	COLOR	PALM	THUMB	CUFF	CONSTRUCTION	FABRIC WEIGHT	SIZES
790NIR	Canvas - Nap In	Natural	Double	Straight	Knit Wrist	Clute Cut	Medium Weight	L
92-918	Canvas - Nap In	Natural	Double	Straight	Knit Wrist	Clute Cut	18 oz	MENS
92-918BT	Canvas - Nap In	Natural	Double	Straight	Band Top	Clute Cut	18 oz	MENS
92-918PCG	Cotton / Polyester - Nap In	Hi-Vis Green	Double	Straight	Knit Wrist	Clute Cut	18 oz	MENS
K81SCNCI	Canvas - Nap In	Natural	Double	Straight	Knit Wrist	Clute Cut	Medium Weight	L
K81SCNI	Cotton / Polyester - Nap In	Natural	Double	Straight	Knit Wrist	Clute Cut	Medium Weight	L
K81SPNJRI	Canvas - Nap In	Natural	Double	Straight	Knit Wrist	Clute Cut	Medium Weight	L



Fabric Work Gloves

General Chores / Light Protection /
Farming / Warehousing / Parts Handling



Scan it



93-548
- Cotton construction keeps hands cool and protected
- Nap-out finish offers moderate heat resistance



FM18KWK
- Double palm provides additional weight, durability and protection
- Nap-out finish offers moderate heat resistance



95-606
- Polyester/cotton construction is breathable and decreases hand fatigue



95-806
- Knit wrist helps prevent dirt and debris from entering the glove



BEST SELLER

95-806C
- Clute cut provides a roomy fit
- Straight thumb increases comfort in closed-fisted work



95-808C
- Clute cut provides a roomy fit
- Knit wrist helps prevent dirt and debris from entering the glove



KBJ9I
- Cotton construction keeps hands cool and protected
- Clute cut provides a roomy fit



95-864
- Gunn cut pattern delivers excellent durability, wear and comfort, especially for heavier gloves

Chore Gloves

STYLE	FABRIC	COLOR	PALM	THUMB	CUFF	CONSTRUCTION	FABRIC WEIGHT	SIZES
93-548	Cotton - Nap Out	Green	Double	Straight	Knit Wrist	Clute Cut	Heavyweight	MENS
FM18KWK	Cotton / Polyester - Nap Out	Yellow	Single	Straight	Knit Wrist	Clute Cut	Medium Weight	L
KG22SI	Cotton - Nap Out	Green	Single	Straight	Knit Wrist	Clute Cut	Heavyweight	MENS
M18BT	Cotton - Nap Out	Natural	Single	Straight	Band Top	Clute Cut	Medium Weight	L

Jersey Gloves

STYLE	FABRIC	COLOR	THUMB	CUFF	CONSTRUCTION	FABRIC WEIGHT	SIZES
750C	Cotton	Brown	Straight	Knit Wrist	Clute Cut	Regular Weight	MENS
750LC	Cotton	Brown	Straight	Knit Wrist	Clute Cut	Regular Weight	LADIES
95-606	Cotton / Polyester	Natural	Straight	Knit Wrist	Two-Piece	Medium Weight	MENS
95-606C	Cotton / Polyester	Natural	Straight	Knit Wrist	Two-Piece	Medium Weight	MENS
95-806	Cotton / Polyester	Brown	Straight	Knit Wrist	Clute Cut	Economy Weight	MENS-XL
95-806C	Cotton / Polyester	Brown	Straight	Knit Wrist	Clute Cut	Economy Weight	LADIES
95-808	Cotton / Polyester	Brown	Straight	Knit Wrist	Clute Cut	Regular Weight	MENS
95-808C	Cotton / Polyester	Brown	Straight	Knit Wrist	Clute Cut	Regular Weight	LADIES
95-864	Cotton / Polyester	Brown	Straight	Slip-on	Clute Cut	Heavyweight	MENS
KBJ9I	Cotton	Brown	Straight	Knit Wrist	Clute Cut	Heavyweight	MENS
KBJ9LI	Cotton	Brown	Straight	Knit Wrist	Clute Cut	Heavyweight	LADIES
KJ55I	Cotton	Natural	Straight	Knit Wrist	Clute Cut	Lightweight	MENS
KJ8I	Cotton	Natural	Straight	Knit Wrist	Clute Cut	Lightweight	MENS
KJ8LI	Cotton	Natural	Straight	Knit Wrist	Clute Cut	Lightweight	LADIES



Fabric Hot Mill Gloves



Automotive / Foundries / Heat Treating /
Textiles / Power Generation

Scan it



94-924

- Premium grade, medium weight two-layered cotton canvas construction



94-928G

- Premium grade, medium weight three-layered cotton canvas construction



94-928I

- Economy grade, medium weight three-layered cotton canvas construction



94-932

- Premium grade, heavyweight three-layered cotton canvas construction

BEST SELLER



94-932G

- Premium grade, heavyweight three-layered cotton canvas construction



94-934

- Premium grade, heavyweight three-layered cotton canvas construction

DENIM PALM

STYLE	WEIGHT	COLOR	LAYERS	CUFF	BURLAP	SIZES
1JC3016W	16 oz	Natural	Two	Band Top	No	L
94-924	24 oz	Natural	Two	Band Top	No	MENS
94-924G	24 oz	Natural	Two	Starched Gauntlet	No	MENS
94-924I	24 oz	Natural	Two	Band Top	No	MENS
94-924R	24 oz	Natural	Two	Band Top	No	MENS
94-928	28 oz	Natural	Three	Band Top	Yes	MENS
94-928G	28 oz	Natural	Three	Starched Gauntlet	Yes	MENS
94-928I	28 oz	Natural	Three	Band Top	Yes	MENS
94-930	30 oz	Natural	Three	Band Top	No	MENS
94-932	32 oz	Natural	Three	Band Top	Yes	MENS
94-932G	32 oz	Natural	Three	Starched Gauntlet	Yes	MENS
94-934	34 oz	Natural/Denim	Three	Band Top	No	MENS



Terry Cloth Gloves



Scan it

Automotive / Appliance
Manufacturing / HVAC /
Metal Stamping / Bakeries
and Ceramic Plants



BEST SELLER

42-C700

- 24 oz. heavyweight terry glove provides resistance to abrasions and heat
- Loop out design helps protect against intermittent contact with hot surfaces



CUT RESISTANT

ANSI



MTATA/GYC-CC

- 24 oz. heavyweight ATA terry glove provides resistance to cut, abrasion and heat
- Hide-Away™ fibers hide dirt and grime



42-C713

- 18 oz. medium weight terry glove provides resistance to abrasion and heat
- Loop out design provides improved cut resistance, oil absorption and glove life



42-C750

- 24 oz. heavyweight terry glove provides resistance to abrasion and heat
- Knit wrist helps prevent dirt and debris from entering the glove



42-C753

- 18 oz. medium weight terry glove provides resistance to abrasion and heat
- Ambidextrous, permits glove to be worn on either hand, extending wear and reducing cost

**PROTECTS AGAINST
INTERMITTENT
CONTACT WITH
HOT SURFACES**

STYLE	ANSI CUT	WEIGHT	COLOR	CUFF	SIZES
42-C700	-	24 oz	Natural	Knit Wrist	S-L
42-C713	-	18 oz	Natural	Knit Wrist	S-L
42-C750	-	24 oz	Gray	Knit Wrist	L
42-C753	-	18 oz	Gray	Knit Wrist	S-L
MTATA/GYC-CC	A4	24 oz	Gray	Knit Wrist	S-XL

*More terry cloth gloves, sleeves and pads available online



Pattern Grip Hot Mill Gloves



Scan it

Float Glass / Foundries & Metal Casting /
Ceramics Manufacturing / Forging Operations



100% COTTON



EVERGRIP™ NITRILE



SILICONE COATING



43-500 | 43-502

- 100% cotton double-layer seamless construction offers increased comfort, breathability and heat protection
- Dual-layered for two layers of heat protection
- Ambidextrous pattern permits glove to be worn on either hand, extending wear and reducing costs
- Open cuff allows for easy on and off

ANSI

A4

43-851 | 43-858

- Kevlar®/Preox blend shell provides excellent cut, abrasion and thermal protection as well as flame resistance
- Ambidextrous pattern permits glove to be worn on either hand, extending wear and reducing costs
- Meets OSHA CFR 1910.269 standards
- Protects against the intense heat of an electric ARC complying with NFPA 70E standards

STYLE	WEIGHT	COATING	COATING COVERAGE	COATING COLOR	LINER MATERIAL	LINER COLOR	CONSTRUCTION	CUFF	SIZES
43-500	24 oz	Uncoated	Uncoated	-	100% Cotton	Natural	Coated Double-Layered Seamless Knit	Open	XS-L
43-502	24 oz	EverGrip™ Nitrile	Single-Sided	Rust	100% Cotton	Natural	Coated Double-Layered Seamless Knit	Open	S-L
43-552	24 oz	EverGrip™ Nitrile	Single-Sided	Rust	Kevlar®/Cotton Blend	Yellow	Coated Double-Layered Seamless Knit	Open	S-L
43-851	32 oz	Silicone	Double-Sided	Black	Kevlar®/Preox Blend, Terry Cotton Lined	Green	Coated Double-Layered Seamless Knit	Open	L
43-858	32 oz	Uncoated	Uncoated	-	Kevlar®/Preox Blend, Terry Cotton Lined	Green	Coated Double-Layered Seamless Knit	Open	S-L



Insulated Coated Seamless Knit



Scan it

Construction /
Transportation / Railyard /
Mining / Warehousing /
Cold Storage / Oil & Gas



ANSI
A5

41-8035
- Single-layer construction provides excellent dexterity
- Full hand coverage keeps hands warm and dry



ANSI
A4

41-8014
- Single-layer construction provides excellent dexterity
- Coating provides excellent abrasion resistance and a good grip in dry and slightly oily conditions



ANSI
A2

41-7322
- Double-layered 13-gauge nylon shell with a 7-gauge acrylic terry liner
- PVC foam is water-resistant and flexible in extremely cold conditions



ANSI
A3

41-1415
- Hi-vis wrist for added visibility in poor conditions
- Double-dipped full hand coating provides liquid protection



ANSI
A4

41-1417
- 15-gauge PolyKor® shell with 7-gauge acrylic lining provides thermal insulation
- Double-dipped full hand coating provides liquid protection



ANSI
A3

16-820
- Extended coating coverage to knuckle for added abrasion resistance
- Coating provides a good grip in dry, wet, or oily conditions



ANSI
A3

09-K1350
- Resistant to light heat and spark
- Coating provides excellent abrasion resistance and grip in dry and slightly oily conditions



58-7305

- Smooth tacky coating provides a good grip in dry and slightly wet conditions
- Foam insulation keeps hands warm and dry



58-8658DL

- Sandy coating finish provides a good grip in wet conditions
- Detachable 7-gauge orange terry cloth liner for slightly oily conditions

Insulated Coated Seamless Knit Cut

STYLE	ANSI CUT	EN388	COATING	COATING COVERAGE	COATING COLOR	LINER	LINER COLOR	CONSTRUCTION	GAUGE	SIZES	PROP 65
41-8035	A5	3X42E	Latex MicroSurface	Full Hand	Black/Blue	Acrylic PolyKor™	Salt & Pepper	Coated Seamless Knit	10	S-2XL	-
41-8014	A4	3X42D	Latex MicroSurface	Palm & Fingers	Black/Blue	Acrylic PolyKor™	Blue	Coated Seamless Knit	10	S-2XL	-
41-7322	A2	4X41B	PVC Foam	Palm, Fingers & Knuckles	Black	Acrylic PolyKor™	Black	Coated Seamless Knit	13	L-2XL	-
41-1415	A3	4432CX	Nitrile Foam	Palm, Full Finger & Knuckle	Black/Blue	Acrylic PolyKor™	Hi-Vis Yellow	Coated Seamless Knit	15	S-2XL	-
41-1417	A4	4X32D	Nitrile Foam	Palm, Full Finger & Knuckle	Black/Blue	Acrylic PolyKor™	Black	Coated Seamless Knit	15	S-2XL	-
16-820	A3	3X43CX	Latex MicroSurface	Palm, Fingers & Knuckles	Black	Acrylic PolyKor™	Salt & Pepper	Coated Seamless Knit	13	S-2XL	-
09-K1350	A3	2342CX	Latex MicroFinish	Palm & Fingers	Brown	Kevlar® / Acrylic	Yellow	Coated Seamless Knit	10	S-2XL	-

ProCoat™ Insulated Coated PVC

STYLE	ANSI CUT	EN388	POLYMER	COLOR	CUFF	LENGTH	GRIP	CONSTRUCTION	LINING	SIZES	
58-7305	-	4121XX	PVC	Hi-Vis Orange	Safety	11"	Supported	Smooth	Foam	MENS	⚠️ C
58-8658DL	-	4121X	PVC	Blue	Straight	12"	Supported	Rough	Terry	L-2XL	-

C = ⚠️ **WARNING:** Cancer - www.P65Warnings.ca.gov R = ⚠️ **WARNING:** Reproductive Harm - www.P65Warnings.ca.gov C&R = ⚠️ **WARNING:** Cancer and Reproductive Harm - www.P65Warnings.ca.gov



32L710

- Hi-vis liner for added visibility in poor conditions
- Crinkle coating provides a secure grip in dry or wet conditions



BEST SELLER

41-1400

- Terry liner provides excellent thermal insulation
- Coating provides a good grip in dry, wet, or oily conditions



41-1405

- Terry liner provides excellent thermal insulation
- Coating provides a good grip in dry, wet, or oily conditions



41-1420

- Heavy gauge terry liner for added thermal protection
- Ideal for transportation and snow clearing applications where visibility is required



YOUR LOGO HERE

41-1425

- Hi-vis liner for added visibility in poor conditions
- Soft and comfortable, quickly evaporates moisture from the skin



41-1430

- Acrylic liner provides an economical alternative for cold weather applications
- Coating provides a good grip in dry, wet, or oily conditions



EXTRA COATING

41-1475

- Extended coating coverage to knuckle for added abrasion resistance
- Coating provides a good grip in dry, wet, or oily conditions



NEW

715SBWRND

- Lightweight liner for tasks that require a high degree of dexterity
- Coating provides a good grip in dry, wet, or oily conditions

Keep working hands warm and dry

PROVIDES EXCEPTIONAL
BALANCE BETWEEN PERFORMANCE AND
COLD WEATHER PROTECTION

Insulated Coated Seamless Knit GP

STYLE	EN388	COATING	COATING COVERAGE	COATING COLOR	LINER	LINER COLOR	CONSTRUCTION	GAUGE	SIZES
32L710	1121X	Latex Crinkle	Palm & Fingers	Blue	Acrylic	Hi-Vis Yellow	Coated Seamless Knit	10	M-XL
41-1400	2231XX	Latex MicroFinish	Palm & Fingers	Brown	Acrylic	Hi-Vis Orange	Coated Seamless Knit	10	S-2XL
41-1405	1231XX	Latex MicroFinish	Palm & Fingers	Brown	Acrylic	Hi-Vis Yellow	Coated Seamless Knit	10	S-2XL
41-1420	1221XX	Latex Crinkle	Palm & Fingers	Black	Acrylic	Hi-Vis Yellow	Coated Seamless Knit	7	S-XL
41-1425	3132XX	Latex Crinkle	Palm & Fingers	Black	Acrylic	Hi-Vis Yellow	Coated Seamless Knit	10	S-2XL
41-1430	3231XX	Latex MicroFinish	Palm & Fingers	Brown	Polyester / Acrylic	Black	Coated Seamless Knit	10	S-2XL
41-1475	2121XX	Latex MicroFinish	Palm, Fingers & Knuckles	Brown	Acrylic	Hi-Vis Orange	Coated Seamless Knit	10	S-2XL
715SBWRND	-	Nitrile Sandy	Palm, Fingers & Knuckles	Black	Acrylic	Black	Seamless Knit	15	S-2XL



Scan it

Seamless Knit Gloves and Liners



BEST SELLER

41-001



41-001NB



41-001W

THERMAX® GLOVES

- Thermax® helps wick moisture away from the hands, keeping them warm, dry and comfortable
- Lightweight, extra-soft material ideal for use as a non-chafing glove liner



41-005

- Polypropylene liner quickly evaporates moisture from the skin
- Lightweight, extra-soft material ideal for use as a non-chafing glove liner



41-070

- Ragwool blend provides warmth, durability and wind resistance
- Economical heavy gauge seamless construction for use as a glove or glove liner



41-130

- Merino® wool provides superior insulating properties even when wet
- Lightweight, extra-soft non-chafing glove liner

IDEAL AS INSULATING GLOVE LINERS

STYLE	MATERIAL	COLOR	GUAGE	WEIGHT	SIZES
41-001	Thermax®	Black	13	Light	M-L
41-001NB	Thermax®	Blue	13	Light	L
41-001W	Thermax®	White	13	Light	L
41-005	Polypropylene	Dark Blue	13	Light	XS-XL
41-010	100% Acrylic	Natural	7	Medium	XS-XL
41-011	100% Acrylic	Black	7	Medium	S-XL
41-013	100% Acrylic	Hi-Vis Orange	7	Medium	XS-XL
41-070	75% Wool, 25% Nylon	Natural	7	Medium	S-XL
41-130	Merino Wool	Black	13	Light	L



Insulated Leather Palm

Construction / Transportation / Aviation /
Shipping & Freight / Heavy-Duty Industrial



Scan it



5558P
- Durable split cowhide leather palm with white thermal lining

BEST SELLER



120-4800
- PVC diamond grip on fingers and palm for an enhanced grip
- Neoprene pad offers added protection on the knuckles



1555
- Breathable pigskin leather palm with Posi-Therm™ lining
- Leather knuckle strap and finger tips for extra protection



5555
- Breathable pigskin leather palm with Posi-Therm™ lining
- Leather knuckle strap and finger tips for extra protection

BEST SELLER



HVY1555
- Top grain leather is smooth, provides durability and dexterity
- Hi-vis liner for added visibility in poor conditions



HVY5555
- Posi-Therm™ lining provides excellent insulation without the bulk of fleece
- Wing thumb increases comfort in open-handed work



96652
- Synthetic leather palm provides good grip in dry and light oil conditions
- Neoprene padded knuckles for added protection

BEST SELLER



96653
- Synthetic leather palm provides good grip in dry and light oil conditions
- Lining is waterproof, windproof and breathable

PADDED KNUCKLES

Insulated Leather Palm Gloves

STYLE	HIDE	GRADE	INSULATION	PATTERN	THUMB	BACK	COLOR	CUFF	SIZES	PROP 65
5558P	Cowhide	Regular	Posi-Therm™	Gunn	Wing	Canvas	Blue/Black/Red	Safety, Rubberized	L-2XL	-
78-7863B	Cowhide	Regular	Fleece Pile	Gunn	Wing	Canvas	Blue/Yellow	Safety, Rubberized	L-XL	-
120-4800	Goatskin	Premium	3M™ Thinsulate™	-	Wing	Spandex	Black/Gold	Knit Wrist	M-2XL	⚠️ C&R
1555	Pigskin	Premium	Posi-Therm™	Gunn	Wing	Canvas	Blue/Black/Red	Knit Wrist	M-XL	-
5555	Pigskin	Premium	Posi-Therm™	Gunn	Wing	Canvas	Blue/Black/Red	Safety, Rubberized	M-2XL	-
78-3927	Pigskin	Premium	3M™ Thinsulate™	Gunn	Straight	Canvas	Blue/Green	Safety, Rubberized	M-XL	-
HV01555	Pigskin	Premium	Posi-Therm™	Gunn	Wing	Nylon	Hi-Vis Orange	Knit Wrist	S-XL	⚠️ C&R
HVY1555	Pigskin	Premium	Posi-Therm™	Gunn	Wing	Nylon	Hi-Vis Yellow	Knit Wrist	M-2XL	-
HVY5555	Pigskin	Premium	Posi-Therm™	Gunn	Wing	Nylon	Hi-Vis Yellow	Safety, Rubberized	M-2XL	-
120-4070	Synthetic	-	3M™ Thinsulate™	-	Wing	Spandex	Hi-Vis Yellow/Black	Slip-On	M-XL	-
96551	Synthetic	-	Posi-Therm™	-	Wing	Spandex	Hi-Vis Yellow/Black	Slip-On	S-2XL	-
96652	Synthetic	-	Fleece	-	Wing	Spandex	Hi-Vis Yellow/Black	Hook & Loop Closure	S-2XL	-
96653	Synthetic	-	Fleece	-	Wing	Spandex	Yellow/Black	Hook & Loop Closure	S-2XL	-

C = ⚠️ **WARNING:** Cancer - www.P65Warnings.ca.gov

R = ⚠️ **WARNING:** Reproductive Harm - www.P65Warnings.ca.gov

C&R = ⚠️ **WARNING:** Cancer and Reproductive Harm - www.P65Warnings.ca.gov



Insulated Leather Drivers



Scan it

Construction / Farm &
Ranch / Transportation /
Equipment Operation



999

- White thermal liner provides excellent insulation
- Straight thumb for increased comfort in close-fisted work



77-268

- Red thermal lining is a dense, heavy fabric that provides excellent insulation
- Keystone thumb is ergonomic for improved dexterity

BEST SELLER



77-269

- 3M™ Thinsulate™ provides superior insulation without the bulk of fleece
- Keystone thumb is ergonomic for improved dexterity



77-289TL

- 3M™ Thinsulate™ provides superior insulation without the bulk of fleece
- Keystone thumb is ergonomic for improved dexterity



9920KT

- Top grain deerskin leather provides highest insulation protection from cold weather
- Keystone thumb is ergonomic for improved dexterity



77-418

- White thermal liner provides excellent insulation
- Straight thumb for increased comfort in close-fisted work



994KP

- White thermal lining provides superior lightweight insulation
- Keystone thumb is ergonomic for improved dexterity

BEST SELLER



750RKW

- Heavyweight comfortable cotton/polyester fiber
- Complies with FDA food handling requirements 21 CFR, Part 17

Insulated Leather Drivers

STYLE	HIDE	GRADE	INSULATION	THUMB	COLOR	CUFF	SIZES	PROP 65
999	Cowhide	Premium	White Thermal	Straight	Natural	Slip-On	S-XL	-
77-208	Cowhide	Premium	Red Foam	Straight	Natural	Slip-On	S-XL	-
77-265	Cowhide	Premium	White Thermal	Keystone	Natural	Slip-On	S-XL	-
77-268	Cowhide	Premium	Red Thermal	Keystone	Natural	Slip-On	S-XL	-
77-269	Cowhide	Premium	3M™ Thinsulate™	Keystone	Natural	Slip-On	S-XL	⚠️ C&R
999KP	Cowhide	Premium	Posi-Therm™	Keystone	Natural	Slip-On	S-XL	-
77-289TL	Cowhide	Regular	3M™ Thinsulate™	Keystone	Natural	Slip-On	S-2XL	-
77-3600	Goatskin	Premium	White Thermal	Keystone	White	Slip-On	S-XL	-
9920KT	Deerskin	Premium	Posi-Therm™	Keystone	Natural	Slip-On	M-XL	-
77-418	Pigskin	Premium	White Thermal	Straight	Natural	Slip-On	S-XL	⚠️ C&R
77-468	Pigskin	Premium	Red Thermal	Keystone	Natural	Slip-On	S-XL	⚠️ C&R
77-469	Pigskin	Premium	3M™ Thinsulate™	Keystone	Natural	Slip-On	S-XL	⚠️ C&R
994KF	Pigskin	Regular	Red Fleece	Keystone	Natural	Slip-On	S-3XL	-
994KOTP	Pigskin	Regular	Posi-Therm™	Keystone	Natural/Hi-Vis Orange Tips	Slip-On	S-2XL	-
994KP	Pigskin	Premium	Posi-Therm™	Keystone	Natural	Slip-On	S-3XL	-

Insulated Uncoated Gloves

STYLE	MATERIAL	COLOR	CUFF	SIZES
750RKW	Cotton / Polyester	Brown	Knit Wrist	L-XL
755C	Cotton / Polyester	Brown	Slip-on	MENS

C= ⚠️ WARNING: Cancer - www.P65Warnings.ca.gov

R= ⚠️ WARNING: Reproductive Harm - www.P65Warnings.ca.gov

C&R= ⚠️ WARNING: Cancer and Reproductive Harm - www.P65Warnings.ca.gov



Top Grain Leather Drivers



Scan it

Equipment Operation / Utility Work / Farming /
General Applications / Roping / Construction



ANSI
A4



9110

- Kevlar® stitching provides added durability
- Supple sheepskin provides broken in feel



BEST SELLER



9920K

- Deerskin leather provides the highest cold weather insulation and provides the highest durability and flexibility



BEST SELLER



71-3600

- Goatskin leather is the most abrasion resistant leather
- Keystone thumb is ergonomic, providing better dexterity



BEST SELLER



994K

- Pigskin leather becomes softer with use and withstands moisture without stiffening
- Keystone thumb is ergonomic, providing better dexterity



BEST SELLER



69-189

- Split leather provides good abrasion resistance
- Keystone thumb is ergonomic, providing better dexterity

Top Grain Leather Drivers

STYLE	ANSI CUT	HIDE	GRADE	THUMB	CUFF	CLOSURE	STITCHING	SIZES
9110	A4	Sheepskin	Economy	Keystone	Slip-On	-	Kevlar®	S-3XL
9920K	-	Deerskin	Premium	Keystone	Slip-on	Elastic	Nylon	XS-2XL
71-3618	-	Goatskin	Premium	Keystone	Slip-on	Elastic	Nylon	S-XL
71-3600	-	Goatskin	Industry	Keystone	Slip-on	Elastic	Nylon	S-2XL
70-368	-	Pigskin / Hi-Vis Orange Tips	Premium	Keystone	Slip-on	Elastic	Nylon	S-XL
9940K	-	Pigskin	Premium	Keystone	Slip-on	Elastic	Nylon	S-XL
994K	-	Pigskin	Regular	Keystone	Slip-on	Elastic	Nylon	S-2XL
70-361	-	Pigskin	Economy	Keystone	Slip-on	Elastic	Nylon	S-XL
70-360	-	Pigskin	Industry	Keystone	Slip-on	Elastic	Nylon	S-3XL
994	-	Pigskin	Regular	Straight	Slip-on	Elastic	Nylon	S-2XL
70-301	-	Pigskin	Economy	Straight	Slip-on	Elastic	Nylon	S-XL
70-300	-	Pigskin	Industry	Straight	Slip-on	Elastic	Nylon	S-XL
Split Leather Drivers								
69-189	-	Cowhide	Premium	Keystone	Slip-on	Elastic	Nylon	S-XL
69-138	-	Cowhide	Regular	Straight	Slip-on	Elastic	Nylon	S-XL
9405	-	Cowhide	Premium	Keystone	Slip-on	Elastic	Nylon	S-3XL



68-165

- Cowhide leather construction provides comfort, durability, excellent abrasion resistance and breathability



997KB

- Hi-vis TPR molded knuckle and dorsal guards provide protection from impact and pinch
- Ergonomic keystone thumb offers superior dexterity and durability



68-163SB

- Kevlar[®] stitching provides strength and heat resistance
- Economical regular grade top grain cowhide with shoulder split leather back provides durability and dexterity



68-161SB

- Economical regular grade shoulder split cowhide with keystone thumb is smooth, provides durability and dexterity



BEST SELLER

68-163

- Economical regular grade top grain cowhide with keystone thumb is smooth, provides durability and dexterity



68-101

- Cowhide leather construction provides comfort, durability, excellent abrasion resistance and breathability



9901

- Cowhide leather construction provides comfort, durability, excellent abrasion resistance and breathability



68-103

- Economical regular grade top grain cowhide with straight thumb is comfortable, provides durability and dexterity



68-162SB

- Kevlar[®] stitching provides strength and heat resistance
- Wing thumb increases comfort in open-handed work



Top Grain Leather Drivers

STYLE	HIDE	GRADE	THUMB	CUFF	CLOSURE	STITCHING	SIZES
68-165	Cowhide	Superior	Keystone	Slip-on	Elastic	Nylon	S-XL
68-165HV	Cowhide / Hi-Vis Orange Tips	Superior	Keystone	Slip-on	Elastic	Nylon	XS-2XL
68-168	Cowhide	Premium	Keystone	Slip-on	Elastic	Nylon	S-XL
997KB	Cowhide / Split Leather Back	Premium	Keystone	Slip-on	Elastic	Nylon	XS-3XL
997KBC	Cowhide / Split Leather Back	Premium	Keystone	Slip-on	Elastic	Nylon	S-3XL
HV0990K	Cowhide / Hi-Vis Orange Fabric Back	Premium	Keystone	Slip-on	Elastic	Nylon	S-XL
9901K	Cowhide	Premium	Keystone	Slip-on	Elastic	Nylon	M-5XL
993K	Cowhide / Split Leather Back	Premium	Keystone	Slip-on	Elastic	Aramid	S-2XL
68-163SB	Cowhide / Split Leather Back	Regular	Keystone	Slip-on	Elastic	Kevlar [®]	S-XL
68-161SB	Cowhide / Split Leather Back	Regular	Keystone	Slip-on	Elastic	Nylon	S-XL
68-163	Cowhide	Regular	Keystone	Slip-on	Elastic	Nylon	XS-3XL
68-163HV	Cowhide / Hi-Vis Orange Tips	Regular	Keystone	Slip-on	Elastic	Nylon	S-2XL
68-162	Cowhide	Economy	Keystone	Slip-on	Elastic	Nylon	S-2XL
68-162HV	Cowhide / Hi-Vis Orange Tips	Economy	Keystone	Slip-on	Elastic	Nylon	S-2XL
68-160SB	Cowhide / Split Leather Back	Industry	Keystone	Slip-on	Elastic	Nylon	S-2XL
68-101	Cowhide	Superior	Straight	Slip-on	Elastic	Nylon	XS-2XL
68-101G	Cowhide	Superior	Straight	Gauntlet	Elastic	Nylon	L-XL
68-118	Cowhide	Premium	Straight	Slip-on	Elastic	Nylon	S-XL
9901	Cowhide	Premium	Straight	Slip-on	Elastic	Nylon	XS-2XL
68-103	Cowhide	Regular	Straight	Slip-on	Elastic	Nylon	S-2XL
68-153	Cowhide	Regular	Straight	Slip-on	Pull Strap	Nylon	S-XL
68-105	Cowhide	Economy	Straight	Slip-on	Elastic	Nylon	S-2XL
68-106	Cowhide	Industry	Straight	Slip-on	Elastic	Nylon	S-2XL
68-116	Cowhide	Superior	Wing	Slip-on	Elastic	Kevlar [®]	S-XL
68-162SB	Cowhide / Split Leather Back	Regular	Wing	Slip-on	Elastic	Kevlar [®]	S-XL
9420	Cowhide	Premium	Keystone	Slip-on	Elastic	Nylon	S-3XL
9414	Cowhide / Split Leather Back	Premium	Keystone	Slip-on	Elastic	Nylon	S-3XL



Split Leather Palm Gloves



Construction / Metalworking / Farming /
Equipment Operation / Maintenance



Scan it



PREMIUM BEST SELLER



500Y

- Constructed of heavy side-split cowhide
- Heavy-duty canvas back provides superior durability



CUT RESISTANT

ANSI

A5



MJVATA

- Constructed of heavy side-split cowhide
- ATA[®] liner provides excellent cut protection, heat protection and is inherently flame resistant



STITCHED WITH KEVLAR[®]



80-8800

- Constructed of heavy side-split cowhide
- Stitched with Kevlar[®] adding strength and burn resistance



558

- Constructed of Grade A select shoulder-split cowhide
- Excellent quality and affordability

STYLE	ANSI CUT	HIDE	SERIES	GRADE	PATTERN	PALM	BACK	LINER	COLOR	CUFF	STITCHING	SIZES
80-8800	-	Split Cowhide	Platinum	Heavy Side	Gunn	Single	Heavy Canvas	-	White	Safety, Rubberized	Kevlar [®]	S-XL
500Y	-	Split Cowhide	Premium	Premium	Gunn	Single	Heavy Canvas	-	Yellow	Safety, Rubberized	Nylon	S-3XL
558	-	Split Cowhide	Gold	Regular	Gunn	Single	Canvas	-	Blue/Black/Red	Safety, Rubberized	Nylon	M-2XL
81-7563YB	-	Split Cowhide	Gold	A Select Shoulder	Gunn	Single	Heavy Canvas	-	Gold	Safety, Rubberized	Nylon	MENS
82-7563	-	Split Cowhide	Silver	A/B Select Shoulder	Gunn	Single	Canvas	-	Blue/Green	Safety, Rubberized	Nylon	S-XL
82-7583	-	Split Cowhide	Silver	A/B Select Shoulder	Gunn	Single	White	-	White	Safety, Rubberized	Nylon	S-XL
83-6563	-	Split Cowhide	Bronze	B Shoulder	Gunn	Single	Canvas	-	Green/Pink	Safety, Rubberized	Nylon	XS-2XL
84-6532	-	Split Cowhide	Copper	B/C Shoulder	Gunn	Single	Canvas	-	Green/Pink	Safety, Rubberized	Nylon	S-XL
84-7532	-	Split Cowhide	Copper	B/C Shoulder	Gunn	Single	Canvas	-	Blue/Black/Red	Safety, Rubberized	Nylon	S-2XL
84-7532A	-	Split Cowhide	Copper	B/C Shoulder	Gunn	Single	Canvas	-	Blue/Green	Safety, Launderable	Nylon	XS-XL
85-7512	-	Split Cowhide	Copper	B/C Shoulder	Gunn	Single	Canvas	-	Gray/Red	Safety, Rubberized	Nylon	MENS
85-7512CS	-	Split Cowhide	Copper	B/C Shoulder	Gunn	Single	Canvas	-	Gray/Red	Safety, Starched	Nylon	LADIES
548	-	Split Cowhide	Economy	Regular	Gunn	Single	Canvas	-	Blue/Black/Red	Safety, Rubberized	Nylon	S-2XL
MJVATA	A5	Split Cowhide	Platinum	Premium	Gunn	Single	Canvas	Kut Gard [®] ATA [®] Technology	White	Safety, Rubberized	Kevlar [®]	M-2XL



85-7500
- Constructed of economical split side cowhide
- Fabric back provides breathability and flexibility



IC5
- Heavy-duty canvas back provides superior durability
- Wing thumb increases comfort in open-handed work applications



IC6
- Full leather back for heavy-duty applications
- Gunn cut pattern delivers excellent durability, wear and comfort, especially for heavier gloves



IC8DP
- Double palm offers comfort, insulation and heat protection
- Gauntlet cuff provides additional forearm protection



500DP
- Double palm offers comfort, insulation and heat protection
- Fabric back provides breathability and flexibility



85-7512J
- Constructed of economical split side cowhide
- Double palm offers comfort, insulation and heat protection

GLOVES BUILT FOR RUGGED WORK

STYLE	HIDE	SERIES	GRADE	PATTERN	PALM	BACK	COLOR	CUFF	STITCHING	SIZES
558L	Split Cowhide	Economy	Regular	Gunn	Single	Canvas	Blue/Black/Red	Safety, Rubberized	Nylon	LADIES
85-7500	Split Cowhide	Economy	Economy	Gunn	Single	Canvas	Blue/Black/Red	Safety, Rubberized	Nylon	S-XL
85-7500P	Split Cowhide	Economy	Economy	Gunn	Reinforced	Canvas	Blue/Black/Red	Safety, Starched	Nylon	MENS
85-7500SC	Split Cowhide	Economy	Economy	Gunn	Single	Canvas	Blue/Black/Red	Safety, Starched	Nylon	MENS
85-7513P	Split Cowhide	Economy	Economy	Gunn	Reinforced	Canvas	Yellow	Safety, Rubberized	Nylon	MENS
85-DB7563P	Split Cowhide	Economy	Economy	Gunn	Reinforced	Denim	Blue	Safety, Denim	Nylon	MENS
500-AAA	Split Cowhide	Platinum	Heavy Side	Gunn	Single	Heavy Canvas	Natural	Safety	Aramid	S-XL
IC5	Split Cowhide	Platinum	Heavy Side	Gunn	Single	Heavy Canvas	Blue	Safety, Rubberized	Aramid	S-XL
IC6	Split Cowhide	Platinum	Heavy Side	Gunn	Single	Full Leather	Blue	Safety, Rubberized	Aramid	S-3XL
IC65	Split Cowhide	Platinum	Heavy Side	Gunn	Single	3/4 Leather	Blue	Safety, Rubberized	Aramid	S,M,L,XL,3XL
IC8	Split Cowhide	Platinum	Heavy Side	Gunn	Single	Heavy Canvas	Blue	Safety, Rubberized	Aramid	S-XL
IC9	Split Cowhide	Platinum	Heavy Side	Gunn	Single	Full Leather	Blue	Gauntlet, Rubberized	Aramid	S-XL
IC5DP	Split Cowhide	Platinum	Heavy Side	Gunn	Double	Heavy Canvas	Blue	Safety, Rubberized	Aramid	S-XL
IC8DP	Split Cowhide	Platinum	Heavy Side	Gunn	Double	Heavy Canvas	Blue	Gauntlet, Rubberized	Aramid	L-XL
500DP-AA	Split Cowhide	Platinum	Heavy Side	Gunn	Double	Heavy Canvas	White/Gray	Safety, Rubberized	Aramid	S-XL
80-8855	Split Cowhide	Platinum	Heavy Side	Gunn	Double	Heavy Canvas	White	Safety, Rubberized	Aramid	S-XL
80-8866	Split Cowhide	Platinum	Heavy Side	Gunn	Double	Heavy Canvas	White	Gauntlet, Rubberized	Aramid	XL
450DP	Split Cowhide	Silver	Standard Shoulder	Gunn	Double	Canvas	Green/Pink	Safety, Rubberized	Nylon	L-2XL
500DP	Split Cowhide	Gold	Select Shoulder	Gunn	Double	Canvas	Green/Pink	Safety, Rubberized	Nylon	S-XL
82-7563ID	Split Cowhide	Silver	A/B Select Shoulder	Gunn	Double	Canvas	Blue/Green	Safety, Rubberized	Nylon	L
82-7763	Split Cowhide	Silver	A/B Select Shoulder	Gunn	Double	Canvas	Blue/Green	Safety, Rubberized	Nylon	S-XL
83-6733	Split Cowhide	Bronze	B Shoulder	Gunn	Double	Canvas	Green/Pink	Safety, Rubberized	Nylon	MENS
83-6763	Split Cowhide	Bronze	B Shoulder	Gunn	Double	Canvas	Green/Pink	Gauntlet, Rubberized	Nylon	MENS
84-7533J	Split Cowhide	Bronze	B/C Shoulder	Gunn	Double	Canvas	Blue, Black, Red	Safety, Rubberized	Nylon	MENS
84-7533	Split Cowhide	Copper	B/C Shoulder	Gunn	Double	Canvas	Blue, Black, Red	Safety, Rubberized	Nylon	MENS
84-7633	Split Cowhide	Copper	B/C Shoulder	Gunn	Double	Canvas	Blue, Black, Red	Safety, Rubberized	Nylon	MENS
85-7512J	Split Cowhide	Economy	B/C Shoulder	Gunn	Double	Canvas	Gray/Red	Safety, Rubberized	Nylon	S-XL
1JL2393	Split Cowhide	Economy	B/C Shoulder	Gunn	Double	Canvas	Gray/Orange	Safety, Rubberized	Aramid	S-3XL



Top Grain Leather Palm



Scan it

Heavy-Duty Material Handling / Construction /
General Maintenance / Farming



5000

- Cowhide leather construction provides comfort and dexterity
- Wing thumb increases comfort in open-handed work

PREMIUM BEST SELLER



8000

- Cowhide leather construction provides comfort and dexterity
- Gauntlet cuff provides additional forearm protection



87-2066

- Rugged full leather back for heavy-duty protection
- Cotton lined palm for extra comfort

STITCHED WITH KEVLAR



87-1563P

- Cowhide leather construction provides comfort and dexterity

REINFORCED PALM



5150

- Economical cowhide leather palm with fabric back provides durability, abrasion resistance and breathability



87-1663

- Economical cowhide leather palm with fabric back provides durability, abrasion resistance and breathability

ADDED FOREARM PROTECTION



87-3563

- Pigskin leather provides great breathability due to its porous texture
- Becomes softer with use and withstands moisture without stiffening



87-1944

- Goatskin leather is the softest, most abrasion-resistant leather
- Highly recommended for applications requiring tactile sensitivity

High quality,
durable and
resists stains

STYLE	HIDE	GRADE	PATTERN	PALM	BACK	COLOR	CUFF	STITCHING	SIZES
5000	Top Grain Cowhide	Premium	Gunn	Single	Canvas	Natural	Safety, Rubberized	Nylon	S-XL
8000	Top Grain Cowhide	Premium	Gunn	Single	Canvas	Natural	Gauntlet, Rubberized	Nylon	S-2XL
87-2066	Top Grain Cowhide	Premium	Gunn	Single	Full Leather	Natural	Gauntlet, Rubberized	Kevlar	M-XL
87-1563P	Top Grain Cowhide	Economy	Gunn	Reinforced	Canvas	Blue/Black/Red	Safety, Rubberized	Nylon	MENS
5150	Top Grain Cowhide	Regular	Gunn	Single	Canvas	Green/Pink	Safety, Rubberized	Nylon	S-3XL
87-1563	Top Grain Cowhide	Regular	Gunn	Single	Canvas	Blue/Black/Red	Safety, Rubberized	Nylon	S-2XL
87-1663	Top Grain Cowhide	Regular	Gunn	Single	Canvas	Blue/Black/Red	Gauntlet, Rubberized	Nylon	S-XL
87-3563	Top Grain Pigskin	Premium	Gunn	Single	Canvas	Blue/Black/Red	Safety, Rubberized	Nylon	L-XL
87-1944	Top Grain Goatskin	Premium	Gunn	Single	Canvas	Red	Safety, Rubberized	Nylon	L



Serve & Protect

Parade and uniform gloves are used for formal occasions by police, firemen, marching bands, military and pallbearers.



Scan it

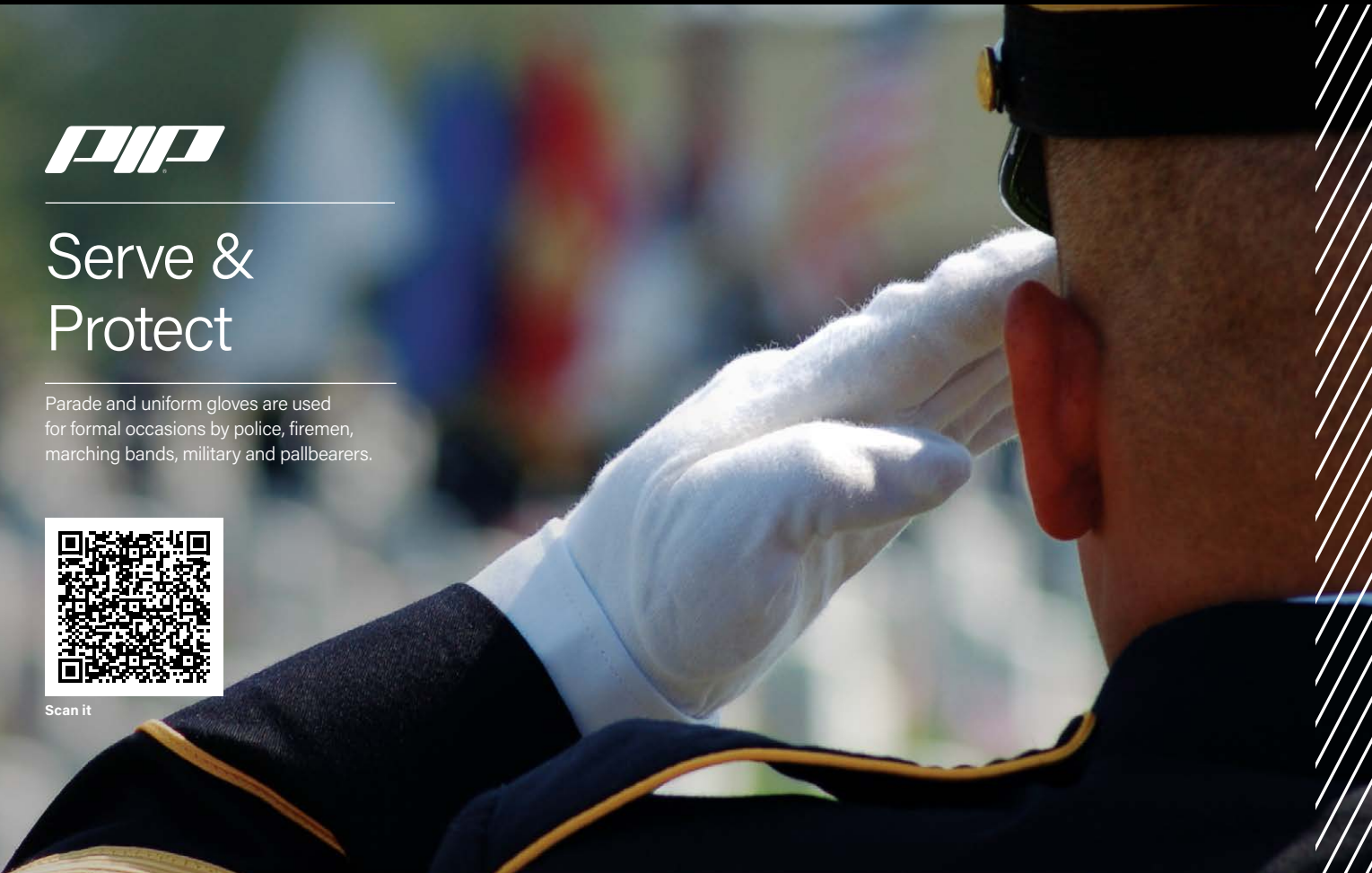

▲ 130-600GM



▲ 130-600WL



▲ 130-600WM



▲ 130-650BM



▲ 130-650WL



▲ 130-650WL

CABARET™ DRESS GLOVE

- Constructed in full fashion pattern with fourchettes and set-in thumbs for a tailored fit
- Three lines of raised stitching on back

Cabaret™ 100% Stretch Nylon Dress Glove

STYLE	COLOR	CUFF STYLE	HEM STYLE	PALM	RAISED STITCHING	SIZES
130-600GM	Gray	Open Cuff	-	Standard	With	Mens
130-600WL	White	Open Cuff	-	Standard	With	Ladies
130-600WM	White	Open Cuff	-	Standard	With	Mens
130-650BM	Black	Snap Closure	-	Standard	With	Mens
130-650WL	White	Snap Closure	-	Standard	With	Ladies
130-650WM	White	Snap Closure	-	Standard	With	Mens



White Glove Service

Hoteliers, Restaurateurs and General Catering



Scan it



▲ 130-100GM



▲ 130-100WM



▲ 130-100WMNZ



DOTTED PALM

▲ 130-100WMPD



▲ 130-150WM



▲ 97-520R



▲ 97-520H



▲ 97-520



▲ 97-521

CABARET™ COTTON GLOVE

- Constructed in full fashion pattern with fourchettes and set-in thumbs for a tailored fit
- Three lines of raised stitching on back

Cabaret™ 100% Cotton Dress Glove

STYLE	COLOR	CUFF STYLE	HEM STYLE	PALM	RAISED STITCHING	SIZES
130-100GM	Gray	Open Cuff	-	Standard	With	Mens
130-100WM	White	Open Cuff	-	Standard	With	S-XL
130-100WMNZ	White	Open Cuff	-	Standard	Without	XS-XL
130-100WMPD	White	Open Cuff	-	Plastic Dotted	With	S-XL
130-150WM	White	Snap Closure	-	Standard	With	S-XL
Medium Weight Two-Piece Ambidextrous Cotton Glove						
97-520R	White	-	Rolled	-	-	Mens
97-520H	White	-	Overlock Stitch	-	-	Mens
97-520	White	-	Unhemmed	-	-	Mens
97-521	White	-	Unhemmed	-	-	Ladies

SECTION:

High Performance Gloves



MADE FOR WORKING™



TOUGHEST MATERIALS.
TOUGHEST STANDARDS.
TOUGHEST PROTECTION.™

This section contains high performance task-specific gloves. These are field-tested gloves, designed for real-world environments using advanced, composite materials and built to deliver a higher level of performance in the harshest conditions. Key markets include Oil & Gas, Mining, Construction, Electrical and Gas Utilities and Mechanical Trades.

EVERY INDUSTRY HAS SPECIFIC NEEDS

High Performance gloves are generally considered to be gloves that are designed and built for the toughest of jobs. Key applications include Oil & Gas, Heavy Industry, Mining, Trench Work and Construction. These gloves are typically composed of multiple materials that may include natural leathers and/or tough synthetics that are highly cut, tear and puncture-resistant. Key to the enhanced protective nature of these gloves is the back-of-hand impact protection where thermoplastic rubber (TPR) or similar elastomers are carefully applied to maximize coverage, protection and flexibility. The recently released ANSI 138 standard for back-of-hand impact protection provides a testing and scoring method for impact protection. It allows for a score of 1 to 3, low to high, based on the mean transmitted force across several specific points across the back of the hand, knuckles and fingers.

Task-specific and **Mechanics gloves** are gloves that are designed for specific jobs. Our product developers take the time to understand every aspect of a job to learn the pain points, the high-risk points and the high wear points. Then they find the right glove design that mitigates all of these while providing the wearer with comfort and dexterity to do the job.

ARC Rated (AR) gloves help provide flame and thermal protection from exposure to an electrical ARC flash. Gloves are a vital component of PPE worn to protect workers while working around energized equipment. AR rated gloves are designed and treated to help limit exposure and burn percentage as a result of an electrical ARC flash incident. The National Fire Protection Association (NFPA) outlines four ARC Flash PPE Categories to classify ranges of ARC flash hazards and the corresponding requirements for Personal Protective Equipment (PPE).

Flame resistant (FR) gloves earn their designation because they are made of fabrics that are inherently resistant to or are treated to be resistant to igniting when exposed directly to flame. The material resists ignition or is designed to self-extinguish when ignited. FR gloves can also be designed with an extra liner that provides a thermal barrier to help protect the wearer's skin when exposed to direct heat energy and help minimize the risk.



HEAVY DUTY



IMPACT



ARC FLASH



FLASH FIRE



Oil, Gas and Mining



Scan it

Handling and Moving Heavy Materials /
Repair and Maintenance / Operating
Heavy-Duty Machinery and Tools /
Manipulating, Positioning and
Assembling Large Heavy Objects



DUAL-ACTION PALM



120-MP2415

BOSS®

- Silicone grip delivers unparalleled grip in dry and light oil applications
- PVC palm patch provides increased abrasion resistance and allows rope and chains to slide through the hand when guiding



HIGH-RISK IMPACT PROTECTION



120-MP3120

BOSS®

- PVC palm provides enhanced abrasion resistance and extended wear for heavy-duty jobs
- Includes unparalleled D30® foam layer that provides ANSI 138 Level 3 impact protection



120-MP2120

BOSS®

- PVC palm provides enhanced abrasion resistance and extended wear for heavy-duty jobs
- Double-stitched for long-lasting performance



120-MP2110

BOSS®

- PVC dot pattern channels oil while providing enhanced grip
- Flex points added on fingers for better grip and dexterity



120-MP2100

BOSS®

- Cotton corded palm absorbs and channels oil away from surface to provide improved grip
- Hi-Vis color for added visibility



REINFORCED THUMB CROTCH



87015

R15™

- Synthetic leather double palm with reinforced red PVC grip
- Heavy-duty TPR knuckle provides superior pinch protection



120-5150

TUFFMAX5™

- Lightweight HPPE shell provides excellent dexterity
- Nitrile MicroSurface coating provides good grip in oily conditions and a secure grip in dry conditions



87812

R2™

- Insulated for cold weather environments
- Green cotton corded palm provides a secure oily grip



120-5130

TUFFMAX3™

- Lightweight HPPE shell provides excellent dexterity
- Secure dry and good oily grip

Optimal combination of durability, dexterity and visibility



87810
R2"
- Flexible TPR molded finger, thumb and back-of-hand impact protection
- Touchscreen compatible
- Red palm for easy signaling

BEST SELLER



87811
R2"
- Fleece lined, waterproof
- Flexible TPR molded finger, thumb and back-of-hand impact protection
- Touchscreen compatible
- Red palm for easy signaling

INSULATED BEST SELLER



120-5900
MAXIMUM SAFETY™ MOG™
- Reinforced synthetic leather palm for secure dry and good oily grip



87010
R2 RIGACE™
- Silicone honeycomb grip repels liquids
- Designed to perform in slick conditions
- Operates well in a wide temperature range

REINFORCED THUMB CROTCH

Reduce the risk
to ensure maximum effectiveness

STYLE	ANSI CUT	EN388	ANSI 138	GRIP	BACK	CLIFF	COLOR	SIZES
120-5130	A2	4343BX	2	Nitrile MicroSurface	HPPE	Slip-On with Hook & Loop Closure	Hi-Vis Green/Black	S-2XL
120-5150	A4	4X44DP	2	Nitrile MicroSurface	HPPE	Slip-On with Hook & Loop Closure	Hi-Vis Orange/Black	M-2XL
120-5900	-	3111X	1	PVC Sandy Grip	Spandex	Slip-On with Hook & Loop Closure	Hi-Vis Orange/Black	M-3XL
120-MP2100	A2	1X21B	2	Cotton Corded	Spandex	Hook & Loop	Green / Black	M - 3XL
120-MP2110	A2	4X22B	2	Microfiber with PVC Dots	Spandex	Slip-On	Orange / Red / Yellow	M - 3XL
120-MP2120	A2	4X43B	2	PVC	Spandex	Slip-On	Hi-Vis Yellow / Red	M - 3XL
120-MP2415	A5	3X43E	2	Microfiber with Silicone	Spandex	Slip-On	Red / Yellow	M - 3XL
120-MP3120	A2	4X43B	3	PVC	Spandex	Slip-On	Black / Red / Orange	M - 3XL
87010	-	3221X	-	Silicone Pattern	Spandex	Slip-on	Hi-Vis Orange/Red/Hi-Vis Yellow	S-3XL
87015	A6	4543F	2	PVC Pattern	Spandex	Slip-on	Red/Yellow	S-3XL
87810	A2	-	1	Reinforced Polyurethane	Spandex	Slip-On with Hook & Loop Closure	Hi-Vis Yellow/Red/Black	S-3XL
87811	A2	-	1	Reinforced Polyurethane	Spandex	Slip-On with Hook & Loop Closure	Hi-Vis Yellow/Red/Black	S-3XL
87812	A3	1333C	-	-	Spandex	Slip-on	Hi-Vis Yellow	S-3XL



Heavy-Duty Work

Abrasive Material Handling / Heavy Equipment Operation / Operating Power Tools / Heavy Material Handling / Demolition / Industrial Maintenance and Repair



Scan it



BEST SELLER

120-4200
MAXIMUM SAFETY™
JOURNEYMAN™
- Internal foam padded palm dampens vibration
- Nylon spandex back for comfort and breathability



REINFORCED THUMB & FINGER

120-4600
MAXIMUM SAFETY™ VIZ™
- Synthetic leather palm provides good dry and light oily grip
- PVC on index finger and thumb for fine parts handling



86400
IRONCAT™
HEAVY-DUTY GRAIN DEERSKIN GLOVES
- Mechanics style protects from scrapes & abrasions, ideal for professional mechanics



PADDLED KNUCKLE

89301
EXTREME WORK™
- Tough-X™ suede with padded palm minimizes vibration
- Reinforced fingertips and thumb crotch for added durability



HI-VISIBILITY

89306
EXTREME WORK™
STRIKE PROTEX™
- Tough-X™ suede lasts up to 5x longer than traditional synthetic leathers
- TPR for added impact and pinch protection



TOUCHSCREEN COMPATIBLE

89308
EXTREME WORK™
- Tough-X™ suede lasts up to 5x longer than traditional synthetic leathers
- Spandex back for added comfort and breathability



NEW

1JM500
BOSS™
- Synthetic leather palm with PVC panels provides good dry and light oily grip

Designed to withstand heavy-duty handling and highly abrasive jobs

Heavy-Duty Work Gloves

STYLE	EN388	GRIP	BACK	CLIFF	COLOR	SIZES
120-4200	2112	Goatskin Leather	Reinforced Goatskin Leather	Slip-on	Black/Brown	S-2XL
120-4300	-	PVC Sandy Grip	Neoprene / Nylon	Slip-On with Hook & Loop	Black/Gray	S-2XL
120-4600	-	Silicone	Spandex	Slip-On with Hook & Loop	Hi-Vis Orange/Black	S-2XL
120-4720	1221	Polycord Canvas	Spandex	Slip-on	Hi-Vis Orange	M-2XL
86400	-	Deerskin Leather	Spandex	Slip-On with Hook & Loop	Gold/Black	M-2XL
89300	-	Tough-X™ Suede	Spandex	Slip-on	Black/Gray	S-2XL
89301	-	Tough-X™ Suede	Spandex	Slip-On with Hook & Loop	Black Gray	S-2XL
89302	-	Silicone Pattern	Spandex	Slip-On with Hook & Loop	Black/Blue	M-2XL
89302GY	-	Silicone Pattern	Spandex	Slip-On with Hook & Loop	Black/Gray	M-2XL
89303	-	PVC Sandy Grip	Spandex	Slip-On with Hook & Loop	Black/Red	S-2XL
89303GY	-	PVC Sandy Grip	Spandex	Slip-On with Hook & Loop	Black/Gray	S-2XL
89306	-	PVC Sandy Grip	Spandex	Slip-On with Hook & Loop	Black/Hi-Vis Green	M-2XL
89307	-	Tough-X™ Suede	Spandex	Slip-On with Hook & Loop	Black/Gray	M-2XL
89308	-	PVC Sandy Grip	Spandex	Slip-On with Hook & Loop	Black/Hi-Vis Green	S-2XL
89308OR	-	PVC Sandy Grip	Spandex	Slip-On with Hook & Loop	Black/Hi-Vis Orange	S-2XL
1JM500	-	Synthetic Leather	Spandex	Slip-On with Hook & Loop	Hi-Vis Orange/Black	M-3XL

Heavy-Duty Leather Drivers

STYLE NUMBER	ANSI CUT	EN388	ANSI/ISEA 138	HIDE	LINER MATERIAL	LINER COLOR	SIZES
9916	A7	-	Impact Level 1	Grain Goatskin Leather	Kevlar® Blend	Yellow	S-3XL
9920	A4	-	Impact Level 2	Grain Goatskin Leather	Kevlar® Blend	Yellow	S-3XL



ARC Rated / FR



Scan it

Installation, Maintenance, and Repairing
Electrical Distribution and Transmission System
Framing and Setting Poles and Meters /
Attaching and Testing Grounding Devices
to Remove Electrical Hazards



ANSI
A5

09-LC533AR
BOSS' XTREME TOP
GRAIN GOATSKIN

- Drivers gloves feature slip-on styling to provide good fit and comfort
- Aramid liner for added cut and heat protection



ANSI
A4

KS992K
BOSS' XTREME TOP
GRAIN COWHIDE

- Drivers gloves feature slip-on styling to provide good fit and comfort
- Aramid liner for added cut and heat protection



ANSI
A4

KS9911KP
OIL ARMOR™

- Oil Armor™ technology finish applied after tanning to enhance resistance to oil and dirt



ANSI
A4

KS993KOA
OIL ARMOR™

- Finish enhances resistance to oil and dirt



ANSI
A4

KS993KOAB
OIL ARMOR™

- Oil Armor™ finish applied after tanning to enhance resistance to oil and dirt
- TPR for added impact and pinch protection



ANSI
A2

09-K3750
MAXIMUM SAFETY™
TOP GRAIN GOATSKIN

- Drivers gloves feature slip-on styling to provide good fit and comfort
- Kevlar™ liner



ANSI
A6

713KSSN
POSIGRIP™
ARAMID BLENDED GLOVE

- Aramid blended shell provides resistance to low heat and spark



ANSI
A4

16-AR413
G-TEK™ POLYKOR™
BLENDED GLOVE

- Aramid blended shell provides excellent cut resistance and protects against low heat and sparks
- Secure grip in dry, wet and oily conditions

Tailored to deliver exceptional performance
in extreme environments

Arc Rated Gloves

STYLE	ANSI CUT	EN388	ANSI 138	EN 407	PPE CATEGORY	CAL/CMF	GRIP	LINER	BACK	CUFF	COLOR	SIZES
09-K3750	A2	3322BX	-	-	3	28.5	Top Grain Goatskin Leather	Kevlar™	Goatskin Leather	Slip-on	Natural	S-3XL
09-LC533AR	A5	2X32E	-	-	4	44	Top Grain Goatskin Leather	Aramid	Goatskin Leather	Slip-On	Natural	S-3XL
16-AR413	A4	3X4DX	-	-	2	13	MicroSurface Neoprene	Aramid Blended	-	Knit Wrist	Green/Black	S-2XL
713KSSN	A6	4542FX	-	-	1	4.4	Nitrile Foam	Aramid Blended	-	Knit Wrist	Green/Black	XS-3XL
KS9911KP	A4	2524DX	-	-	4	43	Top Grain Goatskin Leather	Aramid/Fleece	Goatskin Leather	Slip-on	Brown	S-3XL
KS992K	A4	2432DX	-	-	4	43	Top Grain Cowhide Leather	Kevlar™	Cowhide Leather	Slip-on	Natural	S-3XL
KS993KOA	A4	2524DX	-	-	4	43	Top Grain Goatskin Leather	Aramid	Goatskin Leather	Slip-on	Brown	S-3XL
KS993KOAB	A4	2524DX	2	-	4	43	Top Grain Goatskin Leather	Aramid	Goatskin Leather	Slip-on	Brown	S-3XL



Scan it



Mechanics

Mechanical Equipment Maintenance and Repair / Parts Inspection and Cleaning /
Operating Pneumatic and Power Tools



120-4900
MAXIMUM SAFETY™
BRICKYARD™
- Synthetic leather palm provides good dry and light oily grip
- Silicone palm coating



BEST SELLER

120-MX2805
MAXIMUM SAFETY™
MECHANICS GLOVES
- Designed to protect the professional mechanic from heat, cold and abrasion
- Launderable

STYLE	GRIP	BACK	CUFF	COLOR	SIZES
120-4500	Silicone	Neoprene/Nylon	Slip-On with Hook & Loop Closure	Gray/Black	S-2XL
120-4900	Silicone	Neoprene/Nylon	Slip-On with Hook & Loop Closure	Black/Gray	S-2XL
120-MX2805	Amará Synthetic Leather	Elastane/Polyester	Slip-On with Hook & Loop Closure	Black	S-2XL



Scan it



Task-Specific

Operating Vibrating Tools and Equipment / Maintenance and Repair
Lifting and Handling Medium to Heavy Objects



BEST SELLER

120-4400
MAXIMUM SAFETY™
GUNNER™ AV
- Synthetic leather palm provides good dry and light oily grip
- NeoRubber inserts



122-169
MAXIMUM SAFETY™
ANTI-VIBRATION
- Cowhide leather construction provides comfort, durability



BREATHABLE MESH BACK

122-AV14
MAXIMUM SAFETY™
LIFTING GLOVES
- Ergonomic design reduces hand fatigue
- Crocheted cotton mesh back for breathability



122-AV70
MAXIMUM SAFETY™
LIFTING GLOVES
- Ergonomic design reduces hand fatigue
- Palm pad insert absorbs and dampens shock to the joints of the hand

Designed to reduce hand fatigue

Anti-Vibration Gloves

STYLE	GRIP	BACK	CUFF	COLOR	SIZES
120-4400	PVC Sandy Grip	Neoprene/Nylon	Slip-On with Hook & Loop	Black/Gray	S-2XL
122-169	Top Grain Cowhide Leather	Split Cowhide Leather	Slip-on	Beige/Gray	S-2XL
122-AV71	Goatskin Leather	Lycra™	Hook & Loop Closure	Black	S-XL

Lifting Gloves

122-AV14	Leather	Crocheted Cotton	Hook & Loop Closure	Black	S-2XL
122-AV70	Sheepskin Leather	Stretch Fabric	Hook & Loop Closure	Black/Gold	S-2XL

SECTION:

Arm Protection



KUT GARD®

MADE IN AMERICA
ARM PROTECTION SOLUTIONS
FOR INDUSTRIAL WORKERS

Kut Gard® is the Made in America brand for factories and operations demanding the highest level of cut resistant sleeves. Proprietary engineered yarns and the ability to configure custom solutions make Kut Gard® the brand of choice for safety managers.

CLAW COVER®

THE #1 TRUSTED BRAND
FOR HIGH-RISK FOOD
INDUSTRY WORKERS

Made in the USA, Claw Cover® sleeves are designed to provide high-level cut protection while complying with both U.S. and Canadian standards for food contact. Claw Cover® sleeves are launderable and can be used for operations where direct, indirect, and incidental contact with food may occur.

YARN & FIBER TECHNOLOGIES

ACP™ & ATA proprietary blends use encapsulated glass fibers to create a strong, cut resistant option with no skin irritation.

Dyneema® is made from ultra-high molecular weight HPPE, offering superior strength and high cut resistance. Dyneema® and the stronger **Dyneema® Diamond fiber technology** is soft and comfortable and dissipates heat for a cool-wearing effect. Dyneema® fibers are not designed for use near heat or in flame-resistant applications.

Kevlar® (Para-Aramid) is inherently flame resistant and known for its high strength and excellent cut resistance. Kevlar® is blended with different materials like ACP™ or cotton to enhance its performance.

PolyKor® Xrystal™ is a proprietary PIP® yarn blended with Para-Aramid and HPPE to greatly enhance cut protection without the use of glass or steel.

PolyKor® combines PIP's proprietary fibers and engineered yarns to produce affordable cut resistant sleeves designed to surpass performance characteristics to optimize comfort and function for every application.

Pritex® is a proprietary synthetic blend with inherent antimicrobial properties. Offered in general purpose styles for protection against minor scrapes and contamination or blended with cut resistant fibers like Dyneema®/ACP™ or Kevlar®/ACP™ as an economical alternative to higher-priced blends.

Cotton is a natural fiber that provides sweat absorption and all-day comfort.

Polyester is a more durable alternative to cotton offering added protection from abrasion.



GLASS
HANDLING

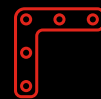

METAL
HANDLING



SHARP PARTS
ASSEMBLY



HEAT
RESISTANCE



INDUSTRIAL



CONSTRUCTION



CUTTING



CHOPPING



FILETING

Antimicrobial treatment used on sleeve fiber yarns help to inhibit bacteria, mold and mildew from developing in the presence of sweat and moisture, thereby improving comfort and extending the life of the sleeve.

Products referenced as "Compliant with FDA 21 CFR 177.2800" refer specifically to PART 177 - INDIRECT FOOD ADDITIVES: POLYMERS Sec. 177.2800 Textiles and textile fibers. Textiles and textile fibers may safely be used as articles or components of articles intended for use in producing, manufacturing, packing, processing, preparing, treating, packaging, transporting, or holding food.



Easy-To-Order Sleeve & Glove Combinations

KUT GARD® HIGH RISK

Sheet Metal and Stamping / Glass Handling / Automotive

Scan it



**PROTECTION DOES NOT
END AT THE WRIST**



Kut Gard® ACP™ / Kevlar® Blend Cut Resistant Sleeves

STYLE	ANSI CUT	MATERIAL	CONSTRUCTION	PLY	TOP CUFF	BOTTOM CUFF	COLOR	LENGTH
10-21KABK	A3	ACP™ / Kevlar® Blend	Smart-Fit™ Seamless Knit	1-Ply	Serged	Straight	Gray	18"
10-21KABK-ET	A3	ACP™ / Kevlar® Blend	Smart-Fit™ Seamless Knit	1-Ply	Serged	Thumb Elastic	Gray	18"
10-21KABKTH	A3	ACP™ / Kevlar® Blend	Smart-Fit™ Seamless Knit	1-Ply	Serged	Thumb Hole	Gray	18"
10-KABBK	A4	ACP™ / Kevlar® Blend	Blousy Fit	1-Ply	Serged	Straight	Gray	18"-22"
10-KABBKTH	A4	ACP™ / Kevlar® Blend	Blousy Fit	1-Ply	Serged	Thumb Hole	Gray	18"
10-KABK	A5	ACP™ / Kevlar® Blend	Regular	1-Ply	Serged	Straight	Gray	18"
10-KABKTH	A5	ACP™ / Kevlar® Blend	Regular	1-Ply	Serged	Thumb Hole	Gray	18"-22"
10-KASBK	A3	ACP™ / Kevlar® Blend	Regular	1-Ply	Serged	Straight	Gray	14"-18"
10-KASBTH	A3	ACP™ / Kevlar® Blend	Regular	1-Ply	Serged	Thumb Hole	Gray	18"

REPLACE STANDARD 18" LENGTH WITH ANY CUSTOM LENGTH FROM 10" - 24"

Kut Gard® ACP™ / Kevlar® Blend Cut Resistant Gloves

STYLE	ANSI CUT	MATERIAL	CONSTRUCTION	GAUGE	WEIGHT	COATING	COLOR	SIZES	PROP 65
07-KAB720	A6	ACP™ / Kevlar® Blend	Seamless Knit	7	Heavyweight	Uncoated	Gray	M-XL	-
07-KAB750	A4	ACP™ / Kevlar® Blend	Seamless Knit	13	Lightweight	Uncoated	Gray	XS-XL	-
08-KAB750PD	A4	ACP™ / Kevlar® Blend	Seamless Knit	13	Lightweight	PVC Dot	Gray	XS-XL	-
08-KAB750PDD	A4	ACP™ / Kevlar® Blend	Seamless Knit	13	Lightweight	PVC Dot Double-Sided	Gray	XS-XL	-

C= ⚠️ WARNING: Cancer - www.P65Warnings.ca.gov R= ⚠️ WARNING: Reproductive Harm - www.P65Warnings.ca.gov C&R= ⚠️ WARNING: Cancer and Reproductive Harm - www.P65Warnings.ca.gov



Scan it

**KUT
GARD®**

SMART-FIT™ Sleeves

ONE-SIZE-FITS-ALL SLEEVE SOLUTION

Sheet Metal and Stamping / Glass Handling / Assembly / Automotive

 <p>ANSI A8</p> <p>10-V21DAX</p> <ul style="list-style-type: none"> - PolyKor® Xrystal® / Aramid blend is lightweight and provides protection against high cut hazards - Excellent FR properties will not melt or sustain a flame - 100% silicone-free <p>HIGH RISK & DURABLE</p>	 <p>ANSI A5</p> <p>20-21HX</p> <ul style="list-style-type: none"> - PolyKor® Xrystal® blended knit is lightweight and provides excellent protection against medium cut hazards - Withstands repeated washing in chlorine bleach and caustic detergents to remove dirt, odor, grease, oil and bacteria - 100% silicone-free <p>TOUGHEST WEARING</p>	 <p>ANSI A5</p> <p>10-21AXTH</p> <ul style="list-style-type: none"> - PolyKor® Xrystal® blended knit is lightweight and provides protection against medium cut hazards - Integrated thumb hole allows protection all the way to the knuckle without sacrificing dexterity - Excellent FR properties will not melt or sustain a flame <p>EXTRA COVERAGE</p>	 <p>ANSI A4</p> <p>15-21KVBK</p> <ul style="list-style-type: none"> - Proprietary ACP® / Kevlar® / Pritex® blend with antimicrobial fibers provides exceptional comfort and will not cause skin irritation - Excellent abrasion resistance - Silicone and latex-free <p>BEST SELLER</p>
 <p>ANSI A3</p> <p>20-21DACP</p> <ul style="list-style-type: none"> - Proprietary ACP® / Dyneema® blend provides excellent protection for light cut risks, lacerations and abrasions - Lightweight and comfortable, will fit over clothing or directly on the arm - 100% silicone-free - Meets FDA & USDA food handling requirements 	 <p>ANSI A3</p> <p>10-21KABK</p> <ul style="list-style-type: none"> - Proprietary ACP® / Kevlar® blend provides excellent protection from low levels of heat and spark - 100% silicone-free 	 <p>ANSI A3</p> <p>10-21KABK-ET</p> <ul style="list-style-type: none"> - Proprietary ACP® / Kevlar® blend provides excellent protection from low levels of heat and spark - Elastic thumb strap provides an improved fit when worn with hand protection - 100% silicone-free 	 <p>ANSI A2</p> <p>15-21PRIBPS-ET</p> <ul style="list-style-type: none"> - Proprietary Pritex® blend with antimicrobial fibers provides exceptional comfort and helps prevent skin irritation - Silicone and latex-free

Kut Gard® Smart Fit™ Technology

STYLE	ANSI CUT	MATERIAL	CONSTRUCTION	PLY	TOP CUFF	BOTTOM CUFF	COLOR	STANDARD LENGTH
10-21ACPCBTH	A4	ACP® / Kevlar® Blend	Smart-Fit™ Seamless Knit	1	Serged	Thumb Hole	Green	18"
10-21AXTH	A5	PolyKor® Xrystal® / Aramid Blend	Smart-Fit™ Seamless Knit	1	Serged	Thumb Hole	Yellow	18"
10-21HACPNY-ET	A3	ACP® / Kevlar® Blend	Smart-Fit™ Seamless Knit	1	Serged	Thumb Elastic	Neon Yellow	18"
10-21KABK	A3	ACP® / Kevlar® Blend	Smart-Fit™ Seamless Knit	1	Serged	Straight	Gray	18"
10-21KABK-ET	A3	ACP® / Kevlar® Blend	Smart-Fit™ Seamless Knit	1	Serged	Thumb Elastic	Gray	18"
10-21KABKTH	A3	ACP® / Kevlar® Blend	Smart-Fit™ Seamless Knit	1	Serged	Thumb Hole	Gray	18"
10-21KVACPMBK	A4	ACP® / Kevlar® Blend	Smart-Fit™ Seamless Knit	1	Serged	Straight	Green	18"
10-21KVACPMBK-ET	A4	ACP® / Kevlar® Blend	Smart-Fit™ Seamless Knit	1	Serged	Thumb Elastic	Green	18"
10-21KVACPMBKTH	A4	ACP® / Kevlar® Blend	Smart-Fit™ Seamless Knit	1	Serged	Thumb Hole	Green	18"
15-21KVBK	A4	ACP® / Kevlar® / Pritex® Blend	Smart-Fit™ Seamless Knit	1	Serged	Straight	Green	14"
15-21PRIBPS-ET	A2	Pritex®	Smart-Fit™ Seamless Knit	1	Serged	Thumb Elastic	Black	18"
15-21PRIWPS-ET	A2	Pritex®	Smart-Fit™ Seamless Knit	1	Serged	Thumb Elastic	White	18"
20-21DACP	A3	ACP® / Dyneema® Blend	Smart-Fit™ Seamless Knit	1	Serged	Straight	Gray	18"
20-21DACPBTHPT	A4	ACP® / Dyneema® Blend	Smart-Fit™ Seamless Knit	1	Serged	Thumb Hole	Salt & Pepper	18"
20-21DACP-ET	A3	ACP® / Dyneema® Blend	Smart-Fit™ Seamless Knit	1	Serged	Thumb Elastic	Gray	18"
20-21DHX-ET	A8	PolyKor® Xrystal®	Smart-Fit™ Seamless Knit	2	Serged	Thumb Elastic	Gray	18"
20-21HX	A5	PolyKor® Xrystal®	Smart-Fit™ Seamless Knit	1	Serged	Straight	Gray	18"
20-21XS	A5	PolyKor® Xrystal® / Supreme® Blend	Smart-Fit™ Seamless Knit	1	Serged	Straight	Brown	18"

REPLACE STANDARD 18" LENGTH WITH ANY CUSTOM LENGTH FROM 10" - 24"



**KUT
GARD®**

FR and ARC Flash Protective Sleeves

Installing Electrical Equipment / Pulling Wire and Cable
Installing Cable / Tray & Conduit / Connecting Wires



Scan it



ANSI
A2

10-K46

- FR Viscose / Kevlar® blend provides excellent thermal and flame protection from high heat and open flame
- Elastic end provides a snug fit and helps eliminate debris from entering the sleeve
- Thumb hole allows protection all the way to the knuckle without sacrificing dexterity



ANSI
A5



10-KAM

- ARC-Rating ATPV: 9.5 cal/cm² to protect against dangerous electric arc flashes
- Proprietary ACP® technology and Kevlar® blend provides excellent protection against heat, cuts, lacerations and abrasions
- Thumb hole allows protection all the way to the knuckle

FR AND ARC FLASH PROTECTION

FR Sleeves

STYLE	ANSI CUT	MATERIAL	ARC RATED	CONSTRUCTION	PLY	TOP CUFF	BOTTOM CUFF	COLOR	STANDARD LENGTH
10-K46	A2	60% FR Viscose 40% Dupont® Kevlar® Blend	-	DuPont® Kevlar® Wrist with Thumb Hole & Blue/Gold Elastic at Top	1	Serged	Straight	Yellow/Brown	18"

ARC Flash Sleeves

10-KAM	A5	ACP® / Kevlar® Blend	ARC-Rating ATPV: 9.5 cal/cm ²	Cut-and-Sewn	2	Serged	Thumb Hole	Gray	18"
---------------	----	----------------------	--	--------------	---	--------	------------	------	-----

REPLACE STANDARD 18" LENGTH WITH ANY CUSTOM LENGTH FROM 10"-24"

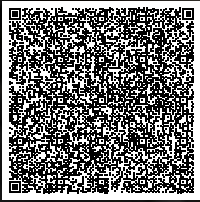

Scan it

**KUT
GARD®**

Cut Resistant Sleeves

FORM-FITTING SEAMLESS KNIT SLEEVES
FLEXIBLE AND COOL WEARING

Automotive / Glass Operations / Sheet Metal Fabrication / Manufacturing of Appliances and Metal Enclosures

POLYKOR®

Affordable protection optimized to deliver comfort and performance that workers demand



ANSI
A5

10-21AX

- Resistant to low heat and spark
- Smart-Fit™ technology raises the standard for performance knit sleeves offering a unique stretch and recovery
- 100% silicone-free



ANSI
A4

20-HXB

- PolyKor® Xrystal™ blended provides medium protection from cuts and scrapes
- Blousy construction offers a loose fit to reduce fatigue
- 100% silicone free

DYNEEMA®

Unparalleled comfort and coolness while providing cut and abrasion resistance



ANSI
A3

20-TGNS

- Spun Dyneema™ / nylon blend provides light protection from cuts and scrapes
- Offers unparalleled comfort and coolness while providing cut and abrasion resistance
- Elastic top provides a snug fit



ANSI
A2

20-D

- Economical protection from light cut hazards
- High resistance to abrasion
- Elastic top provides a snug fit

Kut Gard® PolyKor® Sleeves

STYLE	ANSI CUT	Z/CFR	MATERIAL	CONSTRUCTION	PLY	TOP CUFF	BOTTOM CUFF	COLOR	STANDARD LENGTH
10-21AX	A5	-	PolyKor® Xrystal® / Aramid Blend	Smart-Fit™ Seamless Knit	1	Serged	Straight	Yellow	18"
10-AXS	A4	-	PolyKor® Xrystal® / Aramid Blend	Seamless Knit	1	Serged	Straight	Yellow	18"
10-AXSTH	A4	-	PolyKor® Xrystal® / Aramid Blend	Seamless Knit Tube Knit	1	Serged	Thumb Hole	Yellow	18"
20-HXB	A4	-	PolyKor® Xrystal®	Blousy	1	Serged	Straight	Gray	18"
20-XSB	A4	-	PolyKor® Xrystal® / Suprene® Blend	Blousy	1	Serged	Straight	Brown	18"
Kut Gard® With Dyneema® / Dyneema® Diamond									
20-21DACPTH	A4	-	ACP® / Dyneema® Blend	Cut-and-Sewn	2	Serged	Thumb Hole	Gray	18"
20-D	A4	-	Dyneema® Diamond	Seamless Knit	1	Serged	Straight	White	10"
20-SD	A4	-	Spun Dyneema® / Nylon Blend	Seamless Knit	1	Serged	Straight	White	14"
20-TG	A4	-	Dyneema® Diamond	Seamless Knit	2	Serged	Straight	Gray	14"
20-TGNS	A4	-	Dyneema® Diamond	Seamless Knit	2	Serged	Straight	Gray	18"

REPLACE STANDARD 18" LENGTH WITH ANY CUSTOM LENGTH FROM 10" - 24"



ATA® / HPPE BLEND

Full range of proprietary blended cut resistant sleeves provide the best value in performance, comfort and high-risk protection



COLOR CODED HEM IDENTIFIES
ANSI CUT PROTECTION

ATA® TECHNOLOGY SLEEVES

- Protection against a wide range of cut hazards
- Offers unparalleled comfort and coolness while providing cut and abrasion resistance

Kut Gard® Made with ATA® Technology

STYLE	ANSI CUT	MATERIAL	CONSTRUCTION	PLY	TOP CUFF	BOTTOM CUFF	COLOR	STANDARD LENGTH
20-S13ATA/PE2	A2	ATA® Technology with HPPE	Machine Knit, Antimicrobial	1	Serged	Straight	Gray	18"
20-S13ATA/PE2-T	A2	ATA® Technology with HPPE	Machine Knit, Antimicrobial	1	Serged	Thumb Hole	Gray	18"
20-S13ATA/PE3	A3	ATA® Technology with HPPE	Machine Knit, Antimicrobial	1	Serged	Straight	Gray	18"
20-S13ATA/PE3-T	A3	ATA® Technology with HPPE	Machine Knit, Antimicrobial	1	Serged	Thumb Hole	Gray	18"
20-S13ATA/PE4	A4	ATA® Technology with HPPE	Machine Knit, Antimicrobial	1	Serged	Straight	Gray	18"
20-S13ATA/PE4-T	A4	ATA® Technology with HPPE	Machine Knit, Antimicrobial	1	Serged	Thumb Hole	Gray	18"
20-S13ATA/PE4-VEL	A4	ATA® Technology with HPPE	Machine Knit	2	Hook & Loop	Straight	Gray	18" / 22"
20-S13ATA/PE4-T-VEL	A4	ATA® Technology with HPPE	Machine Knit	2	Hook & Loop	Thumb Hole	Gray	18" / 22"
20-S13ATA/PE4HVO-VEL	A4	ATA® Technology with HPPE	Machine Knit	2	Hook & Loop	Straight	Orange	18" / 22"
20-S13ATA/PE4HVO-T-VEL	A4	ATA® Technology with HPPE	Machine Knit	2	Hook & Loop	Thumb Hole	Orange	18" / 22"
20-S13ATA/PE5	A5	ATA® Technology with HPPE	Machine Knit, Antimicrobial	1	Serged	Straight	Gray	18"
20-S13ATA/PE5-T	A5	ATA® Technology with HPPE	Machine Knit, Antimicrobial	1	Serged	Thumb Hole	Gray	18"
20-S13ATA/PE6	A6	ATA® Technology with HPPE	Machine Knit, Antimicrobial	1	Serged	Straight	Gray	18"
20-S13ATA/PE6-T	A6	ATA® Technology with HPPE	Machine Knit, Antimicrobial	1	Serged	Thumb Hole	Gray	18"
20-S10ATA/PE7	A7	ATA® Technology with HPPE	Machine Knit, Antimicrobial	1	Serged	Straight	Gray	18"
20-S10ATA/PE7-T	A7	ATA® Technology with HPPE	Machine Knit, Antimicrobial	1	Serged	Thumb Hole	Gray	18"
20-S10ATA/PE8	A8	ATA® Technology with HPPE	Machine Knit, Antimicrobial	1	Serged	Straight	Gray	18"
20-S10ATA/PE8-T	A8	ATA® Technology with HPPE	Machine Knit, Antimicrobial	1	Serged	Thumb Hole	Gray	18"
20-S10ATA/PE9	A9	ATA® Technology with HPPE	Machine Knit, Antimicrobial	1	Serged	Straight	Gray	18"
20-S10ATA/PE9-T	A9	ATA® Technology with HPPE	Machine Knit, Antimicrobial	1	Serged	Thumb Hole	Gray	18"

REPLACE STANDARD 18" LENGTH WITH ANY CUSTOM LENGTH FROM 10" - 24"



MADE WITH KEVLAR[®]

DuPont[™] Kevlar[®] is light, comfortable and provides protection against low heat and spark, cuts, lacerations and abrasions



ANSI
A3

10-BKDS

- Protection from light cut hazards
- Resistance to low heat and spark
- 2-ply for additional wear protection
- Dark color hides dirt



ANSI
A3

10-KS

- Protection from light cut hazards
- Resistance to low heat and spark
- 2-ply for additional wear protection



ANSI
A3

10-KSTO

- Protection from medium cut hazards
- Resistant to low heat and spark
- Exceptional comfort



ANSI
A2

10-KSS

- Protection from light cut hazards
- Resistant to low heat and spark
- 100% silicone free

ACP[™] / KEVLAR[®] BLEND

Lower cost alternative, provides protection against low heat and sparks, cut and abrasion hazards



ANSI
A5

10-KABK

- Protection from medium cut hazards
- Light heat protection
- 2-ply for extended wear and abrasion resistance



ANSI
A5

10-KANO

- Protection from medium cut hazards
- Resistant to low heat and spark
- Offers twice the cut resistance compared with traditional Aramid sleeves

HI-VISIBILITY



ANSI
A5

10-KANY

- Protection from medium cut hazards
- Resistant to low heat and spark
- Exceptional comfort

HI-VISIBILITY



ANSI
A3

10-KASCTOT

- Protection from light cut hazards
- Resistant to low heat and spark
- 100% silicone-free

BEST SELLER

Kut Gard[®] Made with DuPont[™] Kevlar[®] Cut Resistant Sleeves

STYLE	ANSI CUT	MATERIAL	CONSTRUCTION	PLY	TOP CUFF	BOTTOM CUFF	COLOR	LENGTH
10-BKDS	A3	DuPont [™] Kevlar [®]	Seamless Knit	2	Serged	Straight	Black	14"
10-KS	A3	DuPont [™] Kevlar [®]	Seamless Knit	2	Serged	Straight	Yellow	10"
10-KSB	A3	DuPont [™] Kevlar [®]	Blousy	1	Serged	Straight	Yellow	18"
10-KSCL	A3	DuPont [™] Kevlar [®]	Seamless Knit, with Cotton Liner	2	Serged	Straight	Yellow	14"
10-KSS	A2	DuPont [™] Kevlar [®]	Seamless Knit	1	Serged	Straight	Yellow	10"
10-KSTO	A3	DuPont [™] Kevlar [®]	Seamless Knit	2	Serged	Thumb Hole	Yellow	10"
10-KSTOLP	A3	DuPont [™] Kevlar [®]	Seamless Knit, with Leather Patch	2	Serged	Thumb Hole	Yellow	14"
10-KVSDGH	A6	DuPont [™] Kevlar [®]	Blousy	1	Serged	Straight	Gray	12"
10-KVSYBH	A6	DuPont [™] Kevlar [®]	Blousy	1	Serged	Straight	Green	12"
Kut Gard [®] ACP [™] / Kevlar [®] Blend Cut Resistant Sleeves								
10-KA	A5	ACP [™] / Kevlar [®] Blend	Seamless Knit	2	Serged	Straight	Green	14"
10-KABK	A5	ACP [™] / Kevlar [®] Blend	Seamless Knit	2	Serged	Straight	Black	18"
10-KACL	A5	ACP [™] / Kevlar [®] Blend	Seamless Knit, with Cotton Liner	1	Serged	Straight	Green	24"
10-KANO	A5	ACP [™] / Kevlar [®] Blend	Seamless Knit	2	Serged	Straight	Neon Orange	18"
10-KANOCL	A5	ACP [™] / Kevlar [®] Blend	Seamless Knit, with Cotton Liner	2	Serged	Straight	Neon Orange	20"
10-KANOS	A3	ACP [™] / Kevlar [®] Blend	Seamless Knit	1	Serged	Straight	Neon Orange	18"
10-KANP	A5	ACP [™] / Kevlar [®] Blend	Seamless Knit	1	Serged	Straight	Neon Pink	18"
10-KANY	A5	ACP [™] / Kevlar [®] Blend	Seamless Knit	2	Serged	Straight	Neon Yellow	18"
10-KASBKTH	A3	ACP [™] / Kevlar [®] Blend	Seamless Knit	1	Serged	Thumb Hole	Gray	18"
10-KASCTOT	A3	ACP [™] / Kevlar [®] Blend	Seamless Knit	1	Serged	Thumb Hole	Green	24"

REPLACE STANDARD 18" LENGTH WITH ANY CUSTOM LENGTH FROM 10" - 24"

ATA® / ARAMID

Proven performance against heat and spark, cut and abrasion at a lower cost per use than traditional Aramid alternatives



ANSI
A5

S10ATAFR/5HA-ES6

- Available in 3 widths
- Protection against heat and cut hazards
- Stay-up top to keep sleeves in place



ANSI
A4

S10ATAFR/4-ES6

- Available in 3 widths
- Protection against heat and cut hazards
- Sta-COOL™ plating for cooling comfort
- Stay-up top to keep sleeves in place*



ANSI
A3

10-SATA/HAFR-T

- Protection against medium heat and cut hazards
- Hide-Away™ FR technology hides dirt and grime"



ANSI
A2

S13ATAFR/2HA-ES6

- Available in 3 widths
- Protection against heat and light cut hazards
- Stay-up top to keep sleeves in place

MADE WITH ARAMID

Lightweight, comfortable and provides protection against low heat and spark, cuts, lacerations and abrasions



ANSI
A3

MSK

- 2-ply for additional wear protection
- Resistance to low heat and spark

Also available with thumb hole:
MSK-T



ANSI
A2

MSK1

- Protection from light cut hazards
- Resistance to low heat and spark



ANSI
A2

MSKC

- 2-ply Kevlar® lined with cotton for added comfort
- Resistance to low heat and spark

Kut Gard® Made with ATA®/Aramid Blended Fiber Technology

STYLE	ANSI CUT	MATERIAL	CONSTRUCTION	PLY	TOP CUFF	BOTTOM CUFF	COLOR	LENGTH
S10ATAFR/5HA-EW-ES6	A5	ATA® Technology Hide-Away™ FR Wide Width	Machine Knit	1	Stay-Up	Straight or Thumb Hole	Green	18" / 22"
S10ATAFR/5HA-ES6	A5	ATA® Technology Hide-Away™ FR Standard Width	Machine Knit	1	Stay-Up	Straight or Thumb Hole	Green	18" / 22"
S10ATAFR/5HA-NW-ES6	A5	ATA® Technology Hide-Away™ FR Narrow Width	Machine Knit	1	Stay-Up	Straight or Thumb Hole	Green	18" / 22"
S10ATAFR/4-EW-ES6	A4	ATA® Technology Hide-Away™ w/ Sta-COOL™ Wide Width	Machine Knit	1	Stay-Up	Straight or Thumb Hole	Green	18" / 22"
S10ATAFR/4-ES6	A4	ATA® Technology Hide-Away™ w/ Sta-COOL™ Standard Width	Machine Knit	1	Stay-Up	Straight or Thumb Hole	Green	18" / 22"
S10ATAFR/4-NW-ES6	A4	ATA® Technology Hide-Away™ w/ Sta-COOL™ Narrow Width	Machine Knit	1	Stay-Up	Straight or Thumb Hole	Green	18" / 22"
S13ATAFR/4HA-EW-ES6	A4	ATA® Technology Hide-Away™ FR Wide Width	Machine Knit	1	Stay-Up	Straight or Thumb Hole	Green	18" / 22"
S13ATAFR/4HA-ES6	A4	ATA® Technology Hide-Away™ FR Standard Width	Machine Knit	1	Stay-Up	Straight or Thumb Hole	Green	18" / 22"
S13ATAFR/4HA-NW-ES6	A4	ATA® Technology Hide-Away™ FR Narrow Width	Machine Knit	1	Stay-Up	Straight or Thumb Hole	Green	18" / 22"
10-SATA/HAFR	A3	ATA® Technology Hide-Away™ FR	Seamless Knit	1	Elastic	Straight or Thumb Hole	Green	18"
S13ATAFR/4HA-EW-ES6	A2	ATA® Technology Hide-Away™ FR Wide Width	Machine Knit	1	Stay-Up	Straight or Thumb Hole	Green	18" / 22"
S13ATAFR/4HA-ES6	A2	ATA® Technology Hide-Away™ FR Standard Width	Machine Knit	1	Stay-Up	Straight or Thumb Hole	Green	18" / 22"
S13ATAFR/4HA-NW-ES6	A2	ATA® Technology Hide-Away™ FR Narrow Width	Machine Knit	1	Stay-Up	Straight or Thumb Hole	Green	18" / 22"

Kut Gard® Made with Aramid Cut Resistant Sleeves

MSK	A3	Kut Gard® made with Aramid	Seamless Knit	2	Serged	Straight or Thumb Hole	Yellow	10" - 24"
MSK1	A2	Kut Gard® made with Aramid	Seamless Knit	1	Serged	Straight	Yellow	18"
MSKC	A2	Kut Gard® made with Aramid & Cotton Liner	Seamless Knit	2	Serged	Straight or Thumb Hole	Yellow	14"

REPLACE STANDARD 18" LENGTH WITH ANY CUSTOM LENGTH FROM 10" - 24"



Scan it



Claw Cover®

THE #1 TRUSTED BRAND FOR
HIGH-RISK FOOD INDUSTRY WORKERS

Cutting / Chopping / Trimming / Filleting



ANSI
A8

CS7GY-AC
- Protection from high cut hazards
- Alligator clip securely keeps the sleeve up on the arm



ANSI
A7

CS7LGY-AC
- Protection from high cut hazards
- Antimicrobial properties will not wash out of the fiber and will last the life of the sleeve



ANSI
A6

7-21
- Protection from high cut hazards
- Alligator clip securely keeps the sleeve up on the arm



ANSI
A6

MS2696
- Protection from medium cut hazards
- Antimicrobial properties will not wash out of the fiber and will last the life of the sleeve



ANSI
A5

MS-1097
- Protection from medium cut hazards
- Antimicrobial properties will not wash out of the fiber and will last the life of the sleeve

Also available with Alligator clip: **MS-1097-AC**



25-76BB



25-76BG



25-76GRN



25-76NP

ANSI
A7 **21**
CFR

HIGH CUT SLEEVES

- Excellent cut resistance protects against cuts and scrapes
- Antimicrobial fiber has been shown to inhibit the growth of microorganisms
- Unparalleled comfort, fit and coolness

MATCH THESE SLEEVES WITH
22-760 CUT RESISTANT GLOVES
ON PAGE 28

Claw Cover® Made with HPPE Technology

STYLE	ANSI CUT	21 CFR	MATERIAL	CONSTRUCTION	PLY	TOP CUFF	BOTTOM CUFF	COLOR	STANDARD LENGTH
MS-1097-AC	A5	Yes	Claw Cover® made with HPPE	Seamless Knit	1	Alligator Clip	Straight	Blue	18" - 22"
MS-1097	A5	Yes	Claw Cover® made with HPPE	Seamless Knit	1	Serged	Straight	Blue	22"
MS2696	A6	Yes	Claw Cover® made with HPPE	Seamless Knit	1	Serged	Straight	Gray	14"
CS7LGY-AC	A7	Yes	Claw Cover® made with HPPE	Seamless Knit	1	Alligator Clip	Straight	Gray	22"
CS7GY-AC	A8	Yes	Claw Cover® made with HPPE	Seamless Knit	1	Alligator Clip	Straight	Gray	18"
7-21	A6	Yes	Claw Cover® made with HPPE	Seamless Knit	1	Serged	Straight	White	21"

Claw Cover® Made with Polykor® Technology

25-6	A9	Yes	Claw Cover® made with Polykor®	Seamless Knit	1	Serged	Straight	White	18"
-------------	----	-----	--------------------------------	---------------	---	--------	----------	-------	-----

Claw Cover® Made with Dyneema® / Dyneema® Diamond Technology

25-76GRN	A7	Yes	Claw Cover® made with Dyneema®	Seamless Knit	1	Serged	Straight	Green	12"
25-76BB	A7	Yes	Claw Cover® made with Dyneema®	Seamless Knit	1	Serged	Straight	Bright Blue	12"
25-76BG	A7	Yes	Claw Cover® made with Dyneema®	Seamless Knit	1	Serged	Straight	Bright Green	12"
25-76NP	A7	Yes	Claw Cover® made with Dyneema®	Seamless Knit	1	Serged	Straight	Neon Pink	12"
20-DAPBTOV	A4	Yes	Claw Cover® made with ACP® / Dyneema®	Blousy	1	Hook & Loop	Thumb Hole	Gray	22"

REPLACE STANDARD 18" LENGTH WITH ANY CUSTOM LENGTH FROM 10" - 24"



Scan it

General Duty Sleeves

PRITEX®

Raises the standard for performance sleeves offering an increase in overall performance and value compared to traditional nylon and nylon/cotton blend sleeves



ANSI
A2
21
CFR

15-2BKL

- Pritex® blend with antimicrobial fibers provides exceptional comfort to reduce skin irritation
- ANSI Standard 51 Conformant approved antimicrobial fiber that is FDA & EPA approved for food contact
- Antimicrobial properties will not wash out of the fiber and will last the life of the sleeve



ANSI
A2
21
CFR

15-2WL

- Blousy construction offers a loose fit to reduce fatigue
- ANSI Standard 51 Conformant approved antimicrobial fiber that is FDA & EPA approved for food contact
- Antimicrobial properties will not wash out of the fiber and will last the life of the sleeve

CANE MESH AND GENERAL DUTY SLEEVES

Provide an extra layer of protection against cut or minor scrapes and abrasion for light duty applications



ANSI
A4

30-6795B

- 2-ply construction for added protection
- Exceptional comfort, lightweight, breathable, and shrink resistant
- Hook & loop closure for a snug, secure fit



MSC

- Lightweight, natural cotton construction keeps workers cool and comfortable
- 2-Ply construction for added protection
- Integrated thumb hole allows protection all the way to the knuckle without sacrificing dexterity

Kut Gard® Pritex®

STYLE	ANSI CUT	MATERIAL	CONSTRUCTION	PLY	TOP CUFF	BOTTOM CUFF	COLOR	STANDARD LENGTH	SIZES
15-2BKL	A2	Pritex®	Seamless Knit, Blousy, Antimicrobial Fibers	1	Serged	Straight	Black	14"	-
15-2BKSTO	A2	Pritex®	Seamless Knit, Blousy, Antimicrobial Fibers	1	Serged	Thumb Hole	Black	14"	-
15-2NPS	A2	Pritex®	Seamless Knit, Blousy, Antimicrobial Fibers	1	Serged	Straight	Neon Pink	14"	-
15-2WL	A2	Pritex®	Seamless Knit, Blousy, Antimicrobial Fibers	1	Serged	Straight	White	18"	-
Cane Mesh Sleeves									
30-6795B	A4	Nylon Cane Mesh	Cut-and-Sewn	2	-	-	Black	9"	S-4XL
General Duty Sleeves									
MSC	-	Cotton	Seamless Knit	2	Serged	Straight or Thumb Hole	Natural	12" - 24"	S-4XL

REPLACE STANDARD 18" LENGTH WITH ANY CUSTOM LENGTH FROM 10" - 24"

Above-the-neck PROTECTION

Above-the-neck products protect our sight, hearing, breathing and brain – all vital to sustain life. These are some of the most critical PPE that meets a variety of very strict industry requirements.



STRUCK-BY
HAZARDS



UNSAFE
PARTICULATES



NOISE-INDUCED
HEARING LOSS



IMPACT, SPLASH
& DEBRIS

84

HEAD PROTECTION includes ANSI Type I and Type II hard hats and safety helmets that by way of a protective shell and suspension system help attenuate impact force when struck by hard or falling objects. Bump caps help protect from scrapes and bumps that can be caused by walking or bumping into an object overhead in a confined space.

105

HEARING PROTECTION reduces the risk of cumulative and gradual hearing loss from work environments where noise levels typically exceed 85 decibels within an 8-hour time period. An environment that poses hearing hazards is one where individuals are consistently exposed to volume levels comparable to the noise produced by a lawn mower. PIP® ear plugs and muffs deliver a wide range of Noise Reduction Ratings (NRR), ranging from 20 to 32 dB.

113

DISPOSABLE RESPIRATORS are designed to meet stringent NIOSH requirements to help protect workers from airborne contaminants when working around particulate risks, filtering out between 95% to 99.97% of all particles that are 0.3 microns in diameter or larger.

121

EYE PROTECTION delivers maximum safety and enhanced productivity in hazardous environments by meeting the ANSI Z87.1-2015 standard for lens thickness, material, mounting and design and protection from impact, splash and debris. New lens technologies address common workplace hazards such as fogging, hindered vision and eye strain from glare and overexposure to blue light.

SECTION:

Head Protection



PROVEN PROTECTION. PROVEN PERFORMANCE™

Because there are so many different industries and applications where head protection is required, there are multiple categories and styles of head protection to consider. Evaluating the work environment and assessing the hazards is a crucial first step.

PIP® offers an extensive line of safety helmets and hard hats that protect workers from falling objects in multiple industries, from heavy-duty mining to residential construction, as well as bump caps for use in workspaces where hard hats are not mandated.

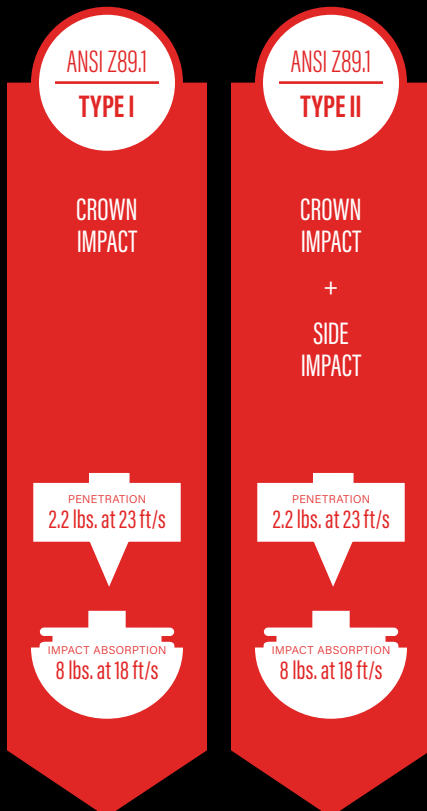

HEAD PROTECTION DISTINCTIONS

Hard hats and safety helmets are classified by ANSI standard Z89.1 and CSA standard 94.1 as Type I for top of head protection or Type II for lateral impact protection. Both types are tested for impact attenuation and penetration resistance. Type II performance requirements include criteria for impact energy attenuation from force incurred at the front, back and sides of the head as well as for off-center penetration resistance and chin strap retention.

TYPE I

Designed to protect workers from objects and blows that come from above, or from contact with fixed objects (exposed beams, pipes, etc.) that strike the top of the head to reduce the force of impact or penetration. Type I does not include a chin strap test or specification requirements.

TYPE II

Protect both the top and the sides of the head by incorporating a foam liner designed to absorb the force of impact with the head form swiveled at 60° in any direction so that the point of impact is off center.

STANDARD	TYPE	CROWN IMPACT	SIDE IMPACT	PENETRATION	IMPACT ABSORPTION
ANSI Z89.1	Type I	●		2.2 lbs. at 23 ft/s	8 lbs. at 18 ft/s
ANSI Z89.1	Type II	●	●	2.2 lbs. at 23 ft/s	8 lbs. at 18 ft/s



WORKING
AT HEIGHT



TRIP
AND FALL



STRUCK-BY
HAZARDS



BUMPING
INTO

ELECTRICAL CLASSES

Three classes indicate the helmet's electrical insulation rating.



CLASS E ELECTRICAL

Non-vented, reduces the danger of contact with high voltage risks, proof tested at 20,000 volts



CLASS G GENERAL

Non-vented, reduces the danger of low voltage risks, proof tested at 2,200 volts



CLASS C CONDUCTIVE

Vented, provides no electrical protection



EXTREME PERFORMANCE HEAT RESISTANCE

Certain shell materials are designed to protect for high heat, tested for several hours to maintain comfortable temperatures for workers in sustained high temperature environments.



HARD HAT

Most common form of head protection, with Type I Class E (non-vented) as the most widely specified hard hat style. Features include a secure and adjustable suspension with a robust wheel ratchet to properly adjust fit.

SAFETY HELMET

Safety helmets are a relatively new concept in industrial and construction settings. Safety helmets feature an adjustable multi-point chin strap designed to keep the hard hat on the head in the event of a fall with a short brim design for unobstructed peripheral vision.

ANSI Z89.1 Type II rated head protection offers the highest level of side-impact and penetration protection, designed with foam inserts that reduce the force of impact from a blow to the top, front, back and sides of the head. Transmitted force through the head form cannot exceed 4.45kN / 1000 lbf.

BUMP CAPS

Bump caps are designed to help protect against minor incidents such as bumping into or knocking against a stationary object. They are not ANSI approved to protect against falling objects or projectiles. Environments with low ceilings or hanging obstructions that the worker might bump into or those where hard hats are not mandatory are ideal places to wear bump caps.



SAFETY HELMETS

Working At Height



CONSTRUCTION, INDUSTRIAL & UTILITIES

Wind Energy / Scaffolding / Telecom / Utilities



Scan it

PREMIUM COMFORT + EYE & FACE PROTECTION

JSP® EVO® VISTAlens™ Ascend® 280-EVLV-CH

- Fully adjustable 4 point chin strap
 - Adjustable integrated eye protection
 - ANSI Type I; Class C
- Tested to mandatory EN 12492 shock and penetration requirements*

AVAILABLE COLORS



▲ 280-EVSV-CH

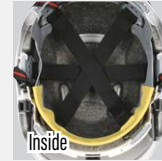

▲ 280-EVLV-CH

JSP® EVO® VISTashield™ Ascend® 280-EVSV-CH

- Fully adjustable 4 point chin strap
 - Adjustable integrated face protection
 - ANSI Type I; Class C
- Tested to mandatory EN 12492 shock and penetration requirements*

AVAILABLE COLORS



LIGHT, VERSATILE & COMFORTABLE

JSP® EVO® 6151 Ascend® 280-EV6151S-CH

- Short brim shell with 4-point chin strap
 - Shock absorbing EPS liner
 - ANSI Type I; Class E or C
- Tested to mandatory EN 12492 shock and penetration requirements*

AVAILABLE COLORS



▲ 280-EV6161-CH

▲ 280-EV6151SV-CH

JSP® EVO® 6161 Ascend® 280-EV6161-CH

- Full brim shell with 4-point chin strap
 - Shock absorbing EPS liner
 - ANSI Type I; Class E or C
- Tested to mandatory EN 12492 shock and penetration requirements*

AVAILABLE COLORS





DYNAMIC ALL-AROUND PROTECTION

Dynamic® Rocky™ 280-HP142

- Super lightweight ABS/Polycarbonate shell
- Foam lateral impact protection
- ANSI/CSA Type II; Class E

POPULAR COLORS



Added side
impact protection



SUPER LIGHTWEIGHT
POLYCARBONATE/ABS SHELL

INTEGRATED HIGH-DENSITY
INNER SHELL FOAM LINER

ADJUSTABLE 4-POINT
SUSPENSION, WITH SURE-LOCK
WHEEL RATCHET & CHIN STRAP

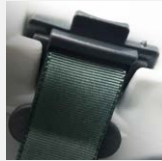

4-point quick-release suspension for a proper fit



Inner padding for added comfort



Accessory slots

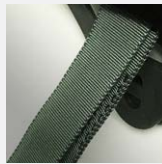

Double-layer textile straps for a secure fit



Sure-lock wheel ratchet for an effortless fit

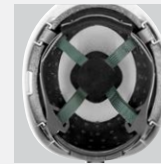

Impact liner helps absorb front, side, or rear impacts

JSP® EVO® VISTA ^{lens} ™ Ascend*			STANDARDS MET		SHELL MATERIAL	SUSPENSION	SIZE ADJUSTMENT	BRIM	OPTIONS	AVAILABLE COLORS	PROP 65
STYLE NUMBER	CLASS	TYPE	ANSI Z89.1	CSA Z94.1-15							
280-EVLV-CH	Class C (VENTED)	Type I	•		ABS	6-Point Polyester Textile	Wheel Ratchet	Short	Integrated eye protection	White/White, White/Smoke, Black/Smoke/Silver CR2	⚠ ^R
JSP® EVO® VISTA ^{shield} ™ Ascend*											
280-EVSV-CH	Class C (VENTED)	Type I	•		ABS	6-Point Polyester Textile	Wheel Ratchet	Short	Integrated eye protection	White/White, White/Smoke, Black/Smoke/Silver CR2	⚠ ^R
JSP® EVO® 6161 Ascend*											
280-EV6161-CH	Class E (NON-VENTED)	Type I	•		HDPE	6-Point Polyester Textile	Wheel Ratchet	Full	Evospec compatible	White, Yellow, Black	⚠ ^R
280-EV6161V-CH	Class C (VENTED)	Type I	•		HDPE	6-Point Polyester Textile	Wheel Ratchet	Full	Evospec compatible	White, Yellow, Black	⚠ ^R
JSP® EVO® 6151 Ascend*											
280-EV6151S-CH	Class E (NON-VENTED)	Type I	•		HDPE	6-Point Polyester Textile	Wheel Ratchet	Short	Evospec compatible	White, Yellow, Black	⚠ ^R
280-EV6151SV-CH	Class C (VENTED)	Type I	•		HDPE	6-Point Polyester Textile	Wheel Ratchet	Short	Evospec compatible	White, Yellow, Black	⚠ ^R
Dynamic® Rocky™											
280-HP142R	Class E (NON-VENTED)	Type II	•	•	ABS/polycarbonate	4-Point Nylon	Wheel Ratchet	Short	Foam Lateral Protection	White, Yellow, Orange, Green, Light Blue, Gray, Black, Red	

C = ⚠^R WARNING: Cancer - www.P65Warnings.ca.gov

R = ⚠^R WARNING: Reproductive Harm - www.P65Warnings.ca.gov

C&R = ⚠^R WARNING: Cancer and Reproductive Harm - www.P65Warnings.ca.gov



HARD HATS

Heavy-Duty



Scan it



INDUSTRIAL, CONSTRUCTION & UTILITIES

Mining / Tunneling / Demolition / Utilities / Metal Work



HIGH-QUALITY FIBERGLASS RESIN SHELL WITHSTANDS HEAT

Dynamic® Wolfjaw™ 280-HP1481R

- Lightweight fiberglass shell
- Radiant heat protection up to 350°F
- Wheel ratchet size adjustment
- ANSI Type I; Class G

POPULAR COLORS



LIGHTWEIGHT
FIBERGLASS
RESIN SHELL



8-POINT RIVET
SUSPENSION WITH
A THREE-POSITION
HEIGHT ADJUSTMENT

PREMIUM ALL-AROUND PROTECTION

JSP® MK8 Evolution® 280-AHS150

- High strength outer shell
- Premium lateral impact protection
- ANSI Type II; Class E or C

JSP® MK8 Evolution® Linesman 280-AHS240

- High strength outer shell with chin strap
- Premium lateral impact protection
- ANSI Type II; Class E or C

AVAILABLE COLORS



▲ 280-AHS150



280-AHS240 ▲



DYNAMIC
FLUID STYLING



**Dynamic[®]
Cotopaxi™
280-HP441R**

- Lightweight polycarbonate/ABS shell
- Wheel ratchet size adjustment
- ANSI/CSA Type I; Class E

POPULAR COLORS



DYNAMIC
ALL-AROUND PROTECTION



**Dynamic[®]
Mont-Blanc™
280-HP542R**

- Lightweight HDPE shell
- Foam lateral impact protection
- ANSI/CSA Type II; Class E

POPULAR COLORS



DYNAMIC
ELEVATED HEAT PERFORMANCE



**Dynamic[®]
Vesuvio™
280-HP851**

- Ambient heat protection up to 400°F
- Wheel ratchet size adjustment
- ANSI/CSA Type I; Class E

POPULAR COLORS



DYNAMIC
TOUGH ABS/POLYCARBONATE SHELL



**Dynamic[®]
Stroboli™
280-HP841**

- ABS/Polycarbonate shell with matte finish
- Wheel ratchet or swing ratchet adjustment
- ANSI/CSA Type I or 2; Class E

POPULAR COLORS



Dynamic [®] Wolfjaw™			STANDARDS MET								
STYLE NUMBER	CLASS	TYPE	ANSI Z89.1	CSA Z94.1-15	SHELL MATERIAL	SUSPENSION	SIZE ADJUSTMENT	BRIM	OPTIONS	AVAILABLE COLORS*	PROP 65
280-HP1481R	Class G (NON-VENTED)	Type I	•		Fiberglass Resin	8-Point Riveted Textile	Wheel Ratchet	Full Brim	Radiant heat protection up to 350°F	White, Yellow, Black, Natural	
JSP [®] MK8 Evolution™											
280-ANS150	Class E (NON-VENTED)	Type II	•		HDPE	6-Point Polyester Textile	Wheel Ratchet	Standard	High Strength Outer Shell	White, Yellow, Blue	⚠️ R
280-ANS150V	Class C (VENTED)	Type II	•		HDPE	6-Point Polyester Textile	Wheel Ratchet	Standard	High Strength Outer Shell	White	⚠️ R
JSP [®] MK8 Evolution™ Linesman											
280-ANS240	Class E (NON-VENTED)	Type II	•		HDPE	6-Point Polyester Textile	Wheel Ratchet	Standard	High Strength Outer Shell with Chinstrap	White, Yellow, Blue	⚠️ R
280-ANS240V	Class C (VENTED)	Type II	•		HDPE	6-Point Polyester Textile	Wheel Ratchet	Standard	High Strength Outer Shell with Chinstrap	White	⚠️ R
Dynamic [®] Cotopaxi™											
280-HP441R	Class E (NON-VENTED)	Type I	•	•	ABS/Polycarbonate	4-Point Nylon	Wheel Ratchet	Standard	Durable Polycarbonate/ABS Shell	Gray, Red, Lime Green, Steel Blue	
Dynamic Mont-Blanc™											
280-HP542	Class E (NON-VENTED)	Type II	•	•	HDPE	4-Point Nylon	Wheel Ratchet	Standard	Foam/Lateral Impact Protection	White, Dark Green, Hi-Vis Yellow, Hi-Vis Orange	
Dynamic [®] Vesuvio™											
280-HP851	Class E (NON-VENTED)	Type I	•		Nylon Resin	4-Point Nylon	Wheel Ratchet	Standard	Ambient heat protection up to 400°F	Gray, Black, Dark Gray, Steel Blue	
Dynamic [®] Stroboli™											
280-HP841R	Class E (NON-VENTED)	Type I	•	•	ABS/Polycarbonate	4-Point Nylon	Wheel Ratchet	Standard	High Strength Outer Shell with Matte Finish	White, Yellow, Orange, Gray, Red	
280-HP841SR	Class E (NON-VENTED)	Type I	•	•	ABS/Polycarbonate	4-Point Nylon	Wheel Ratchet	Standard	High Strength Outer Shell with Matte Finish	White, Yellow, Orange, Gray, Red	
280-HP842R	Class E (NON-VENTED)	Type II	•	•	ABS/Polycarbonate	4-Point Nylon	Swing Wheel Ratchet	Standard	High Strength Outer Shell with Matte Finish	White, Yellow, Orange, Gray, Red	

C = ⚠️ WARNING: Cancer - www.P65Warnings.ca.gov R = ⚠️ WARNING: Reproductive Harm - www.P65Warnings.ca.gov C&R = ⚠️ WARNING: Cancer and Reproductive Harm - www.P65Warnings.ca.gov

* View all Dynamic[®] color options at pjpusa.com



CAP STYLE HARD HATS

General



Scan it



CONSTRUCTION & INDUSTRIAL

Building Construction / Roadwork / Excavation / General Industrial



TOP-SELLING ENGINEERED PERFORMANCE



Dynamic® Whistler™ 280-HP241

- Classic cap styling
- Wheel ratchet or pin lock size adjustment
- ANSI/CSA Type I; Class E or C

POPULAR COLORS



Enhanced strength and protection



Maximum force absorption without sacrificing worker comfort

Highly adjustable 4-point nylon inner suspension features a plush brow pad, comfortable crown padding and soft inside ratchet foam.

Suspension is available with economical pin-lock or with our exclusive SURE-LOCK one-handed wheel ratchet adjustment that provides an easy-to-use, secure fit.





DYNAMIC
VERSATILE
PROTECTION



Dynamic® Dom™
280-HP341

- Smooth dome shape
- Wheel ratchet or swing ratchet adjustment
- ANSI/CSA Type I; Class E

POPULAR COLORS



DYNAMIC
MODERN
STYLE



Dynamic® Tremblant™
280-HP741

- Curved and fluid style
- Wheel ratchet size adjustment
- ANSI/CSA Type I; Class E

POPULAR COLORS



DYNAMIC
SLEEK
DESIGN



Dynamic® Logan™
280-HP1141RSP

- Short brim for unobstructed view
- Lightweight high density polyethylene shell
- ANSI/CSA Type I; Class C or E
- ANSI/CSA Type II; Class C or E

POPULAR COLORS



Dynamic® Whistler™			STANDARDS MET							
STYLE NUMBER	CLASS	TYPE	ANSI Z89.1	CSA Z94.1-15	SHELL MATERIAL	SUSPENSION	SIZE ADJUSTMENT	BRIM	OPTIONS	AVAILABLE COLORS*
280-HP241	Class E (NON-VENTED)	Type I	•	•	HDPE	4-Point Nylon	Wheel Ratchet	Standard	-	White, Yellow, Orange, Gray, Red, Hi-Vis Orange, Hi-Vis Yellow
280-HP241R	Class E (NON-VENTED)	Type I	•	•	HDPE	4-Point Nylon	Wheel Ratchet	Standard	-	White, Yellow, Orange, Gray, Red, Hi-Vis Orange, Hi-Vis Yellow
280-HP241RV	Class C (VENTED)	Type I	•	•	HDPE	4-Point Nylon	Wheel Ratchet	Standard	-	White, Yellow, Orange, Gray, Red, Hi-Vis Orange, Hi-Vis Yellow
Dynamic® Dom™										
280-HP341R	Class E (NON-VENTED)	Type I	•	•	HDPE	4-Point Nylon	Swing Wheel Ratchet	Standard	-	White, Orange, Gray, Royal Blue
280-HP341SR	Class E (NON-VENTED)	Type I	•	•	HDPE	4-Point Nylon	Wheel Ratchet	Standard	-	White, Orange, Gray, Royal Blue
Dynamic® Tremblant™										
280-HP741R	Class E (NON-VENTED)	Type I	•	•	HDPE	4-Point Nylon	Wheel Ratchet	Standard	-	White, Yellow, Orange, Gray, Red, Hi-Vis Yellow
Dynamic® Logan™										
280-HP1141RSP	Class E (NON-VENTED)	Type I	•	•	HDPE	4-Point Nylon	Wheel Ratchet	Standard	-	White, Yellow, Orange, Gray, Red, Hi-Vis Orange, Hi-Vis Yellow
280-HP1141RSPV	Class C (VENTED)	Type I	•	•	HDPE	4-Point Nylon	Wheel Ratchet	Standard	-	White, Yellow, Orange, Gray, Red, Hi-Vis Orange, Hi-Vis Yellow
280-HP1142RSP	Class E (NON-VENTED)	Type II	•	•	HDPE	4-Point Nylon	Wheel Ratchet	Standard	-	White, Yellow, Orange, Gray, Red, Hi-Vis Orange, Hi-Vis Yellow
280-HP1142RSPV	Class C (VENTED)	Type II	•	•	HDPE	4-Point Nylon	Wheel Ratchet	Standard	-	White, Yellow, Orange, Gray, Red, Hi-Vis Orange, Hi-Vis Yellow

*View all Dynamic® color options at pipusa.com



NEXT GENERATION HARD HATS

JSP® EVO® VISTA^{lens}™ 280-EVLV

- Lightweight ABS shell
- Adjustable integrated eye protection
- ANSI Type I; Class C

JSP® EVO® VISTA^{shield}™ 280-EVSV-CH

- Lightweight ABS shell
- Adjustable integrated face protection
- ANSI Type I; Class C

AVAILABLE COLORS



▲ 280-EVLV



▲ 280-EVSV

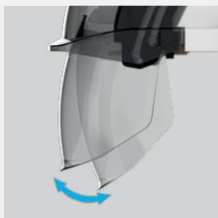

Fully adjustable and pivots smoothly

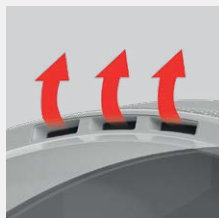

Dual vented shell for increased comfort

**OPTIONAL*

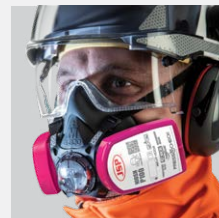

Compatible with a variety of other PPE



Maximum facial coverage



Integrated visor offers a panoramic view



Unrivaled comfort

JSP® EVO® VISTA^{lens}™

STANDARDS MET

STYLE NUMBER	CLASS	TYPE	ANSI Z89.1	CSA Z94.1-15	SHELL MATERIAL	SUSPENSION	SIZE ADJUSTMENT	BRIM	PREMIUM FEATURES	AVAILABLE COLORS	PROPS
280-EVLV	Class C (VENTED)	Type I	•	•	ABS	6-Point Polyester Textile	Wheel Ratchet	Short	Integrated Eye Protection	White/White, White/Smoke, Blue/Blue, Blue/Smoke	▲ ^R

JSP® EVO® VISTA^{shield}™

280-EVSV	Class C (VENTED)	Type I	•	•	ABS	6-Point Polyester Textile	Wheel Ratchet	Short	Integrated Eye & Face Protection	White/White, White/Smoke, Blue/Blue, Blue/Smoke	▲ ^R
----------	------------------	--------	---	---	-----	---------------------------	---------------	-------	----------------------------------	---	----------------

C = ▲ **WARNING:** Cancer - www.P65Warnings.ca.gov

R = ▲ **WARNING:** Reproductive Harm - www.P65Warnings.ca.gov

CR = ▲ **WARNING:** Cancer and Reproductive Harm - www.P65Warnings.ca.gov

EXTRA COVERAGE



JSP® Evolution® Deluxe 6151 280-EV6151

- 10% extra protection zone - standard brim
- Wheel ratchet size adjustment
- ANSI Type I; Class E or C

AVAILABLE COLORS



JSP® Evolution Deluxe Mining Hard Hat 280-EV6151M

- Designed for mining with a mining lamp bracket and cable loop

AVAILABLE COLORS



Extra Protection Zone

With the Evolution® design, we have introduced an **extra protection zone** on both the sides and the back of the hard hat. This provides the wearer with approximately **10% extra protection coverage** when compared to a standard hard hat design. This helps to protect areas of the head that would otherwise be exposed.

EXTRA PROTECTION ZONE

Approximately 10% extra protection on the sides and the back of the hard hat.



6-point suspension

6-point suspension system with polyester textile straps offers unrivaled comfort without compromising performance.



5 raised channels

Deliver enhanced strength and improved balance for a more comfortable user experience.

Five ridge helmet Design Patent D667,590

JSP® Evolution® Deluxe 6151			STANDARDS MET		SHELL MATERIAL	SUSPENSION	SIZE ADJUSTMENT	BRIM	OPTIONS	AVAILABLE COLORS	PROP 65
STYLE NUMBER	CLASS	TYPE	ANSI Z89.1	CSA Z94.1-15							
280-EV6151	Class E (NON-VENTED)	Type I	•		HDPE	6-Point Polyester Textile	Wheel Ratchet	Standard	-	White, Black, Yellow, Green, Pink, Gray, Blue, Red, Br. Lime	⚠️ ^R
280-EV6151V	Class C (VENTED)	Type I	•		HDPE	6-Point Polyester Textile	Wheel Ratchet	Standard	-	White, Yellow, Gray, Blue, Br. Lime, Br. Orange	⚠️ ^R
280-EV6151S	Class E (NON-VENTED)	Type I	•		HDPE	6-Point Polyester Textile	Wheel Ratchet	Short	-	White, Yellow	⚠️ ^R
280-EV6151SV	Class C (VENTED)	Type I	•		HDPE	6-Point Polyester Textile	Wheel Ratchet	Short	-	White, Yellow, Blue, Red	⚠️ ^R
JSP® Evolution® Deluxe Mining Hard Hat											
280-EV6151M	Class E (NON-VENTED)	Type I	•		HDPE	6-Point Polyester Textile	Wheel Ratchet	Standard	Non-Corrosive Steel Lamp Bracket	White, Yellow, Green, Blue, Red, Br. Lime, Br. Orange	⚠️ ^R
280-EV6151MCR2	Class E (NON-VENTED)	Type I	•		HDPE	6-Point Polyester Textile	Wheel Ratchet	Standard	CR2 Reflective Kit Pre-Installed	White, Yellow, Green, Blue, Red, Br. Lime, Br. Orange	⚠️ ^R

C = ⚠️ **WARNING:** Cancer - www.P65Warnings.ca.gov

R = ⚠️ **WARNING:** Reproductive Harm - www.P65Warnings.ca.gov

C&R = ⚠️ **WARNING:** Cancer and Reproductive Harm - www.P65Warnings.ca.gov



FULL BRIM HARD HATS

General



Scan it



CONSTRUCTION & INDUSTRIAL

Added protection from the elements



ENGINEERED PERFORMANCE



Dynamic® Kilimanjaro™ 280-HP641

- Sleek and attractive HDPE shell
- Wheel ratchet size adjustment
- 4-point suspension system
- ANSI/CSA Type I; Class E or C

POPULAR COLORS



WIDE PROFILE DESIGN



Dynamic® Annapurna™ 280-HP1041R

- Lightweight polycarbonate / ABS shell with matte finish
- Wheel ratchet size adjustment
- 4-point suspension
- ANSI/CSA Type I; Class E

POPULAR COLORS

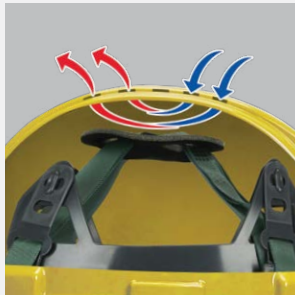

Vented shell

Optional cooling vents along the crown of the hard hat provides better comfort and cooling.



Longer back brim

Helps protect neck and ears from the sun's UV rays and functions as a run-off for rain and snow.

Dynamic® Annapurna™			STANDARDS MET		SHELL MATERIAL	SUSPENSION	SIZE ADJUSTMENT	BRIM	OPTIONS	AVAILABLE COLORS*
STYLE NUMBER	CLASS	TYPE	ANSI Z89.1	CSA Z94.1-15						
280-HP1041R	Class E (NON-VENTED)	Type I	•	•	ABS/Polycarbonate	4-Point Nylon	Wheel Ratchet	Full Brim	-	White, Yellow, Orange, Dark Green, Gray, Beige, Black, Gold, Red, Lime Green, Steel Blue, Forest Green
Dynamic® Kilimanjaro™					SHELL MATERIAL	SUSPENSION	SIZE ADJUSTMENT	BRIM	OPTIONS	AVAILABLE COLORS*
STYLE NUMBER	CLASS	TYPE	ANSI Z89.1	CSA Z94.1-15						
280-HP641	Class E (NON-VENTED)	Type I	•	•	HDPE	4-Point Nylon	Pin Lock	Full Brim	-	White, Yellow, Orange, Gray, Red, Hi-Vis Orange, Hi-Vis Yellow
280-HP641R	Class E (NON-VENTED)	Type I	•	•	HDPE	4-Point Nylon	Wheel Ratchet	Full Brim	-	White, Yellow, Orange, Gray, Red, Hi-Vis Orange, Hi-Vis Yellow
280-HP641RV	Class C (VENTED)	Type I	•	•	HDPE	4-Point Nylon	Wheel Ratchet	Full Brim	-	White, Yellow, Orange, Gray, Red, Hi-Vis Orange, Hi-Vis Yellow
280-HP642R	Class E (NON-VENTED)	Type II	•	•	HDPE	4-Point Nylon	Wheel Ratchet	Full Brim	-	White, Yellow, Orange, Gray, Red, Hi-Vis Orange, Hi-Vis Yellow

*View all Dynamic® color options at pipusa.com

PREMIUM DESIGN



**JSP® Evolution®
Deluxe 6161
280-EV6161**

- Popular style for outdoor work
- Wheel ratchet size adjustment
- 6-point suspension system
- ANSI Type I; Class E or C

AVAILABLE COLORS



**JSP® Evolution®
Deluxe Mining Hard Hat
280-EV6161M**

- Wheel ratchet size adjustment
- ANSI Type I; Class E

AVAILABLE COLORS

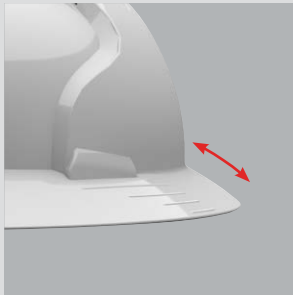





Shorter front brim

Shades the face while allowing excellent visibility.





Textured underside

Helps reduce reflection and glare off the brim.

JSP® Evolution® Deluxe 6161			STANDARDS MET		SHELL MATERIAL	SUSPENSION	SIZE ADJUSTMENT	BRIM	OPTIONS	AVAILABLE COLORS	PROP 65
STYLE NUMBER	CLASS	TYPE	ANSI Z89.1	CSA Z94.1-15							
280-EV6161	Class E (NON-VENTED)	Type I	•		HDPE	6-Point Polyester Textile	Wheel Ratchet	Full Brim	-	White, Yellow, Green, Blue, Red, Br. Lime, Br. Orange	 ^R
280-EV6161V	Class C (VENTED)	Type I	•		HDPE	6-Point Polyester Textile	Wheel Ratchet	Full Brim	-	With CR2 details: White, Yellow, Green, Blue, Red, Br. Orange	 ^R
JSP® Evolution® Deluxe Mining Hard Hat			STANDARDS MET		SHELL MATERIAL	SUSPENSION	SIZE ADJUSTMENT	BRIM	OPTIONS	AVAILABLE COLORS	PROP 65
STYLE NUMBER	CLASS	TYPE	ANSI Z89.1	CSA Z94.1-15							
280-EV6161M	Class E (NON-VENTED)	Type I	•		HDPE	6-Point Polyester Textile	Wheel Ratchet	Full Brim	Non-Corrosive Steel Lamp Bracket	White, Yellow, Green, Blue, Red, Br. Lime, Br. Orange	 ^R
280-EV6161MCR2	Class E (NON-VENTED)	Type I	•		HDPE	6-Point Polyester Textile	Wheel Ratchet	Full Brim	CR2 Reflective Kit Pre-Installed	White, Yellow, Green, Blue, Red, Br. Lime, Br. Orange	 ^R

C =  **WARNING:** Cancer - www.P65Warnings.ca.gov

R =  **WARNING:** Reproductive Harm - www.P65Warnings.ca.gov

C&R =  **WARNING:** Cancer and Reproductive Harm - www.P65Warnings.ca.gov



BUMP CAPS

Prevent Bumps & Scrapes



Scan it



USE IN WORK SPACES WHERE
HARD HATS ARE NOT MANDATED

Assembly Line / Maintenance / Aviation / Automotive



IDEAL FOR USE IN CONFINED SPACES

JSP® HardCap A1+™ Bump Cap 282-AB

- Sleek low profile baseball cap design
- HDPE liner provides all around protection
- Unique size adjuster provides a quick, secure fit



▲ REGULAR BRIM - 2.75"
282-ABR170



▲ SHORT BRIM - 2"
282-ABS150



▲ MICRO BRIM - 1"
282-ABM130



Low profile design

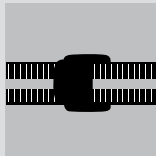

Unique size adjuster



Reflective piping



All-around protection



Sweatband



Ventilation

EXCELLENT COMFORT AND FIT

JSP® HardCap Aerolite™ Bump Cap

282-AES150 / 282-AEM130

- Lightweight and cool, weighs less than 5 oz.
- Sleek low profile baseball cap design
- HDPE liner provides all around protection
- Unique size adjuster provides a quick, secure fit



▲ **SHORT BRIM - 2"**
282-AES150



▲ **MICRO BRIM - 1"**
282-AEM130



Dynamic® Grand Slam™ 282-HP946

- Ideal for low hazard areas for protection against bumps and lacerations
- Interior shell with crown padding for comfort and fit
- Lightweight and well ventilated
- Adjustable sizing to fit most head sizes



JSP® HardCap Ranger Bump Cap 282-AFB375

- Shades the sun's UV rays
- 3" wide full brim

CLIP-ON LED CAP LIGHT



281-CAP-LED

- Securely clips onto brim of HardCap Bump Cap
- Includes 5 high-power white LEDs that are unbreakable

Batteries included

Bump Caps and Bump Cap Accessories

STYLE NUMBER	BRIM	AVAILABLE COLORS
280-HP940	Micro - 1.25"	White, Yellow, Dark Green, Sky Blue, Red
282-ABR170	Regular - 2.75"	Black, Gray, Orange, Navy, Yellow, Red, Camo, Hi-Vis Yellow, Hi-Vis Orange
282-ABS150	Short - 2"	Black, Gray, Navy, Yellow, Red, Camo, Hi-Vis Yellow, Hi-Vis Orange
282-ABM130	Micro - 1"	Black, Gray, Navy
282-AES150	Regular - 2"	Black, Navy
280-AEM130	Micro - 1"	Black, Navy
282-AFB375	Full Brim - 3"	Navy, Hi-Vis Yellow
282-HP946	Regular - 2.75"	Navy Blue, Gray, Black, Red-Custom Order
281-CAP-LED	Clip-On	Black



Scan it

Dynamic[®]

ACCESSORIES



280-HPSLH

Rocky™ Lamp/Goggle Clip

- 4 clips per pack
- Holds the lamp strap in place



- Compatible with Dynamic® Rocky™ and most styles of hard hats



280-HP241C

2-point, elastic with plastic hooks

Chin Straps

- Made to hold the hard hat on the head of the user
- 10 per pack



280-HP542C

4-point, elastic with plastic hooks

- Adjustable



280-HP142RS

Replacement Suspension

- Fits Dynamic® Rocky™ Climbing Helmet



280-HP641RS

Replacement Suspension

- Fits Dynamic® Style Hard Hats



280-HP142FM

Replacement Foam Liner

- Fits Dynamic® Rocky™ Climbing Helmet



280-HP542FM

Replacement Foam Liner

- Fits Dynamic® Style Hard Hats



280-HP1X4

Dyna-Lite™ Reflective Strips

- For Dynamic® hard hats
- Available in white, yellow and orange
- 16 strips per pack

STYLE NUMBER	DESCRIPTION	PROP 65
280-HPSLH	Rocky™ Lamp/Goggle Clip	-
280-HP241C	Chin Strap 2-Point	-
280-HP542C	Chin Strap 4-Point	-
280-HP142RS	Dynamic® Rocky Replacement Suspension HP142/R	⚠️ ^R
280-HP641RS	Dynamic® Style Hard Hats	⚠️ ^R
280-HP542RS	Dynamic® 280-HP542R, 280-HP642R, 280-HP842R	⚠️ ^R
280-HP641S	Dynamic® 280-HP241, 280-HP641	⚠️ ^R
280-HP741RS	Dynamic® 280-HP741R, 280-HP141RSP	⚠️ ^R
280-HP742RS	Dynamic® 280-HP142RSP	⚠️ ^R
280-HP841SRS	Dynamic® 280-HP341SR, 280-HP841SR	⚠️ ^R
280-HP58241	Replacement Felt Sweatband	-
280-HP142FM	Replacement Foam Liner	-
280-HP542FM	Replacement Foam Liner	-
280-HP1X4-01	Dyna-Brite™ Reflective Kits -White	-
280-HP1X4-02	Dyna-Brite™ Reflective Kits -Yellow	-
280-HP1X4-03	Dyna-Brite™ Reflective Kits -Orange	-

R=⚠️WARNING: Reproductive Harm - www.P65Warnings.ca.gov



Dynamic[®]

HARD HAT COLORS



PRODUCT FAMILY	STYLE NUMBER	White (40)	Yellow (42)	Orange (43)	Dark Green (44)	Hi-Vis Red (45)	Light Blue (46)	Sky Blue (47)	Navy Blue (48)	Gray (49)	Beige (10)	Black (11)	Gold (12)	Dark Gray (14)	Red (15)	Royal Blue (17)	Northern Blue (18)	Pink (20)	Hi-Vis Orange (30)	Hi-Vis Yellow (44)	Lime Green (45)	Steel Blue (70)	Forest Green (71)	Natural Brown (80)
Rocky [™]	280-HP142R	■	■	■	■		■			■		■			■									
Mont-Blanc [™]	280-HP542R	■	■	■	■				■	■				■	■									
Cotopaxi [™]	280-HP441R	■	■	■	■					■	■	■	■		■						■	■	■	
Vesuvio [™]	280-HP851R	■	■	■						■		■		■	■							■		
Stomboli [™]	280-HP841R	■	■	■	■					■		■		■	■						■	■	■	
	280-HP841SR	■	■	■						■		■		■	■						■	■	■	
	280-HP842R	■	■	■	■					■		■		■	■						■	■	■	
Whistler [™]	280-HP241	■	■	■	■	■			■	■	■			■	■	■			■	■				
	280-HP241R	■	■	■	■	■			■	■	■			■	■	■	■	■	■	■				
	280-HP241RV	■	■	■	■	■			■	■	■			■	■	■	■	■	■	■				
Dom [™]	280-HP341R	■	■	■	■			■	■	■	■			■	■	■						■	■	
	280-HP341SR	■	■	■	■			■	■	■	■			■	■	■						■	■	
Tremblant [™]	280-HP741R	■	■	■	■			■	■		■			■	■					■				
Logan [™]	280-HP1141RSP	■	■	■	■	■	■	■	■	■	■	■	■	■	■	■	■	■	■	■	■	■	■	■
	280-HP1141RSPV	■	■	■	■	■	■	■	■	■	■	■	■	■	■	■	■	■	■	■	■	■	■	■
	280-HP1142RSP	■	■	■	■	■	■	■	■	■	■	■	■	■	■	■	■	■	■	■	■	■	■	■
	280-HP1142RSPV	■	■	■	■	■	■	■	■	■	■	■	■	■	■	■	■	■	■	■	■	■	■	■
Anapura [™]	280-HP1041R	■	■	■	■					■	■	■	■		■						■	■	■	
Kilimanjaro [™]	280-HP641	■	■	■	■				■	■					■						■			
	280-HP641R	■	■	■	■			■	■	■				■	■	■					■	■		
	280-HP641RV	■	■	■	■			■	■	■				■	■	■					■	■		
	280-HP642R	■	■	■	■				■	■				■	■									
Wolfjaw [™]	280-HP1481R	■	■									■												■



Scan it

JSP® ACCESSORIES



281-CR2 *Cap Style*



281-CR2FB *Full Brim*

CR2 Reflective Decal Kits

- Upon application the hard hat will have 360° reflective coverage



250-EVS

EVOSpec™ Integrated Eyewear

- Retracts into helmet shell when not in use



281-CL-SET

Lamp & Goggle Clip Set

- Contains 2 side clips and 2 rear clips



281-SB-CHN



281-SB-NBF

Replacement Sweatbands



251-01-6225

Surefit™ Hard Hat Adapter

- Meets ANSI Z87+ requirements when worn with safety glasses or goggles



251-01-6201 *Polycarbonate* 251-01-6211 *Acetate*

Surefit™ Safety Visor

- Available in clear polycarbonate and acetate



280-6151-SUSP

Replacement Suspension

- For Evolution® Deluxe 6151 and 6161 Hard Hats



280-AHS-SUSP

Replacement Suspension

- For MK8 Evolution® Hard Hats



251-EVSR-0020

Replacement Lens

- For EVO® VISTAshield™



251-EVLR-0020

Replacement Lens

- For EVO® VISTAens™



281-CS-2PT *2-Point*
281-CSD-2PT *2-Point*



281-CS-4PT *4-Point*

Chin Straps

- Standard 2-point and adjustable 4-point elastic chin straps are compatible with Evolution® 6100 series hard hats and EVO® Vista™ style safety helmets.

Not compatible with Ascend® series safety helmets



281-SSE-CAP *Cap Style*



281-SSE-FB *Full Brim*

Sun Shade Extensions

- Extends the brim all the way around to help protect the wearer's ears and neck from the sun's rays

STYLE NUMBER	DESCRIPTION	PROP 65
281-CR2	Reflective Kit Cap Style JSP® Evolution®	-
281-CR2FB	Reflective Kit Full Brim JSP® Evolution®	-
281-CR2SW	Full Brim JSP® Skyworker®	-
281-EVCR2-10	Silver Reflective Kit EVO® Vista™	-
250-EVS	EVOSpec™ Integrated Eyewear	⚠️ R
281-CL-SET	Lamp/Goggle Clip	-
251-01-6225	JSP® Surefit™ Hard Hat Adapter	-
251-01-6201	JSP® Surefit™ Safety Visor Clear Polycarbonate	⚠️ R
251-01-6211	JSP® Surefit™ Safety Visor Clear Acetate	⚠️ R
281-SB-CHN	Replacement Sweatband for Evolution® Deluxe	-
281-SB-NBF	Replacement Sweatband for Evolution® 6121	-
280-6151-SUSP	Replacement Suspension for JSP® Evolution® 6151 or 6161	⚠️ R
280-AHS-SUSP	Replacement Suspension for JSP® MK8®	⚠️ R
281-CS-2PT	Chin Strap 2-Point Standard	-
281-CSD-2PT	Chin Strap 2-Point Deluxe	-
281-CS-4PT	Chin Strap 4-Point	-
281-SSE-CAP	Sunshade Extension Cap Style Hard Hats	-
281-SSE-FB	Sunshade Extension Full Brim Hard Hats	-
251-EVSR-0020	Anti-Fog/Anti-Scratch Lens for EVO® VISTAshield™ Helmet ANSI Z87.1	-
251-EVLR-0020	Anti-Fog/Anti-Scratch Lens for EVO® VISTAens™ Helmet ANSI Z87.1	-

R=⚠️ **WARNING:** Reproductive Harm - www.P65Warnings.ca.gov



JSP®

HARD HAT COLORS



PRODUCT FAMILY	STYLE NUMBER	White (-10)	Black (-11)	Yellow (-20)	Green (-30)	Pink (-39)	Gray (-40)	Blue (-50)	Red (-60)	Hi-Vis Yellow (-47)	Hi-Vis Orange (-46)	White/White (-81W)	White/Smoke (-40S)	Black/Smoke/Silver CR2 (-115B)	Blue/Blue (-50B)	Blue/Smoke (-50S)
EVO® 6161 Ascend™	280-EV6161-CH	■	■	■												
	280-EV6161V-CH	■	■	■												
EVO® 6151 Ascend™	280-EV6151-CH	■	■	■												
	280-EV6151SV-CH	■	■	■												
MK8 Evolution™	280-AHS150	■		■				■								
	280-AHS150V	■														
MK8 Evolution™ Linesman	280-AHS240	■		■				■								
	280-AHS240V	■														
MK8 Evolution™ Deluxe Mining Hard Hat	280-EV6151M	■	■		■			■	■	■	■					
	280-EV6151MCR2	■	■		■			■	■	■	■					
Evolution™ Deluxe 6151	280-EV6151	■	■	■	■	■	■	■	■	■						
	280-EV6151V	■	■				■	■		■	■					
	280-EV6151S	■	■													
	280-EV6151SV	■	■					■	■							
Evo6141	280-EV6141	■		■	■			■	■	■	■					
	280-EV6141V	■		■												
Evolution™ Deluxe 6161	280-EV6161	■		■	■		■	■	■	■	■					
	280-EV6161V	■		■	■		■	■	■	■	■					
Evolution™ Deluxe Mining Hard Hat	280-EV6161M	■		■	■		■	■	■	■	■					
	280-EV6161MCR2	■	■	■				■	■		■					
EVO® VISTA™ Ascend™	280-EVLV-CH										■	■	■			
EVO® VISTAshield™ Ascend™	280-EVSV-CH										■	■	■			
EVO® VISTA™ Ascend™	280-EVLV										■	■		■	■	
EVO® VISTAshield™ Ascend™	280-EVSV										■	■		■	■	



Scan it

Go-To-Work Kits

Choose from two hard hats:



Whistler™ Cap Style
280-HP241

OR

Kilimanjaro™ Full Brim
280-HP641



Packed and ready to wear

Bouton® Optical Zenon Z12™ Eyewear
250-01-0000
Black Temple/Clear Lens

G-Tek® Nylon Foam Nitrile Grip Gloves
34-C232
Gray Liner/Black Grip

Disposable Coded Ear Plugs
267-HPF210C
NRR 32 dB in hi-vis orange

ANSI Class 2 Value Mesh Vest
302-V100
Hi-Vis Lime Yellow



Grab, go and get to work!



STYLE NUMBER	HARD HAT	HARD HAT COLOR	GLOVES	VEST
289-GTW-HP241-M/L	Cap Style	White	M	L
289-GTW-HP241-M/L	Full Brim	White	M	L
289-GTW-HP241-L/XL	Cap Style	White	L	XL
289-GTW-HP641-L/XL	Full Brim	White	L	XL
289-GTW-HP641-XL/XXL	Cap Style	White	XL	XXL
289-GTW-HP641-XL/XXL	Full Brim	White	XL	XXL

Custom kits available



Flame Resistant Hoods

Scan it



NOMEX® FLAME RESISTANT HOODS

202-1

- Offer limited chemical splash protection along with excellent wear and durability
- Meets OSHA requirements for flame resistance
- Protective properties will not wash out
- All bibs are 6" front and back



▲ 202-130



▲ 202-101

STYLE NUMBER	COVERAGE	LAYER	BIB	COLOR	SIZES
202-100	Full Face	Single	Without	White	OSFM
202-101	Full Face	Single	Without	Black	OSFM
202-102	Full Face	Double	Without	White	OSFM
202-110	Full Face	Single	With	White	OSFM
202-112	Full Face	Double	With	White	OSFM
202-130	Slit Eye	Single	With	White	OSFM
202-132	Slit Eye	Double	With	White	OSFM

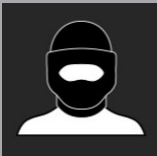

Full coverage keeps the face and neck protected.



Protective qualities will not wash out of Nomex® fabric.

Dual layer

Mesh inside



▲ 364-1195

PIP® Thermal Exo Balaclava

- Dual-layer balaclava provides form-fitting comfort and protection from extreme weather conditions sealing out the cold, wind and snow
- Harnesses heat from the sun's powerful solar rays to create an exothermic warming effect, intensifying the warming effect of the material up to 15° F (10°C)
- Soft, breathable mesh inner layer
- Wear as a neck gaiter or a full-face mask
- Lightweight fabric fits comfortably under a hard hat or helmet



▲ 364-1180

PIP® Value Winter Balaclava

- Protective wind-resistant fabric provides form-fitting comfort and protection from extreme weather conditions
- Soft, breathable mesh inner layer
- Can be worn in multiple ways: open face balaclava, neck gaiter or full-face mask
- Lightweight fabric fits comfortably under a hard hat or helmet
- Flexible material will stretch to fit most head sizes
- Machine washable

Winter Balaclavas

STYLE NUMBER	WASHES	MATERIAL	COLOR	LAYERS	SIZE
364-1195	Machine Washable	Polyester / Spandex	Black	2	OS
364-1180	Machine Washable	100% Polyester Fleece	Black	1	OS
395-250FR-B	Absorbitive Cooling	50% Meta-Aramid, 50% Lenzing FR, 220 gsm	Black	-	10"x20"



Scan it

Winter Liners



▲ **364-ML2MP**
Middy with Mouthpiece



▲ **364-1170**
3-in-1 Balaclava



▲ **365-1620**
Zip On/Off Extended Neck Liner

BEST SELLER

MATERIAL & CONSTRUCTION

Winter liners are available in 1, 2, or 3 layer constructions.

OUTER LAYERS



Cotton Twill



Polyester (Quilted)

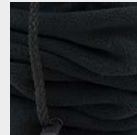

Polyester Fleece

INNER LAYERS



Fleece



Sherpa Pile
Fleece

LENGTHS



Regular Length (Shorty):
Hits at base of head



Mid-Length (Middy)
Hits just below nape of neck



Shoulder Length
(Extended):
Wraps around to front and can
be tucked into jacket

WARM

STYLE NUMBER	TYPE	LENGTH	COLOR	LAYERS	OUTER	MIDDLE	INNER
364-SL1FB	Non-FR	Extended	■ Navy	1	Fleece	-	-
363-1RL2B	1 Wash	Regular	■ Navy	2	Cotton Twill	-	Fleece
364-RL2B	30 Washes	Regular	■ Navy	2	Cotton Twill	-	Fleece

WARMER

364-1170	Non-FR	Extended Adjustable 3-in-1 Balaclava	■ Black	1	Polyester Fleece	-	-
363-1RL3QB	1 Wash	Regular - Quilted	■ Black	3	Polyester	Foam	Fleece
363-1ML2FB	1 Wash	Mid	■ Navy	2	Cotton Twill	-	Fleece
363-1SL2FB	1 Wash	Extended	■ Navy	2	Cotton Twill	-	Fleece
364-1RL3QB	10 Washes	Regular Quilted	■ Black	3	Polyester	Foam	Fleece
365-1620	10 Washes	Mid Zipper 2-in-1	■ Navy	2	Cotton Twill	Fleece	Acrylic Neck
364-ML2FB	30 Washes	Mid	■ Navy	2	Cotton Twill	-	Fleece
364-SL2FB	30 Washes	Extended	■ Navy	2	Cotton Twill	-	Fleece

WARMEST

364-ML2FMP	30 Washes	Mid - Mouthpiece	■ Navy	2	Cotton Twill	-	Fleece
364-ML2SB	30 Washes	Mid	■ Navy	2	Cotton Twill	-	Sherpa Pile
364-SL2SB	30 Washes	Extended	■ Navy	2	Cotton Twill	-	Sherpa Pile



FR Treated/Self-Extinguishing (Outer shells only):

Outer shell tested to retain their FR characteristics for 1, 10, or 30 washes.

Non-FR:

Hats, caps and a few select winter liners are not treated for use in applications that do not require the added protection.

SECTION:

Hearing Protection

Noise-Induced Hearing Loss Can Be Prevented

This section contains important PPE related to hearing protection. As many as 22 million Americans are exposed to potentially harmful noise at work. But, because hearing loss is gradual, many are unaware of the damage. For that reason, it's critical that hearing protection is used in industrial and construction settings.

All PIP® hearing protection carries a noise reduction rating (NRR) representing how much noise is reduced by the proper use of PPE. When choosing a device, it's important to select a product with an NRR that is appropriate for the environment in which it will be used. Comfort, ease of use and features are all key influencers when determining which hearing product is suitable.

COMPARING HEARING PROTECTION OPTIONS

Hearing protection comes in two formats. Ear Muffs help the wearer get maximum hearing protection because they seal against the head and cover the entire ear. Ear Plugs are more commonly used because they are considered more economical and the low profile means they can easily be worn with other PPE. However, the correct use of ear plugs is critical to their performance. PIP® recommends training and practice to ensure workers are using them properly.

PASSIVE EAR MUFFS

When choosing Passive Ear Muffs, consider the other PPE being worn. Neckband and cap mounted styles are designed to work with a hard hat, while headband style ear muffs, do not.

SINGLE-USE EAR PLUGS

Single-use Ear Plugs are the most popular choice – mostly for convenience and hygiene reasons. PIP® ear plugs with PowerSoft™ technology use a proprietary foam formulation for optimal rebound, a perfect fit and all-day comfort.

HYBRID EZ-TWIST™

The hybrid EZ-Twist™ technology eliminates the need for workers to roll down the ear plug before fitting; a unique stem makes great fit as easy as insert and twist.

MULTIPLE-USE EAR PLUGS

Multiple-use Ear Plugs are reusable and easy to clean, making them ideal for use in manufacturing, construction and MRO.

PIP® offers **Corded**, **Uncorded** and **Metal Detectable** options in both ear plug styles. Uncorded is economical, while corded plugs can be worn around the neck when not in use, making them easy to keep track of at all times. Metal detectable are preferred in food processing operations where X-rays may be used to confirm that nothing has contaminated the product.



CONTINUOUS
NOISE



SUDDEN BLASTS
OF NOISE



Scan it



PASSIVE Ear Muffs

FOR CONSTRUCTION, INDUSTRIAL AND ALL OTHER JOBS WHERE HEARING IS

HEADBAND

28
NRR



B52™
263-NP117

- Padded metal wire headband with micro-adjustment
- Extra-large earcups provide maximum noise protection
- Protection for high noise exposure

27
NRR



Hercules™
263-NP113

- Dielectric headband reduces electrical hazards
- Smooth telescopic height adjustment for optimized comfort and seal
- Protection for high noise exposure

25
NRR



Mirage™
263-NP115

- Padded metal wire headband with micro-adjustment
- Lightweight, low profile earcups
- Protection for moderate to high noise exposure

24
NRR



Spitfire™
263-NP111

- Dielectric headband reduces electrical hazards
- Smooth telescopic height adjustment for optimized comfort and seal
- Protection for moderate noise exposure

CAP STYLE HARD HAT MOUNT

25
NRR



**B52™
Cap Style**
263-NP118

- Durable metal wire headband with micro-adjustment
- Extra-large earcups provide maximum noise protection
- Multiple positions for usage, stand-by and storage
- Protection for moderate to high noise exposure

25
NRR



**Hercules™
Cap Style**
263-NP114

- Dielectric headband reduces electrical hazards
- Smooth telescopic height adjustment for optimized comfort and seal
- Multiple positions for usage, stand-by and storage
- Protection for high noise exposure

23
NRR



**Mirage™
Cap Style**
263-NP116

- Durable metal wire headband with micro-adjustment
- Lightweight, low profile earcups
- Multiple positions for usage, stand-by and storage
- Protection for moderate noise exposure

20
NRR



**Spitfire™
Cap Style**
263-NP112

- Dielectric headband reduces electrical hazards
- Smooth telescopic height adjustment for optimized comfort and seal
- Multiple positions for usage, stand-by and storage
- Protection from low noise exposure



AT RISK

25
NRR



Concorde™
263-NP121

- Collapsible design for convenient storage
- Lightweight, low profile earcups
- Protection for moderate to high noise exposure

24
NRR



Piper™
263-NP110

- Dielectric headband reduces electrical hazards
- Smooth telescopic height adjustment for optimized comfort and seal
- Protection for moderate noise exposure

BEHIND THE NECK

24
NRR



Mirage™
Neck Band
263-NP120

- Non-slip customizable strap adjustment
- Lightweight, low profile earcups
- Protection for moderate noise exposure

Can be worn with:
> Hard hats and other specialty headgear

FULL BRIM HARD HAT MOUNT

26
NRR



Buffalo™
Full Brim Style
263-NP119

- Durable metal wire headband with micro-adjustment
- Designed specifically for full brim hard hats
- Multiple positions for usage, stand-by and storage
- Protection for moderate to high noise exposure

Three distinct wearing positions:
> Over the ear
> Slightly off the ear
> Pivoted up when not in use

Maximum hearing protection

STYLE NUMBER	NRR	TYPE	DIELECTRIC	SIZE ADJUSTMENT	COLOR
263-NP110	24	Banded	Yes	Slide	Orange
263-NP111	24	Banded	Yes	Slide	Black/Blue
263-NP112	20	Cap Style	Yes	Slide	Black/Blue
263-NP113	27	Banded	Yes	Slide	Black/Green
263-NP114	25	Cap Style	Yes	Slide	Black/Green
263-NP115	25	Banded	No	Micro-Slide	Black/Yellow
263-NP116	23	Cap Style	No	Micro-Slide	Black/Yellow
263-NP117	28	Banded	No	Micro-Slide	Black/Red
263-NP118	25	Cap Style	No	Micro-Slide	Black/Red
263-NP119	26	Full Brim	No	Micro-Slide	Black/White
263-NP120	24	Neck Band	No	Adjustable Strap with Velcro	Black/Yellow
263-NP121	25	Folding Band	No	Micro-Slide	Black



Scan it

33
NRR
PLUS SERIES



SINGLE-USE
Ear Plugs

INCREASED SOUND PROTECTION



267-HPF810



267-HPF810C

33
NRR

Tapered shape for easy installation

Mega Bullet™ Plus

- Regular size fits most ear canals
- Easy roll-down for quick and easy insertion
- PowerSoft™ Foam Technology features a proprietary polyurethane formulation that delivers optimal recovery time, easy insertion and maximum all-day comfort
- Shape conforms to most ear canals for maximum sound attenuation



267-HPF910



267-HPF910C

33
NRR

Flared bell shape allows easier insertion and removal

Mega Flare™ Plus

- Design resists backing out of ear
- Non-irritating smooth outer surface
- PowerSoft™ Foam Technology features a proprietary polyurethane formulation that delivers optimal recovery time, easy insertion and maximum all-day comfort
- Shape conforms to most ear canals for maximum sound attenuation

Workers who need to block out loud noise demand the best protection and comfort available.

PIP® Plus Series ear plugs with PowerSoft™ polyurethane foam fit comfortably and securely in any ear canal providing increased 33 NRR sound attenuation.

Safeguard your hearing with a quick, consistent fit that eliminates any uncomfortable outward pressure.

STYLE NUMBER	NRR	USE	CORDING	MATERIAL	SIZE	SHAPE	COLOR	DETECTABLE	PAIR / PACK
Mega Bullet™ Plus									
267-HPF810	33	Single	Uncorded	PowerSoft™ Polyurethane Foam	Standard	Bullet	Orange	No	200 / Box
267-HPF810C	33	Single	Black PVC Cord	PowerSoft™ Polyurethane Foam	Standard	Bullet	Orange	No	100 / Box
Mega Flare™ Plus									
267-HPF910	33	Single	Uncorded	PowerSoft™ Polyurethane Foam	Standard	Contoured	Red	No	200 / Box
267-HPF910C	33	Single	Black PVC Cord	PowerSoft™ Polyurethane Foam	Standard	Contoured	Red	No	100 / Box



Scan it



DISPOSABLE EAR PLUGS

Metal Detectable

FOR FOOD PROCESSING FACILITIES

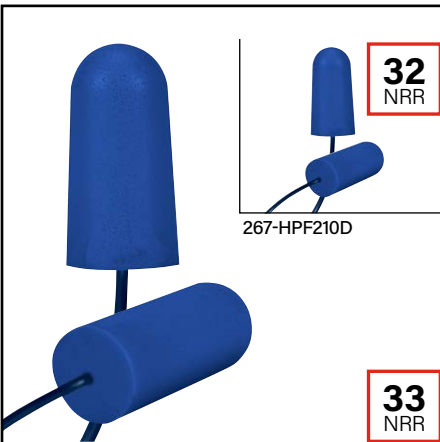

267-HPF210D

267-HPF810D

Tapered shape for easy installation

Mega Bullet™ and Food Pro Bullet™ Plus

- Regular size fits most ear canals
- Easy roll-down for quick and easy insertion
- PowerSoft™ Foam Technology features a proprietary polyurethane formulation that delivers optimal recovery time, easy insertion and maximum all-day comfort
- Shape conforms to most ear canals for maximum sound attenuation
- For use in the food industry



267-HPF910D

Flared bell shape allows easier insertion and removal

Food Pro Flare™ Plus

- Design resists backing out of ear
- Non-irritating smooth outer surface
- PowerSoft™ Foam Technology features a proprietary polyurethane formulation that delivers optimal recovery time, easy insertion and maximum all-day comfort
- Shape conforms to most ear canals for maximum sound attenuation



267-HPF610D

Hybrid foam plug and unique stem enable easy insertion

EZ-Twist™

- No need to roll down before fitting, ideal for use with dirty hands
- PowerSoft™ Foam Technology features a proprietary polyurethane formulation that delivers optimal recovery time, easy insertion and maximum all-day comfort
- Shape conforms to most ear canals for maximum sound attenuation
- For use in the food industry

STYLE NUMBER	NRR	USE	CORDING	MATERIAL	SIZE	SHAPE	COLOR	DETECTABLE	PAIR / PACK
Food Pro Bullet™ Plus									
267-HPF810D	33	Single	Metal Detectable Cord	PowerSoft™ Polyurethane Foam	Standard	Bullet	Blue	Yes	100 / Box
Mega Bullet™									
267-HPF210D	32	Single	Blue Metal Detectable Cord	PowerSoft™ Polyurethane Foam	Standard	Bullet	Blue	Yes	100 / Box
Food Pro Flare™ Plus									
267-HPF910D	33	Single	Metal Detectable Cord	PowerSoft™ Polyurethane Foam	Standard	Contoured	Blue	Yes	100 / Box
EZ-Twist™									
267-HPF610D	30	Single	Blue Metal Detectable Cord	PowerSoft™ Polyurethane Foam	Standard	Cylinder Push-In	Blue	Yes	100 / Box



Scan it



SINGLE-USE Ear Plugs

WITH POWERSOFT™ FOAM TECHNOLOGY



267-HPF210C

267-HPF210

32
NRR

**Tapered shape
for easy installation**

Mega Bullet™

- Regular size fits most ear canals
- Easy roll-down for quick and easy insertion
- PowerSoft™ Foam Technology features a proprietary polyurethane formulation that delivers optimal recovery time, easy insertion and maximum all-day comfort
- Shape conforms to most ear canals for maximum sound attenuation
- Traceable metal detectable (Blue) style available for use in the food industry



267-HPF310C

267-HPF310

28
NRR

**Smaller tapered shape designed
to fit narrow ear canals**

Nano Bullet™

- Designed to accommodate smaller ear canals
- Easy roll-down for quick and easy insertion
- Non-irritating smooth outer surface
- PowerSoft™ Foam Technology features a proprietary polyurethane formulation that delivers optimal recovery time, easy insertion and maximum all-day comfort



267-HPF410C

267-HPF410

32
NRR

**Flared bell shape allows easier
insertion and removal**

Mega Flare™

- Design resists backing out of ear
- Non-irritating smooth outer surface
- PowerSoft™ Foam Technology features a proprietary polyurethane formulation that delivers optimal recovery time, easy insertion and maximum all-day comfort
- Shape conforms to most ear canals for maximum sound attenuation

STYLE NUMBER	NRR	USE	CORDING	MATERIAL	SIZE	SHAPE	COLOR	DETECTABLE	PAIR / PACK
Mega Bullet™									
267-HPF210	32	Single	Uncorded	PowerSoft™ Polyurethane Foam	Standard	Bullet	Orange	No	200 / Box
267-HPF210C	32	Single	Black PVC Cord	PowerSoft™ Polyurethane Foam	Standard	Bullet	Orange	No	100 / Box
267-HPF210D	32	Single	Blue Metal Detectable Cord	PowerSoft™ Polyurethane Foam	Standard	Bullet	Blue	Yes	100 / Box
267-HPF210-1	32	Single - Dispenser Refill Pack	Uncorded	PowerSoft™ Polyurethane Foam	Standard	Bullet	Orange	No	250 / Box
Nano Bullet™									
267-HPF310	28	Single	Uncorded	PowerSoft™ Polyurethane Foam	Small	Bullet	Purple	No	200 / Box
267-HPF310C	28	Single	Black PVC Cord	PowerSoft™ Polyurethane Foam	Small	Bullet	Purple	No	100 / Box
267-HPF310-1	28	Single - Dispenser Refill Pack	Uncorded	PowerSoft™ Polyurethane Foam	Small	Bullet	Purple	No	250 / Box
Mega Flare™									
267-HPF410	32	Single	Uncorded	PowerSoft™ Polyurethane Foam	Standard	Contoured	Red	No	200 / Box
267-HPF410C	32	Single	Black PVC Cord	PowerSoft™ Polyurethane Foam	Standard	Contoured	Red	No	100 / Box
Dispenser									
267-HPD110		Wall Mount Dispenser							



PowerSoft™ Getting a proper fit

FOAM TECHNOLOGY

Foams with small, dense cells may result in:

- Harder plugs with shorter rebound time
- More pressure and discomfort in ear canal

Foams with large, airy cells may result in:

- Uneven roll-down and longer time to fit
- Longer rebound time

PIP® EAR PLUGS WITH POWERSOFT™
FOAM TECHNOLOGY DELIVER:

- Optimal rebound
- Maximum all-day comfort
- Perfect fit

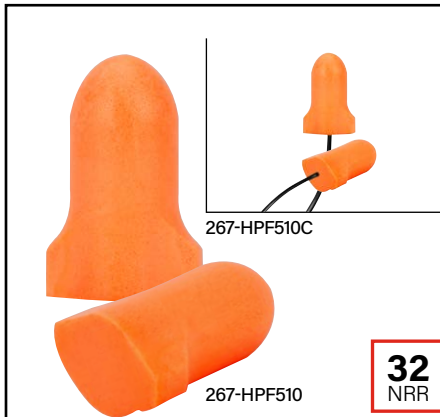
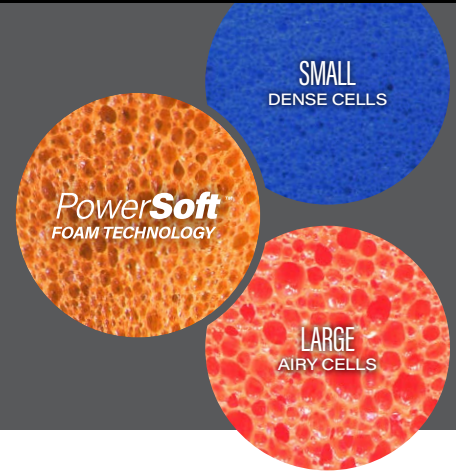

"T" shape is ideal for smaller or oval-shaped ear canals

Mega T-Fit™

- Wide base allows easier insertion and removal
- Design resists backing out of ear
- PowerSoft™ Foam Technology features a proprietary polyurethane formulation that delivers optimal recovery time, easy insertion and maximum all-day comfort
- Shape conforms to most ear canals for maximum sound attenuation

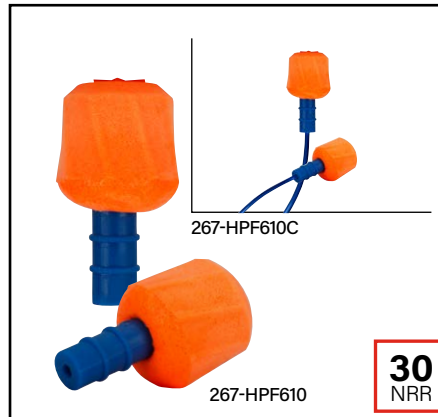

Hybrid foam plug and unique stem enable easy insertion

EZ-Twist™

- No need to roll down before fitting, ideal for use with dirty hands
- PowerSoft™ Foam Technology features a proprietary polyurethane formulation that delivers optimal recovery time, easy insertion and maximum all-day comfort
- Shape conforms to most ear canals for maximum sound attenuation
- Traceable metal detectable (blue) style available for use in the food industry

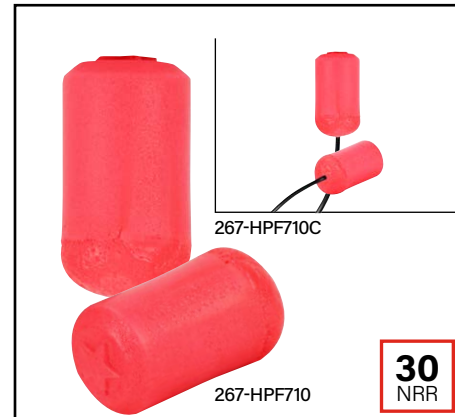

Softest most comfortable cylinder-shaped ear plug

SoftStar™

- Unique beveled edge helps insertion
- PVC* free PowerSoft™ Foam polyurethane foam
- PowerSoft™ Foam Technology features a proprietary polyurethane formulation that delivers optimal recovery time, easy insertion and maximum all-day comfort
- Shape conforms to most ear canals for maximum sound attenuation

* Most PVC formulations are listed as under Prop 65 as a controlled material

STYLE NUMBER	NRR	USE	CORDING	MATERIAL	SIZE	SHAPE	COLOR	DETECTABLE	PAIR / PACK
Mega T-Fit™									
267-HPF510	32	Single	Uncorded	PowerSoft™ Polyurethane Foam	Standard	T-Shaped	Orange	No	200 / Box
267-HPF510C	32	Single	Black PVC Cord	PowerSoft™ Polyurethane Foam	Standard	T-Shaped	Orange	No	100 / Box
EZ-Twist™									
267-HPF610	30	Single	Uncorded	PowerSoft™ Polyurethane Foam	Standard	Cylinder Push-In	Orange	No	200 / Box
267-HPF610C	30	Single	Black PVC Cord	PowerSoft™ Polyurethane Foam	Standard	Cylinder Push-In	Orange	No	100 / Box
267-HPF610D	30	Single	Blue Metal Detectable Cord	PowerSoft™ Polyurethane Foam	Standard	Cylinder Push-In	Blue	Yes	100 / Box
SoftStar™									
267-HPF710	30	Single	Uncorded	PowerSoft™ Polyurethane Foam	Small	Cylinder	Red	No	200 / Box
267-HPF710C	30	Single	Black PVC Cord	PowerSoft™ Polyurethane Foam	Small	Cylinder	Red	No	100 / Box



Scan it



MULTI-USE Ear Plugs



EASY TO CLEAN, REDUCE WASTE AND SAVE MONEY



27
NRR

267-HPR410



267-HPR410C

4-Flange Reusable

- Self-sealing 4 flange TPR (thermoplastic rubber) for all-day use and secure sound attenuation
- Corded version offers removable cord



25
NRR

267-HPR310

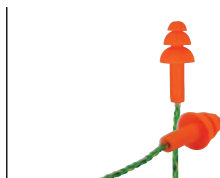

267-HPR310C

3-Flange Reusable

- Self-sealing 3-flange TPR (thermoplastic rubber) for all-day use and secure sound attenuation
- Corded version offers removable cord



27
NRR

267-HPR410D

METAL DETECTABLE

Metal Detectable 4-Flange Reusable

- Self-sealing 4 flange TPR (thermoplastic rubber) for all-day use and secure sound attenuation
- Metal detectable version offers metal infused ear plugs and cord for more detectability
- Metal detectable cord is NOT removable (used for food industry)

STYLE NUMBER	NRR	USE	CORDING	MATERIAL	SIZE	SHAPE	COLOR	DETECTABLE	PAIR / PACK
3-Flange Reusable									
267-HPR310	25	Reusable	Uncorded	TPR (thermoplastic rubber)	Standard	3-flange	Orange	No	200 / Box
267-HPR310C	25	Reusable	Textile Cord	TPR (thermoplastic rubber)	Standard	3-flange	Orange	No	100 / Box
4-Flange Reusable									
267-HPR410	27	Reusable	Uncorded	TPR (thermoplastic rubber)	Standard	4-flange	Red	No	200 / Box
267-HPR410C	27	Reusable	Textile Cord	TPR (thermoplastic rubber)	Standard	4-flange	Red	No	100 / Box
267-HPR410D	27	Reusable	Blue Metal Detectable Cord	TPR (thermoplastic rubber)	Standard	4-flange	Blue	Yes	100 / Box
267-HPR400C	27	Reusable	PVC Cord	TPR (thermoplastic rubber)	Standard	4-flange	Orange	No	100 / Box
267-HPR400D	27	Reusable	Blue Metal Detectable Cord	TPR (thermoplastic rubber)	Standard	4-flange	Orange	Yes	100 / Box

SECTION:

Respiratory Protection



PROVEN PROTECTION. PROVEN PERFORMANCE™.

This section of the catalog covers filtering facepiece respirators (FFR), commonly referred to as disposable respirators. These are designed to meet the National Institute for Occupational Safety and Health (NIOSH) requirements intended to help protect workers from airborne contaminants when working around particulate risks, filtering out between 95% to 99.97% of particles that are 0.3 microns in diameter or larger. PIP's line of Dynamic® filtering facepiece respirators are designed with advanced features for increased comfort and industrial wear and tear when working around the breathing hazards outlined below.



STANDARDS

The National Institute for Occupational Safety and Health (NIOSH) provides testing requirements for non-powered particulate filters that remove particulates from ambient air. NIOSH certifies three classes of filters with three levels of filter efficiency. PIP® carries the following classes of FFR for particulates:

N-SERIES

> **N95** – Operates with 95% efficiency

P-SERIES

> **P95** – Operates with 95% efficiency against oil-based particulates or aerosols

> **P100** – Operates with 99.97% efficiency against oil-based particulates or aerosols



WELDING FUMES



OIL-BASED PARTICULATES



PARTICULATES



Scan it



N95 Disposable Respirators

95% FILTRATION EFFICIENCY AGAINST NON-OIL BASED PARTICULATES



STANDARD N95 DISPOSABLE RESPIRATORS



270-RPD713N95



270-RPD714N95

- Durable, clear valve cover protects the butterfly valve and permits quick inspection to ensure the respirator valve is unobstructed and in proper working condition



FR OUTER LAYER MATERIAL

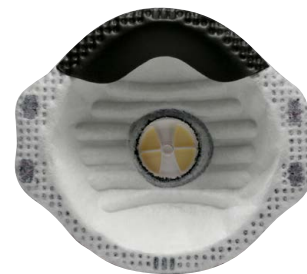

270-RPD714N950AO

- Activated carbon layer provides relief from nuisance levels of ozone, organic vapors or acid gases below PEL's

Dynamic® Standard N95 Disposable Respirators

NIOSH approved for at least 95% filtration efficiency against non-oil based particulates

- Closed-cell nose cushion provides a secure and comfortable seal
- Designed to be comfortable and compatible with safety eyewear and hearing protection
- Curved nose clip follows the contours of the user's nose for a superior seal at the bridge of the nose which helps minimize the fogging of eyewear
- Woven strap ultrasonically welded to the wings of the respirator
- Latex-free without any common allergens to keep you and your workers worry free

STYLE NUMBER	DESCRIPTION	PACK
270-RPD713N95	N95 Disposable Respirator	20 / Box
270-RPD714N95	N95 Disposable Respirator with Butterfly Valve	10 / Box
270-RPD714N950AO	N95 Disposable Respirator with Butterfly Valve, FR Material	10 / Box

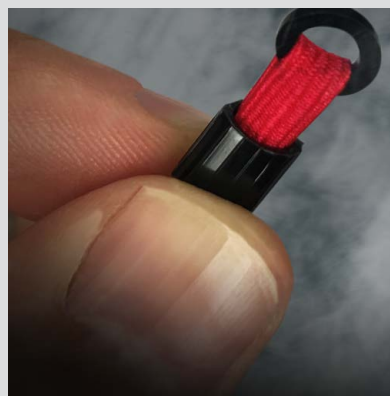

Adjustable toggle on straps provides a comfortable and custom fit



FLATFOLD N95 DISPOSABLE RESPIRATORS

Dynamic® Flatfold N95 Disposable Respirators

NIOSH approved N95 foldable respirator for filtration efficiency against non-oil based particulates

- Flatfold design is compact when not in use, increases worker productivity and can be kept in workers' pockets for future use
- Each respirator is individually wrapped for hygiene to ensure it's clean, safe and ready for use
- Latex-free, dual elastic head straps help keep the respirator positioned properly on the face
- Curved nose clip helps form the mask to the shape of the user's nose for a secure seal



Folds flat for easy storage



270-RPD723N95

270-RPD724N95
- Durable, valve cover protects the butterfly valve and permits quick inspection to ensure the respirator valve is unobstructed and in proper working condition

270-RPD725N95
- Vertical flat fold
- Adjustment toggle on both straps designed to achieve a secure, comfortable fit

STYLE NUMBER	DESCRIPTION	PACK
270-RPD723N95	N95 Flatfold Disposable Respirator	20 / Box
270-RPD724N95	N95 Flatfold Disposable Respirator with Butterfly Valve	10 / Box
270-RPD725N95	N95 Flatfold Disposable Respirator with Adjustable Strap	50 / Box



ECONOMY N95 DISPOSABLE RESPIRATORS

Dynamic® Economy N95 Disposable Respirators

NIOSH approved N95 respirator for filtration of non-oil particulates

- Open-cell foam nose pad creates a cushion between the nose and the mask for increased comfort
- Nose clip helps form the mask to the shape of the user's nose for a secure seal
- Latex-free

STYLE NUMBER	DESCRIPTION	PACK
270-RPD513N95	N95 Economy Disposable Respirator	20 / Box
270-RPD514N95	N95 Economy Disposable Respirator with Butterfly Valve	10 / Box



270-RPD513N95



270-RPD514N95

- Durable, clear shield protects the butterfly valve

Enhanced comfort and reliability when working around breathing hazards





Scan it



P95 Disposable Respirators

95% FILTRATION EFFICIENCY AGAINST OIL-BASED PARTICULATES



270-RPD814P95

- Sliding toggle on both straps designed to achieve a secure, comfortable fit
- Full face seal with closed-cell foam material provides a secure, comfortable fit



FR OUTER LAYER MATERIAL



270-RPD614P95

- FR outer layer material
- Sliding toggle on both straps designed to achieve a secure, comfortable fit



270-RPD814P950A

- Activated carbon layer to provide relief from nuisance levels of ozone, organic vapors or acid gases below PELs
- Four-point adjustment clips to control the tension of the elastic straps for a precise seal
- Full face seal with closed-cell foam material provides a secure, comfortable fit

Dynamic Standard P95 Disposable Respirators

Versatile NIOSH approved P95 respirator for filtration against oil and non-oil based particulates

- Closed-cell foam seals the respirator for better performance and a secure, comfortable fit
- Unique butterfly exhalation valve controls the flow of air, opening as the user exhales and closing securely as the user inhales
- Durable, clear valve cover protects the butterfly valve and permits quick inspection to ensure the respirator valve is unobstructed and working properly
- Latex-free

STYLE NUMBER	DESCRIPTION	PACK
270-RPD814P95	P95 Disposable Respirator with Butterfly Valve	10 / Box
270-RPD614P95	P95 Disposable Respirator with Butterfly Valve and FR Outer Layer Material	10 / Box
270-RPD814P950A	P95 Disposable Respirator Nuisance Level DV-AG-Ozone with Butterfly Valve	5 / Box



Notched nose bridge provides a secure and comfortable fit



Scan it

Fit Test Kit and Disposable Face Masks

FIT TEST KIT



Bitter Fit Test Kit 270-RPFITBITREX

STYLE NUMBER	DESCRIPTION
270-RPFITBITREX	Bitter fit test kit complete with: Nebulizers, Test and sensitivity solutions, Hood
270-RPBTXSEN	Replacement Fit Test Kit Sensitivity Solution, 6 tube/box
270-RPBTXSOL	Replacement Fit Test Kit Test Solution, 6 tube/box
270-RPHOOD	Replacement Fit Test Hood, 1
270-PRNEBUL	Replacement Fit Kit Nebulizers, 1



Comfort Mask 270-RP1000

Nuisance level mask / Not NIOSH approved

- Provides relief from nuisance levels of dusts
- Not for use where concentrations are at or above the Permissible Exposure Limit (PEL)

STYLE NUMBER	DESCRIPTION	PACK
270-RP1000	Comfort Mask	50 / Box



Disposable Face Mask 270-4000

Nuisance level mask / Not NIOSH approved

- 3-ply pleated construction with 99% Bacterial Filter Efficiency (BFE)
- Latex-free ear loops and adjustable metal nose clip secure the mask over the nose and mouth

STYLE NUMBER	DESCRIPTION	PACK
270-4000	Disposable Face Mask	50 / Box

CHOOSE THE RIGHT RESPIRATOR FOR THE APPLICATION

270-RPD513N95
270-RPD514N95
270-RPD713N95
270-RPD714N95
270-RPD714N95OAO
270-RPD723N95
270-RPD724N95
270-RPD725N95
270-RPD614P95
270-RPD814P95
270-RPD814P95 OAO
270-RPD914P100

APPLICATION & INDUSTRIES	POTENTIAL HAZARDS	FILTER OPTIONS	270-RPD513N95	270-RPD514N95	270-RPD713N95	270-RPD714N95	270-RPD714N95OAO	270-RPD723N95	270-RPD724N95	270-RPD725N95	270-RPD614P95	270-RPD814P95	270-RPD814P95 OAO	270-RPD914P100
Spray Painting, Varnishing, Coating	Solvent-based, Water-based latex	OV/P95												●
Sanding and Grinding	Particulate	N95	●	●	●	●		●	●	●				
Welding	Weld fume	N95					●				●			
	Stainless steel & Galvanized	OV/N95-P100					●						●	
Abatement	Lead	P100												●
	Mold	OV/N95-P100												●
Cement Work	Silica/Dust	N95												●
Cleaning and Janitorial	Bleach	AG/P95												●
	Ammonia*	AM/MA/P95												●
	General Cleaning Products	OV/P95												●
Agriculture	Pesticides & Insecticides	OV/AG/P95-P100											●	●
Construction	Particulate	N95	●	●	●	●		●	●	●				
Manufacturing	Solvents*	OV/N95					●							●
	Particulate	N95	●	●	●	●		●	●	●				
Pharmaceutical Manufacturing	Particulate	N95/P100	●	●	●	●		●	●	●	●	●		●
Chemical Manufacturing	Chlorine*	AM/MA/P95											●	

*Only for use under permitted exposure limit (PEL)

OV = Organic Vapor

AG = Acid Gas

AM = Ammonia

MA = Methylamine



Scan it



Face Covers

HELPS REDUCE THE SPREAD OF DROPLETS AND HARMFUL PARTICLES



POLYESTER FACE COVER



393-FC10

- Reusable 2-Ply 100% polyester Face Cover is soft, comfortable and won't irritate the skin
- Designed with convenient adjustable head straps to ensure the user can achieve a secure comfortable fit
- Shaped to follow the natural contours of the user's face for a superior seal at the nose bridge and reduced eyewear fogging
- Anti-microbial fabric treatment is machine washable for up to 30 wash cycles



ADJUSTABLE HEAD STRAPS

Made of non-irritating material for all-day comfort



CONTOURED SHAPE

Wide sealing area around the entire mask provides a secure fit

KNIT FACE COVER

Ribbed knit provides added warmth



230-FPC-AG-5



230-FPC-BK-5



HI-VISIBILITY

230-FPC-HVC-5

- Large, easy-access filter pocket accepts reusable or disposable media, from a common surgical mask to a paper filter
- Soft against the skin, 100% polyester wicks away moisture and is easy to breathe through even with a filter inserted



COMFORTABLE BY DESIGN

Provides comfortable coverage over the bridge of the nose and mouth



FUNCTIONAL FILTRATION POCKET

Double layered with a functional filtration pocket opening that keeps portable filters in place

Filter not included with Face Cover



ENCASED ELASTIC HEM

The encased elastic in the hem holds the cover up over the nose - no irritating loops or ties

STYLE NUMBER	MATERIAL	CONSTRUCTION	COLOR	SIZE	CASE PACK
230-FPC-AG-5	100% Polyester	2-Ply 2X1 Ribbed Knit	Army Green	One Size-5.5" High	50
230-FPC-BK-5	100% Polyester	2-Ply 2X1 Ribbed Knit	Black	One Size-5.5" High	50
230-FPC-HVC-5	100% Polyester	2-Ply 2X1 Ribbed Knit	High-Vis Yellow	One Size-5.5" High	50
393-FC10	100% Polyester	2-Ply Knit	Steel Gray	One Size Fits Most	300

Designed for general use, not intended to replace N95 or other NIOSH approved respirator mask



Clima-Band™

PROTECTION IN ANY CLIMATE



Scan it

- > Seamless stretch construction
- > Quick dry, sweat absorbing fabric
- > Anti-odor technology
- > Resists UV rays from the sun
- > Blocks wind, sun & dust



RESISTS
SUN



RESISTS
WIND



RESISTS
DUST



VERSATILE: WEAR IT MULTIPLE WAYS



NECKERCHIEF



HEADBAND



CAP



DO RAG



SCARF



BALACLAVA



HAIRBAND



WRISTBAND

PROTECTION IN ANY CLIMATE

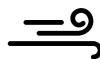

STYLE	COOLING TYPE	OUTER FABRIC	COLOR	SIZE
393-200-CWB	Absorptive Cooling	Nylon / Polyester	Cowboy Blue	10" x 20"
393-200-YEL	Absorptive Cooling	Nylon / Polyester	Hi-Vis Yellow	10" x 20"
395-250FR-B	Absorptive Cooling	Meta-Aramid/Lenzing FR	Black	10" x 20"

SECTION:

Eye and Face Protection



bouton
OPTICAL

ADVANCED LENS TECHNOLOGIES
IN SAFETY EYEWEAR™

This section contains important PPE related to eye and face protection. These products are designed to help shield your eyes and face from impact, debris, dust, splashes and other potential hazards that could present severe injury to the eyes and face. PIP's Bouton® Optical provides a comprehensive line of solutions for safety eyewear needs.

STANDARDS

ANSI/ISEA Z87.1 AND CSA Z94.3

- > Prescribes the design, performance specifications and marking of eye and face safety products
- > Testing Includes:
 - Basic and high impact for lenses and frames
 - UV light transmittance
 - Resistance to flammables and corrosion
 - Optical quality

PRODUCTS

Full Rim – Popular styling for outdoor construction work

Semi-Rimless – Wraparound styling with improved peripheral vision and all-day comfort

Rimless – Lightweight designs with unobstructed peripheral vision and ergonomic fit

Foam Lined – Sealed to keep out dust and airborne particles

Over-the-Glass – Designed to fit over prescription eyewear

Goggles – Help provide protection from projectiles, impact and liquid splash



IMPACT



DUST



CHEMICAL SPLASH



UV LIGHT AND BRIGHT GLARE



HEAT AND SPARKS



PARTICULATES



bouton® LENS TECHNOLOGIES

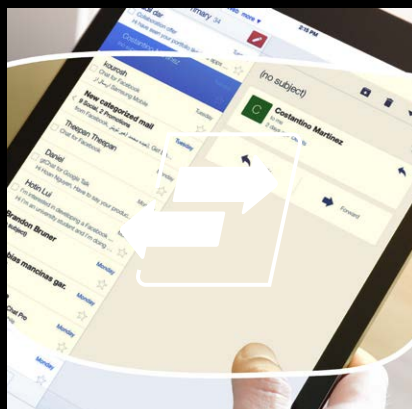

PROTECT AGAINST HARMFUL BLUE LIGHT

Overexposure to blue light, including smart phones, tablets and computer screens, have been known to cause eyestrain, fatigue and possibly contribute to long term macular degeneration. I/O Blue lenses are uniquely coated to help filter out harsh blue light and improve worker comfort and visual acuity. Lenses are treated with a contrast booster to enhance color contrast.



TAKE ANTI-REFLECTIVE PLUS™ TECHNOLOGY OUTDOORS WITH MIRROR PLUS LENSES

A mirror coating on the face of the lens will deflect sunlight from the wearer's eyes, delivering noticeably less glare and reflection than standard gray lenses. Anti-Reflective Plus™ coating on the back of the lens significantly reduces light reflecting back into the eye for enhanced comfort and performance.



THE CLOSEST THING TO NOT WEARING GLASSES

Bouton® Anti-Reflective Plus™ lenses allow an astounding 96% Visible Light Transmission (VLT) compared to the 88-90% VLT provided by standard clear lenses. Durable Anti-Reflective Plus™ coating significantly reduces the amount of light that reflects back into the wearer's eyes providing ultimate visual acuity. Inspect, sort and see with more clarity – and less eye fatigue.

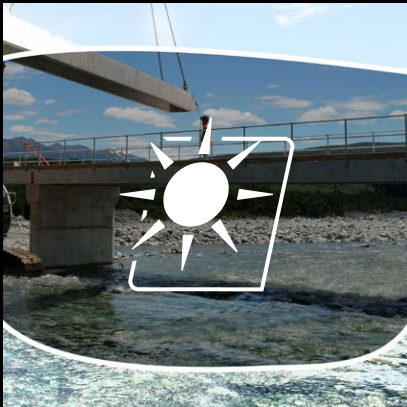

FILTER REFLECTED SUNLIGHT FOR A CLEAR VIEW

Reflected sunlight from smooth surfaces, such as water, pavement and snow can dangerously hinder vision and cause significant eyestrain. Polarized XL5™ lenses filter the scattered light by controlling the angle at which it enters the lens. The result is clearer vision of the surrounding area and greatly reducing eye glare.

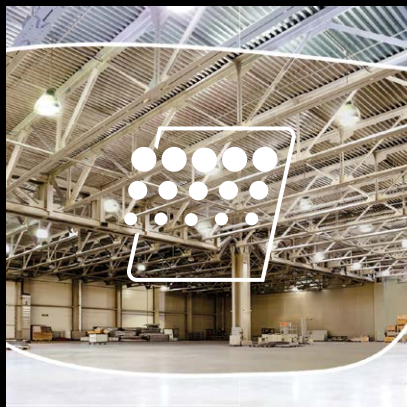

REDUCE GLARE FROM OVERHEAD LIGHT

High-powered overhead lights, such as fluorescent and mercury lighting, can cause glare that increases eye strain. Gradient lenses feature a slight mirror coating on the top portion of the lens, reducing glare, while the remainder of the lens remains clear. As a result, workers are still able to see clearly when looking straight ahead or down at their work.



PROVIDING WORKERS CLEAR VISION IN EXTREME CONDITIONS

Lenses fog for many reasons, all of which are related to ambient temperature and moisture in the air. When a rapid temperature change occurs, micro-water droplets in the air will collect on untreated lenses, causing the lenses to fog and impede vision.

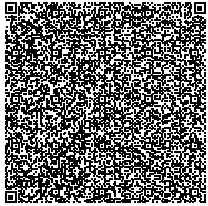

Scan it

SUPERIOR SAFETY AND



Sunburst™ / 250-47

Bayonet temples are rubber co-molded for a secure fit



Squadron™ / 250-53

Nylon bayonet temples eliminate pressure for all-day comfort



Xtricate™ / 250-59

Comfortable design and sporty styling with the ultimate in fog protection



Commander™ / 250-33

Bayonet style temples with non-slip rubber pads for a secure fit



Anser™ / 250-AN

Sleek, sporty style with wraparound lens protection



Fuselage™ / 250-50

Adapts to any working condition with dust goggle conversion



ENHANCED FEATURES



Bond[™] / 250-57

Keyhole bridge design sits naturally on the nose to fit many different faces



Recon[™] / 250-32

Flexible bayonet temples contain rubber pads for a secure, non-slip fit



Captain[™] / 250-46

Bayonet temples with end tips that curve out for ease of placement on face



Radar[™] / 250-45

Bayonet temples are rubber co-molded for a comfortable fit



Fortify[™] / 250-54

Closed-cell foam padding for protection and extended use



Cerifo[™] / 250-CE

Foam padded design converts to a dust goggle



SUNBURST™

250-47

- :: Lightweight, full frame design offers all-day comfort
- :: Bayonet temples are rubber co-molded for a secure fit

LENS TECHNOLOGY:



Sunburst™

STANDARDS MET

STYLE	LENS	COATING	FRAME	ANSI Z87.1+	CSA Z94.3	BASE CURVE	FIT	BRIDGE	TEMPLE	PROP 65
250-47-0041	Gray Polarized XL5™ Technology	Anti-Scratch / Anti-Fog	Black	•		8	Universal	Rubber	Bayonet, Co-Molded	▲ ^R
250-47-0004	Red Mirror Plus™ Technology	Anti-Scratch	Black	•		8	Universal	Rubber	Bayonet, Co-Molded	▲ ^R
250-47-0005	Silver Mirror Plus™ Technology	Anti-Scratch	Black	•		8	Universal	Rubber	Bayonet, Co-Molded	▲ ^R
250-47-0006	Blue Mirror Plus™ Technology	Anti-Scratch	Black	•		8	Universal	Rubber	Bayonet, Co-Molded	▲ ^R
250-47-0007	Gold Mirror Plus™ Technology	Anti-Scratch	Black	•		8	Universal	Rubber	Bayonet, Co-Molded	▲ ^R
250-47-0020	Clear	Anti-Scratch / Anti-Fog	Black	•		8	Universal	Rubber	Bayonet, Co-Molded	▲ ^R
250-47-0021	Gray	Anti-Scratch / Anti-Fog	Black	•		8	Universal	Rubber	Bayonet, Co-Molded	▲ ^R
250-47-1008	Green Mirror Plus™ Technology	Anti-Scratch / Anti-Fog	Brown	•		8	Universal	Rubber	Bayonet, Co-Molded	▲ ^R
250-47-1042	Brown Polarized XL5™ Technology	Anti-Scratch / Anti-Fog	Brown	•		8	Universal	Rubber	Bayonet, Co-Molded	▲ ^R
Squadron™										
250-53-0006	Blue Mirror Plus™ Technology	Anti-Scratch	Black	•		85	Round Head	Molded	Bayonet	▲ ^R
250-53-0020	Clear	Anti-Scratch / Anti-Fog	Black	•		85	Round Head	Molded	Bayonet	▲ ^R
250-53-0021	Gray	Anti-Scratch / Anti-Fog	Black	•		85	Round Head	Molded	Bayonet	▲ ^R
250-53-0022	I/O	Anti-Scratch / Anti-Fog	Black	•		85	Round Head	Molded	Bayonet	▲ ^R
250-53-1024	Brown	Anti-Scratch / Anti-Fog	Camo	•		85	Round Head	Molded	Bayonet	▲ ^R

C = ▲ **WARNING:** Cancer - www.P65Warnings.ca.gov R = ▲ **WARNING:** Reproductive Harm - www.P65Warnings.ca.gov CR = ▲ **WARNING:** Cancer and Reproductive Harm - www.P65Warnings.ca.gov



SQUADRON™

250-53

- ∴ Full frame style designed to provide a universally comfortable fit
- ∴ Nylon bayonet temples eliminate pressure for all-day comfort

LENS TECHNOLOGY:



BOND™

250-57

- ∴ Lightweight nylon frame provides ultimate comfort with practically no pressure behind the ear
- ∴ Keyhole bridge design sits naturally on the nose to fit many different faces

LENS TECHNOLOGY:



RECON™

250-32

- ∴ Lightweight, rimless design for ergonomic fit
- ∴ Flexible bayonet temples contain rubber pads for a secure, non-slip fit

LENS TECHNOLOGY:



Bond™

STANDARDS MET

STYLE	LENS	COATING	FRAME	ANSI Z87.1+	CSA Z94.3	BASE CURVE	FIT	BRIDGE	TEMPLE	PROPS
250-57-0004	Red Mirror Plus™ Technology	Anti-Scratch / Anti-Reflective	Dark Gray	•	•	85	Universal	Keyhole	Spatula	▲ R
250-57-0008	Green Mirror Plus™ Technology	Anti-Scratch / Anti-Reflective	Dark Gray	•	•	85	Universal	Keyhole	Spatula	▲ R
250-57-0020	Clear	Anti-Scratch / Anti-Fog	Dark Gray	•	•	85	Universal	Keyhole	Spatula	▲ R
250-57-0021	Gray	Anti-Scratch / Anti-Fog	Dark Gray	•	•	85	Universal	Keyhole	Spatula	▲ R
250-57-0226	I/O Blue	Anti-Scratch / Anti-Fog	Dark Gray	•	•	85	Universal	Keyhole	Spatula	▲ R
Recon™										
250-32-0010	Clear Anti-Reflective PLUS™	Anti-Scratch / Anti-Reflective	Clear	•	•	9	Universal	Rubber	Bayonet, Rubber Tips	▲ C&R
250-32-0020	Clear	Anti-Scratch / Anti-Fog	Clear	•	•	9	Universal	Rubber	Bayonet, Rubber Tips	▲ C&R
250-32-0021	Gray	Anti-Scratch / Anti-Fog	Black	•	•	9	Universal	Rubber	Bayonet, Rubber Tips	▲ C&R
250-32-0031	Gradient	Anti-Scratch / Anti-Fog	Black	•	•	9	Universal	Rubber	Bayonet, Rubber Tips	▲ C&R
250-32-0226	I/O Blue	Anti-Scratch / Anti-Fog	Brown	•	•	9	Universal	Rubber	Bayonet, Rubber Tips	▲ C&R
250-32-0520	Clear	Anti-Scratch / FogLess 3Sixty™	Clear	•	•	9	Universal	Rubber	Bayonet, Rubber Tips	▲ C&R
250-32-0521	Gray	Anti-Scratch / FogLess 3Sixty™	Black	•	•	9	Universal	Rubber	Bayonet, Rubber Tips	▲ C&R
250-32-0551	Light Gray	FogLess 3Sixty™	Black	•	•	9	Universal	Rubber	Bayonet, Rubber Tips	▲ C&R

C = ▲ WARNING: Cancer - www.P65Warnings.ca.gov

R = ▲ WARNING: Reproductive Harm - www.P65Warnings.ca.gov

C&R = ▲ WARNING: Cancer and Reproductive Harm - www.P65Warnings.ca.gov





COMMANDER™

250-33

- Lightweight, semi-rimless design offers extended eye coverage and all-day comfort
- Bayonet style temples with non-slip rubber pads for a secure fit

LENS TECHNOLOGY:



CAPTAIN™

250-46

- Lightweight, rimless design provides all-day user comfort
- Bayonet temples with end tips that curve out for ease of placement on face

LENS TECHNOLOGY:



RADAR™

250-45

- Lightweight, rimless design offers optimal protection
- Bayonet temples are rubber co-molded for a comfortable fit

LENS TECHNOLOGY:



Commander™

STANDARDS MET

STYLE	LENS	COATING	FRAME	ANSI Z87.1+	CSA Z94.3	BASE CURVE	FIT	BRIDGE	TEMPLE	PROP 65
250-33-0010	Clear Anti-Reflective PLUS™	Anti-Scratch / Anti-Reflective	Black	•	•	9.5	Universal	Rubber	Bayonet, Rubber Tips	▲ ^R
250-33-0020	Clear	Anti-Scratch / Anti-Fog	Black	•	•	9.5	Universal	Rubber	Bayonet, Rubber Tips	▲ ^R
250-33-0021	Gray	Anti-Scratch / Anti-Fog	Black	•	•	9.5	Universal	Rubber	Bayonet, Rubber Tips	▲ ^R
250-33-0041	Gray PolarizedXL5™	Anti-Scratch	Black	•	•	9.5	Universal	Rubber	Bayonet, Rubber Tips	▲ ^R
250-33-0226	I/O Blue	Anti-Scratch / Anti-Fog	Black	•	•	9.5	Universal	Rubber	Bayonet, Rubber Tips	▲ ^R
250-33-1010	Clear Anti-Reflective PLUS™	Anti-Scratch / Anti-Reflective	Bronze	•	•	9.5	Universal	Rubber	Bayonet, Rubber Tips	▲ ^R
250-33-1020	Clear	Anti-Scratch / Anti-Fog	Bronze	•	•	9.5	Universal	Rubber	Bayonet, Rubber Tips	▲ ^R
250-33-1024	Gray	Anti-Scratch / Anti-Fog	Bronze	•	•	9.5	Universal	Rubber	Bayonet, Rubber Tips	▲ ^R
250-33-1042	Brown PolarizedXL5™	Anti-Scratch	Bronze	•	•	9.5	Universal	Rubber	Bayonet, Rubber Tips	▲ ^R
250-33-1226	I/O Blue	Anti-Scratch / Anti-Fog	Bronze	•	•	9.5	Universal	Rubber	Bayonet, Rubber Tips	▲ ^R
Radar™										
250-45-0010	Clear Anti-Reflective PLUS™	Anti-Scratch / Anti-Reflective	Gray	•	•	9	Universal	Rubber	Bayonet, Co-Molded	▲ ^R
250-45-0020	Clear	Anti-Scratch / Anti-Fog	Gray	•	•	9	Universal	Rubber	Bayonet, Co-Molded	▲ ^R
250-45-0021	Gray	Anti-Scratch / Anti-Fog	Gray	•	•	9	Universal	Rubber	Bayonet, Co-Molded	▲ ^R
250-45-0226	I/O Blue	Anti-Scratch / Anti-Fog	Gray	•	•	9	Universal	Rubber	Bayonet, Co-Molded	▲ ^R
250-45-1010	Clear Anti-Reflective PLUS™	Anti-Scratch / Anti-Reflective	Red	•	•	9	Universal	Rubber	Bayonet, Co-Molded	▲ ^R
250-45-1020	Clear	Anti-Scratch / Anti-Fog	Red	•	•	9	Universal	Rubber	Bayonet, Co-Molded	▲ ^R
250-45-1021	Gray	Anti-Scratch / Anti-Fog	Red	•	•	9	Universal	Rubber	Bayonet, Co-Molded	▲ ^R
250-45-1226	I/O Blue	Anti-Scratch / Anti-Fog	Red	•	•	9	Universal	Rubber	Bayonet, Co-Molded	▲ ^R
Captain™										
250-46-0010	Clear Anti-Reflective PLUS™	Anti-Scratch / Anti-Reflective	Clear	•	•	9	Narrow	Rubber	Bayonet, Rubber Tips	▲ ^R
250-46-0020	Clear	Anti-Scratch / Anti-Fog	Clear	•	•	9	Narrow	Rubber	Bayonet, Rubber Tips	▲ ^R
250-46-0021	Gray	Anti-Scratch / Anti-Fog	Gray	•	•	9	Narrow	Rubber	Bayonet, Rubber Tips	▲ ^R
250-46-0226	I/O Blue	Anti-Scratch / Anti-Fog	Brown	•	•	9	Narrow	Rubber	Bayonet, Rubber Tips	▲ ^R
250-46-0520	Clear	Anti-Scratch / FogLess® 3Sixty™	Clear	•	•	9	Narrow	Rubber	Bayonet, Rubber Tips	▲ ^R
250-46-0521	Gray	Anti-Scratch / FogLess® 3Sixty™	Gray	•	•	9	Narrow	Rubber	Bayonet, Rubber Tips	▲ ^R

C = ▲ WARNING: Cancer - www.P65Warnings.ca.gov R = ▲ WARNING: Reproductive Harm - www.P65Warnings.ca.gov C&R = ▲ WARNING: Cancer and Reproductive Harm - www.P65Warnings.ca.gov



ANSER™

250-AN

- Lightweight, semi-rimless design provides all-day user comfort
- Sleek, sporty style with wraparound lens protection

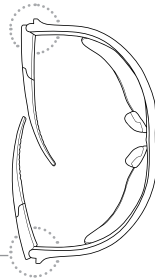

UNIQUE FOLDING TEMPLES



Anser™

STANDARDS MET

STYLE	LENS	COATING	FRAME	DIOPTER	ANSI Z87.1+	CSA Z94.3	BASE CURVE	FIT	BRIDGE	TEMPLE	PROP 65
250-AN-10110	Clear	Anti-Scratch	Black	-	•		9	Universal	Rubber	Bayonet, Rubber Tips	▲ R
250-AN-10111	Clear	Anti-Scratch, Anti-Fog	Black	-	•		9	Universal	Rubber	Bayonet, Rubber Tips	▲ R
250-AN-10112	Gray	Anti-Scratch	Black	-	•		9	Universal	Rubber	Bayonet, Rubber Tips	▲ R
250-AN-10113	Light Blue	Anti-Scratch	Black	-	•		9	Universal	Rubber	Bayonet, Rubber Tips	▲ R
250-AN-10114	I/O	Anti-Scratch	Black	-	•		9	Universal	Rubber	Bayonet, Rubber Tips	▲ R
250-AN-10115	Blue Mirror	Anti-Scratch	Black	-	•		9	Universal	Rubber	Bayonet, Rubber Tips	▲ R
250-AN-10116	Red Mirror	Anti-Scratch	Black	-	•		9	Universal	Rubber	Bayonet, Rubber Tips	▲ R
250-AN-10117	Gray	Anti-Scratch	Red	-	•		9	Universal	Rubber	Bayonet, Rubber Tips	▲ R
250-AN-10118	IR Filter 3.0	Anti-Scratch	Black	-	•		9	Universal	Rubber	Bayonet, Rubber Tips	▲ R
250-AN-10119	IR Filter 5.0	Anti-Scratch	Black	-	•		9	Universal	Rubber	Bayonet, Rubber Tips	▲ R
250-AN-10120	Amber	Anti-Scratch	Black	-	•		9	Universal	Rubber	Bayonet, Rubber Tips	▲ R
250-AN-10121	Brown	Anti-Scratch	Camouflage	-	•		9	Universal	Rubber	Bayonet, Rubber Tips	▲ R
250-AN-10122	Amber	Anti-Scratch	Camouflage	-	•		9	Universal	Rubber	Bayonet, Rubber Tips	▲ R
250-AN-10123	Gray	Anti-Scratch	Camouflage	-	•		9	Universal	Rubber	Bayonet, Rubber Tips	▲ R
250-AN-10124	Brown	Anti-Scratch, Anti-Fog	Camouflage	-	•		9	Universal	Rubber	Bayonet, Rubber Tips	▲ R
250-AN-10125	Silver Mirror	Anti-Scratch	Black	-	•		9	Universal	Rubber	Bayonet, Rubber Tips	▲ R
250-AN-10126	Gray	Anti-Scratch, Anti-Fog	Black	-	•		9	Universal	Rubber	Bayonet, Rubber Tips	▲ R
250-AN-10127	Amber	Anti-Scratch, Anti-Fog	Camouflage	-	•		9	Universal	Rubber	Bayonet, Rubber Tips	▲ R
250-AN-10128	Silver Mirror	Anti-Scratch	Camouflage	-	•		9	Universal	Rubber	Bayonet, Rubber Tips	▲ R
250-AN-10130	Clear	Anti-Scratch	Camouflage	-	•		9	Universal	Rubber	Bayonet, Rubber Tips	▲ R
250-AN-10131	Clear	Anti-Scratch, Anti-Fog	Camouflage	-	•		9	Universal	Rubber	Bayonet, Rubber Tips	▲ R
250-AN-10520	Clear	FogLess 3Sixty	Black	-	•		9	Universal	Rubber	Bayonet, Rubber Tips	▲ R
250-AN-10521	Gray	FogLess 3Sixty	Black	-	•		9	Universal	Rubber	Bayonet, Rubber Tips	▲ R
250-AN-10551	Light Gray	FogLess 3Sixty	Black	-	•		9	Universal	Rubber	Bayonet, Rubber Tips	▲ R
250-AN-11115	Clear	Anti-Scratch, Anti-Fog	Black	+1.50	•		9	Universal	Rubber	Bayonet, Rubber Tips	▲ R
250-AN-11120	Clear	Anti-Scratch, Anti-Fog	Black	+2.00	•		9	Universal	Rubber	Bayonet, Rubber Tips	▲ R
250-AN-11125	Clear	Anti-Scratch, Anti-Fog	Black	+2.50	•		9	Universal	Rubber	Bayonet, Rubber Tips	▲ R

C = ▲ WARNING: Cancer - www.P65Warnings.ca.gov R = ▲ WARNING: Reproductive Harm - www.P65Warnings.ca.gov CR = ▲ WARNING: Cancer and Reproductive Harm - www.P65Warnings.ca.gov



bouton

Foam Lined

PROTECTS AGAINST DEBRIS AND AIRBORNE PARTICLES

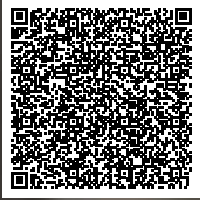

Scan it



MEETS ANSI
Z87.1+

**ZENON Z12™ FOAM
250-01-F**

Popular, lightweight style with foam padding creates a seal to keep out dust and airborne particles



Fuselage™

STANDARDS MET

STYLE	LENS	COATING	FRAME	DIOPTR	ANSI Z87.1+	CSA Z94.3	BASE CURVE	FIT	BRIDGE	TEMPLE	PROP 65
250-50-0420	□ Clear	Anti-Scratch / Anti-Fog	■ Black	-	•		8	Universal	Molded	Bayonet, Rubber Tips	▲ ^R
250-50-0421	■ Gray	Anti-Scratch / Anti-Fog	■ Black	-	•		8	Universal	Molded	Bayonet, Rubber Tips	▲ ^R
250-50-0422	□ I/O	Anti-Scratch / Anti-Fog	■ Black	-	•		8	Universal	Molded	Bayonet, Rubber Tips	▲ ^R
250-50-0425	□ Silver Mirror	Anti-Scratch / Anti-Fog	■ Black	-	•		8	Universal	Molded	Bayonet, Rubber Tips	▲ ^R
250-50-0426	■ Blue Mirror	Anti-Scratch / Anti-Fog	■ Black	-	•		8	Universal	Molded	Bayonet, Rubber Tips	▲ ^R
250-50-0429	■ Amber	Anti-Scratch / Anti-Fog	■ Black	-	•		8	Universal	Molded	Bayonet, Rubber Tips	▲ ^R
250-50-0520	□ Clear	Anti-Scratch, FogLess 3Sixty	■ Black	-	•		8	Universal	Molded	Bayonet, Rubber Tips	▲ ^R
250-50-0521	■ Gray	Anti-Scratch, FogLess 3Sixty	■ Black	-	•		8	Universal	Molded	Bayonet, Rubber Tips	▲ ^R
Fuselage™ Reader											
250-51-0015	□ Clear	Anti-Scratch / Anti-Fog	■ Black	+1.50	•		8	Universal	Molded	Bayonet, Rubber Tips	▲ ^R
250-51-0020	□ Clear	Anti-Scratch / Anti-Fog	■ Black	+2.00	•		8	Universal	Molded	Bayonet, Rubber Tips	▲ ^R
250-51-0025	□ Clear	Anti-Scratch / Anti-Fog	■ Black	+2.50	•		8	Universal	Molded	Bayonet, Rubber Tips	▲ ^R
250-51-0030	□ Clear	Anti-Scratch / Anti-Fog	■ Black	+3.00	•		8	Universal	Molded	Bayonet, Rubber Tips	▲ ^R
Cefiro™											
250-CE-10090	□ Clear	Anti-Scratch / Anti-Fog	■ Black	-	•		8.75	Narrow	Rubber	Bayonet	▲ ^R
250-CE-10091	■ Gray	Anti-Scratch / Anti-Fog	■ Black	-	•		8.75	Narrow	Rubber	Bayonet	▲ ^R
250-CE-10092	□ I/O	Anti-Scratch / Anti-Fog	■ Black	-	•		8.75	Narrow	Rubber	Bayonet	▲ ^R
250-CE-10093	■ Blue Mirror	Anti-Scratch / Anti-Fog	■ Black	-	•		8.75	Narrow	Rubber	Bayonet	▲ ^R
250-CE-10095	□ Silver Mirror	Anti-Scratch / Anti-Fog	■ Black	-	•		8.75	Narrow	Rubber	Bayonet	▲ ^R
Fortify™											
250-54-0020	□ Clear	Anti-Scratch / Anti-Fog	■ Gray	-	•		9	Universal	Molded	Rubber Tips	▲ ^R
250-54-0021	■ Gray	Anti-Scratch / Anti-Fog	■ Gray	-	•		9	Universal	Molded	Rubber Tips	▲ ^R
250-54-0024	■ IR Filter	Anti-Fog	■ Green	-	•		9	Universal	Molded	Rubber Tips	▲ ^R
250-54-0520	□ Clear	Anti-Scratch / FogLess 3Sixty™	■ Gray	-	•		9	Universal	Molded	Rubber Tips	▲ ^R
250-54-0551	□ Light Gray	FogLess 3Sixty™	■ Gray	-	•		9	Universal	Molded	Rubber Tips	▲ ^R
Zenon Z12™ Foam											
250-01-F020	□ Clear	Anti-Scratch / Anti-Fog	■ Black	-	•		9.5	Universal	Molded	Spatula	▲ ^R
250-01-F021	■ Gray	Anti-Scratch / Anti-Fog	■ Black	-	•		9.5	Universal	Molded	Spatula	▲ ^R
250-01-F022	□ I/O	Anti-Scratch / Anti-Fog	■ Black	-	•		9.5	Universal	Molded	Spatula	▲ ^R

⚠️ **WARNING:** Cancer - www.P65Warnings.ca.gov ⚠️ **WARNING:** Reproductive Harm - www.P65Warnings.ca.gov ⚠️ **WARNING:** Cancer and Reproductive Harm - www.P65Warnings.ca.gov



CEFIRO™
250-CE

Foam padded design converts to a dust goggle

HYBRID
MEETS ANSI
Z87.1+



FORTIFY™
250-54

Closed-cell foam padding for protection and extended use

HYBRID
MEETS ANSI
Z87.1+



FUSELAGE™
250-50

Adapts to any working condition with dust goggle conversion

HYBRID
MEETS ANSI
Z87.1+

DUST GOGGLE STRAPS INCLUDED





TRADITIONAL SPECTACLE
249-5907

Classic styling in a durable propionate frame

MEETS ANSI
Z87.1+

Full Frame

WITH SIDE SHIELD PROTECTION

Traditional Spectacle		STANDARDS MET								
STYLE	LENS	COATING	FRAME	ANSI Z87.1+	CSA Z94.3	BASE CURVE	FIT	BRIDGE	TEMPLE	PROP 65
249-5907-207	IR Filter 3.0	Anti-Scratch / Anti-Fog	Smoke	•		6	Universal	Molded	Spatula	⚠️ R
249-5907-400	Clear	Anti-Scratch / Anti-Fog	Smoke	•		6	Universal	Molded	Spatula	⚠️ R
249-5907-401	Gray	Anti-Scratch / Anti-Fog	Smoke	•		6	Universal	Molded	Spatula	⚠️ R

C=⚠️ WARNING: Cancer - www.P65Warnings.ca.gov
 R=⚠️ WARNING: Reproductive Harm - www.P65Warnings.ca.gov
 CR=⚠️ WARNING: Cancer and Reproductive Harm - www.P65Warnings.ca.gov

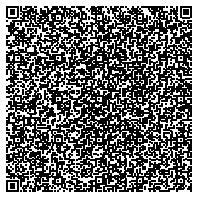

Scan it

Rimless

UNOBSTRUCTED PERIPHERAL VISION



ZENON Z12™
250-01

MEETS ANSI Z87.1+ MEETS CSA Z94.3

Popular style fits most workers and applications



ZENON Z11SM™
250-00

MEETS ANSI Z87.1+

Redesigned Z12™ for narrower faces

NARROW FIT



ZENON Z12R™
250-27

MEETS ANSI Z87.1+

Reader version of the popular Z12™ style in +0.25 diopters

READING MAGNIFIER

Zenon Z12™

STANDARDS MET

STYLE	LENS	COATING	FRAME	DIOPTR	ANSI Z87.1+	CSA Z94.3	BASE CURVE	FIT	BRIDGE	TEMPLE	PROP 65
250-01-0000	Clear	Anti-Scratch	Black	-	•		95	Universal	Molded	Spatula	⚠ ^R
250-01-0001	Gray	Anti-Scratch	Black	-	•		95	Universal	Molded	Spatula	⚠ ^R
250-01-0002	I/O	Anti-Scratch	Black	-	•		95	Universal	Molded	Spatula	⚠ ^R
250-01-0004	Orange	Anti-Scratch	Black	-	•		95	Universal	Molded	Spatula	⚠ ^R
250-01-0005	Silver Mirror	Anti-Scratch	Black	-	•		95	Universal	Molded	Spatula	⚠ ^R
250-01-0020	Clear	Anti-Scratch / Anti-Fog	Black	-	•		95	Universal	Molded	Spatula	⚠ ^R
250-01-0021	Gray	Anti-Scratch / Anti-Fog	Black	-	•	•	95	Universal	Molded	Spatula	⚠ ^R
250-01-0080	Clear	Uncoated	Black	-	•		95	Universal	Molded	Spatula	⚠ ^R
250-01-0300	Clear	Anti-Scratch	Clear	-	•		95	Universal	Molded	Spatula	⚠ ^R
250-01-0320	Clear	Anti-Scratch	Clear	-	•		95	Universal	Molded	Spatula	⚠ ^R
250-01-0900	Clear	Anti-Scratch	Clear	-	•	•	95	Universal	Molded	Spatula	⚠ ^R
250-01-0902	I/O	Anti-Scratch	Clear	-	•		95	Universal	Molded	Spatula	⚠ ^R
250-01-0920	Clear	Anti-Scratch / Anti-Fog	Clear	-	•	•	95	Universal	Molded	Spatula	⚠ ^R
250-01-0980	Clear	Uncoated	Clear	-	•		95	Universal	Molded	Spatula	⚠ ^R
250-01-5503	Light Blue	Anti-Scratch	Light Blue	-	•		95	Universal	Molded	Spatula	⚠ ^R
250-01-5504	Dark Brown	Anti-Scratch	Dark Brown	-	•		95	Universal	Molded	Spatula	⚠ ^R
250-01-5509	Amber	Anti-Scratch	Amber	-	•		95	Universal	Molded	Spatula	⚠ ^R
250-01-F020	Clear	Anti-Scratch / Anti-Fog	Black	-	•		95	Universal	Molded	Spatula	⚠ ^R
250-01-F021	Gray	Anti-Scratch / Anti-Fog	Black	-	•		95	Universal	Molded	Spatula	⚠ ^R
250-01-F022	I/O	Anti-Scratch / Anti-Fog	Black	-	•		95	Universal	Molded	Spatula	⚠ ^R

Zenon Z11SM™

250-00-0000	Clear	Anti-Scratch	Black	-	•		10	Narrow	Molded	Spatula	⚠ ^R
250-00-0001	Gray	Anti-Scratch / Anti-Fog	Black	-	•		10	Narrow	Molded	Spatula	⚠ ^R
250-00-0002	I/O	Anti-Scratch	Black	-	•		10	Narrow	Molded	Spatula	⚠ ^R
250-00-0020	Clear	Anti-Scratch / Anti-Fog	Clear	-	•		10	Narrow	Molded	Spatula	⚠ ^R
250-00-0900	Clear	Anti-Scratch	Clear	-	•		10	Narrow	Molded	Spatula	⚠ ^R
250-00-0920	Clear	Anti-Scratch / Anti-Fog	Black	-	•		10	Narrow	Molded	Spatula	⚠ ^R

Zenon Z12R™ Readers

250-27-0010	Clear	Anti-Scratch	Clear	+1.00	•		925	Universal	Rubber	Spatula, Co-Molded	⚠ ^R
250-27-0012	Clear	Anti-Scratch	Clear	+1.25	•		925	Universal	Rubber	Spatula, Co-Molded	⚠ ^R
250-27-0015	Clear	Anti-Scratch	Clear	+1.50	•		925	Universal	Rubber	Spatula, Co-Molded	⚠ ^R
250-27-0017	Clear	Anti-Scratch	Clear	+1.75	•		925	Universal	Rubber	Spatula, Co-Molded	⚠ ^R
250-27-0020	Clear	Anti-Scratch	Clear	+2.00	•		925	Universal	Rubber	Spatula, Co-Molded	⚠ ^R
250-27-0022	Clear	Anti-Scratch	Clear	+2.25	•		925	Universal	Rubber	Spatula, Co-Molded	⚠ ^R
250-27-0025	Clear	Anti-Scratch	Clear	+2.50	•		925	Universal	Rubber	Spatula, Co-Molded	⚠ ^R
250-27-0027	Clear	Anti-Scratch	Clear	+2.75	•		925	Universal	Rubber	Spatula, Co-Molded	⚠ ^R
250-27-0030	Clear	Anti-Scratch	Clear	+3.00	•		925	Universal	Rubber	Spatula, Co-Molded	⚠ ^R
250-27-0115	Gray	Anti-Scratch	Gray	+1.50	•		925	Universal	Rubber	Spatula, Co-Molded	⚠ ^R
250-27-0120	Gray	Anti-Scratch	Gray	+2.00	•		925	Universal	Rubber	Spatula, Co-Molded	⚠ ^R
250-27-0125	Gray	Anti-Scratch	Gray	+2.50	•		925	Universal	Rubber	Spatula, Co-Molded	⚠ ^R
250-27-0130	Gray	Anti-Scratch	Gray	+3.00	•		925	Universal	Rubber	Spatula, Co-Molded	⚠ ^R

C=⚠^R WARNING: Cancer - www.P65Warnings.ca.gov R=⚠^R WARNING: Reproductive Harm - www.P65Warnings.ca.gov C&R=⚠^R WARNING: Cancer and Reproductive Harm - www.P65Warnings.ca.gov



ZENON Z13™
250-06

Flexible rubber temples

RUBBER
TEMPLE TIPS

MEETS ANSI
Z87.1+

MEETS CSA
Z94.3

ZENON Z14SN™
250-08

Flexible rubber temples and comfortable rubber nose bridge

RUBBER
NOSE BRIDGE

MEETS ANSI
Z87.1+

MEETS CSA
Z94.3

ZENON Z13R™
250-26

Reader version of the popular Z13™ style in +0.25 diopters

READING
MAGNIFIER

MEETS ANSI
Z87.1+

Zenon Z13™

STANDARDS MET

STYLE	LENS	COATING	FRAME	DIOPTR	ANSI Z87.1+	CSA Z94.3	BASE CURVE	FIT	BRIDGE	TEMPLE	PROP 65
250-06-0000	□ Clear	Anti-Scratch	□ Clear	-	•		10	Universal	Molded	Rubber Tips	⚠ ^R
250-06-0002	□ I/O	Anti-Scratch	□ Clear	-	•	•	10	Universal	Molded	Rubber Tips	⚠ ^R
250-06-0005	□ Silver Mirror	Anti-Scratch	■ Black	-	•		10	Universal	Molded	Rubber Tips	⚠ ^R
250-06-0006	■ Blue Mirror	Anti-Scratch	■ Black	-	•		10	Universal	Molded	Rubber Tips	⚠ ^R
250-06-0014	■ IR Filter 1.7	Uncoated	■ Smoke	-	•		10	Universal	Molded	Rubber Tips	⚠ ^R
250-06-0020	□ Clear	Anti-Scratch / Anti-Fog	□ Clear	-	•	•	10	Universal	Molded	Rubber Tips	⚠ ^R
250-06-0080	□ Clear	Uncoated	□ Clear	-	•		10	Universal	Molded	Rubber Tips	⚠ ^R
250-06-5501	■ Gray	Anti-Scratch	■ Dark Gray	-	•		10	Universal	Molded	Rubber Tips	⚠ ^R
250-06-5503	■ Light Blue	Anti-Scratch	■ Light Blue	-	•		10	Universal	Molded	Rubber Tips	⚠ ^R
250-06-5504	■ Dark Brown	Anti-Scratch	■ Dark Brown	-	•		10	Universal	Molded	Rubber Tips	⚠ ^R
250-06-5509	■ Amber	Anti-Scratch	■ Amber	-	•		10	Universal	Molded	Rubber Tips	⚠ ^R
250-06-5521	■ Gray	Anti-Scratch / Anti-Fog	■ Dark Gray	-	•	•	10	Universal	Molded	Rubber Tips	⚠ ^R
Zenon Z14SN™											
250-08-0000	□ Clear	Anti-Scratch	□ Clear	-	•		10	Universal	Rubber	Rubber Tips	⚠ ^R
250-08-0001	■ Gray	Anti-Scratch	■ Black	-	•		10	Universal	Rubber	Rubber Tips	⚠ ^R
250-08-0002	□ I/O	Anti-Scratch	□ Clear	-	•		10	Universal	Rubber	Rubber Tips	⚠ ^R
250-08-0005	□ Silver Mirror	Anti-Scratch	■ Black	-	•		10	Universal	Rubber	Rubber Tips	⚠ ^R
250-08-0020	□ Clear	Anti-Scratch / Anti-Fog	□ Clear	-	•	•	10	Universal	Rubber	Rubber Tips	⚠ ^R
250-08-0021	■ Gray	Anti-Scratch / Anti-Fog	■ Black	-	•	•	10	Universal	Rubber	Rubber Tips	⚠ ^R
250-08-5503	■ Light Blue	Anti-Scratch	■ Light Blue	-	•		10	Universal	Rubber	Rubber Tips	⚠ ^R
250-08-5509	■ Amber	Anti-Scratch / Anti-Fog	■ Amber	-	•		10	Universal	Rubber	Rubber Tips	⚠ ^R
Zenon Z13R™ Readers											
250-26-0010	□ Clear	Anti-Scratch	□ Clear	+1.00	•		10	Universal	Molded	Rubber Tips	⚠ ^{C&R}
250-26-0012	□ Clear	Anti-Scratch	□ Clear	+1.25	•		10	Universal	Molded	Rubber Tips	⚠ ^{C&R}
250-26-0015	□ Clear	Anti-Scratch	□ Clear	+1.50	•		10	Universal	Molded	Rubber Tips	⚠ ^{C&R}
250-26-0017	□ Clear	Anti-Scratch	□ Clear	+1.75	•		10	Universal	Molded	Rubber Tips	⚠ ^{C&R}
250-26-0020	□ Clear	Anti-Scratch	□ Clear	+2.00	•		10	Universal	Molded	Rubber Tips	⚠ ^{C&R}
250-26-0022	□ Clear	Anti-Scratch	□ Clear	+2.25	•		10	Universal	Molded	Rubber Tips	⚠ ^{C&R}
250-26-0025	□ Clear	Anti-Scratch	□ Clear	+2.50	•		10	Universal	Molded	Rubber Tips	⚠ ^{C&R}
250-26-0030	□ Clear	Anti-Scratch	□ Clear	+3.00	•		10	Universal	Molded	Rubber Tips	⚠ ^{C&R}

C=⚠^R WARNING: Cancer - www.P65Warnings.ca.gov R=⚠^R WARNING: Reproductive Harm - www.P65Warnings.ca.gov C&R=⚠^{C&R} WARNING: Cancer and Reproductive Harm - www.P65Warnings.ca.gov



bouton

ULTIMATE IN COMFORT AND STYLE



Scan it



ZENON Z-LYTE™
250-09

The lightest eye protection on the market provides unparalleled comfort and styling

MEETS ANSI Z87.1+



ZENON Z-LYTE II™
250-13

New improved squared lens design with a sleek, modern look

MEETS ANSI Z87.1+



PULSE™
250-29

Style and user comfort in a lightweight design

MEETS ANSI Z87.1+

RUBBER NOSE BRIDGE

Zenon Z-Lyte™

STANDARDS MET

STYLE	LENS	COATING	FRAME	ANSI Z87.1+	CSA Z94.3	BASE CURVE	FIT	BRIDGE	TEMPLE	PROP 65
250-09-0000	☐ Clear	Anti-Scratch	☐ Clear	•		10	Universal	Molded	Spatula	⚠ ^R
250-09-0001	■ Gray	Anti-Scratch	■ Gray	•		10	Universal	Molded	Spatula	⚠ ^R
250-09-0002	□ I/O	Anti-Scratch	☐ Clear	•		10	Universal	Molded	Spatula	⚠ ^R
250-09-0020	☐ Clear	Anti-Scratch / Anti-Fog	☐ Clear	•		10	Universal	Molded	Spatula	⚠ ^R
250-09-0021	■ Gray	Anti-Scratch / Anti-Fog	■ Gray	•		10	Universal	Molded	Spatula	⚠ ^R
Zenon Z-Lyte II™										
250-13-0000	☐ Clear	Anti-Scratch	☐ Clear	•		10	Universal	Molded	Spatula	⚠ ^R
250-13-0001	■ Gray	Anti-Scratch	■ Gray	•		10	Universal	Molded	Spatula	⚠ ^R
250-13-0002	□ I/O	Anti-Scratch	☐ Clear	•		10	Universal	Molded	Spatula	⚠ ^R
250-13-0020	☐ Clear	Anti-Scratch / Anti-Fog	☐ Clear	•		10	Universal	Molded	Spatula	⚠ ^R
250-13-0021	■ Gray	Anti-Scratch / Anti-Fog	■ Gray	•		10	Universal	Molded	Spatula	⚠ ^R
Pulse™										
250-49-0000	☐ Clear	Anti-Scratch	☐ Clear	•		9.5	Universal	Rubber	Bayonet, Rubber Tips	⚠ ^R
250-49-0020	☐ Clear	Anti-Scratch / Anti-Fog	☐ Clear	•		9.5	Universal	Rubber	Bayonet, Rubber Tips	⚠ ^R
250-49-0021	■ Gray	Anti-Scratch / Anti-Fog	■ Gray	•		9.5	Universal	Rubber	Bayonet, Rubber Tips	⚠ ^R
250-49-0022	□ I/O	Anti-Scratch / Anti-Fog	☐ Clear	•		9.5	Universal	Rubber	Bayonet, Rubber Tips	⚠ ^R
250-49-0520	☐ Clear	FogLess® 3Sixty™	☐ Clear	•		9.5	Universal	Rubber	Bayonet, Rubber Tips	⚠ ^R
250-49-0521	■ Gray	FogLess® 3Sixty™	■ Gray	•		9.5	Universal	Rubber	Bayonet, Rubber Tips	⚠ ^R

C = ⚠^R WARNING: Cancer - www.P65Warnings.ca.gov R = ⚠^R WARNING: Reproductive Harm - www.P65Warnings.ca.gov CR = ⚠^R WARNING: Cancer and Reproductive Harm - www.P65Warnings.ca.gov

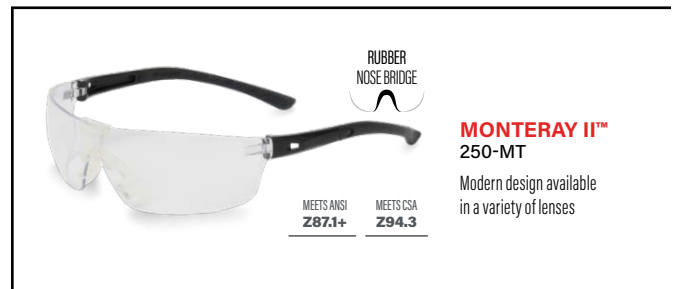

Wilco™

STANDARDS MET

STYLE	LENS	COATING	FRAME	ANSI Z87.1+	CSA Z94.3	BASE CURVE	FIT	BRIDGE	TEMPLE	PROP 65
250-92-0000	□ Clear	Anti-Scratch	■ Black	•		7	Universal	Rubber	Adjustable Spatula	⚠️ R
250-92-0001	■ Gray	Anti-Scratch	■ Black	•		7	Universal	Rubber	Adjustable Spatula	⚠️ R
250-92-0002	□ I/O	Anti-Scratch	■ Black	•		7	Universal	Rubber	Adjustable Spatula	⚠️ R
250-92-0005	□ Mirror	Anti-Scratch	■ Black	•		7	Universal	Rubber	Adjustable Spatula	⚠️ R
250-92-0009	■ Amber	Anti-Scratch	■ Black	•		7	Universal	Rubber	Adjustable Spatula	⚠️ R
250-92-0020	□ Clear	Anti-Scratch / Anti-Fog	■ Black	•		7	Universal	Rubber	Adjustable Spatula	⚠️ R
250-92-0021	■ Gray	Anti-Scratch / Anti-Fog	■ Black	•		7	Universal	Rubber	Adjustable Spatula	⚠️ R
Monteray II™										
250-MT-10070	□ Clear	Anti-Scratch	■ Black	•		9.75	Universal	Rubber	Rubber Tips	⚠️ R
250-MT-10071	□ Clear	Anti-Scratch / Anti-Fog	■ Black	•		9.75	Universal	Rubber	Rubber Tips	⚠️ R
250-MT-10072	■ Gray	Anti-Scratch	■ Black	•		9.75	Universal	Rubber	Rubber Tips	⚠️ R
250-MT-10074	■ Amber	Anti-Scratch	■ Black	•		9.75	Universal	Rubber	Rubber Tips	⚠️ R
250-MT-10075	□ I/O	Anti-Scratch	■ Black	•		9.75	Universal	Rubber	Rubber Tips	⚠️ R

C = ⚠️ WARNING: Cancer - www.P65Warnings.ca.gov

R = ⚠️ WARNING: Reproductive Harm - www.P65Warnings.ca.gov

C&R = ⚠️ WARNING: Cancer and Reproductive Harm - www.P65Warnings.ca.gov



bouton

Women's Rimless

DESIGNED TO FIT WOMEN



Scan it



EVA®
250-10

Safety eyewear designed specifically for women

MEETS ANSI
Z87.1+



EVA® PETITE
250-11

Women's style designed for slender faces

MEETS ANSI
Z87.1+

SLENDER
FIT



LADY EVA®
250-12

Safety readers engineered for women

MEETS ANSI
Z87.1+

READING
MAGNIFIER

Eva®

STANDARDS MET

STYLE	LENS	COATING	FRAME	DIOPTR	ANSI Z87+	CSA Z94.3	BASE CURVE	FIT	BRIDGE	TEMPLE	PROTEG
250-10-0900	<input type="checkbox"/> Clear	Anti-Scratch	<input checked="" type="checkbox"/> Pink	-	•		10	Women	Molded	Rubber Tips	R
250-10-0904	<input checked="" type="checkbox"/> Pink	Anti-Scratch	<input checked="" type="checkbox"/> Pink	-	•		10	Women	Molded	Rubber Tips	R
250-10-0920	<input type="checkbox"/> Clear	Anti-Scratch, Anti-Fog	<input checked="" type="checkbox"/> Pink	-	•		10	Women	Molded	Rubber Tips	R
250-10-5501	<input checked="" type="checkbox"/> Gray	Anti-Scratch	<input checked="" type="checkbox"/> Pink	-	•		10	Women	Molded	Rubber Tips	R
Eva® Petite											
250-11-0900	<input type="checkbox"/> Clear	Anti-Scratch	<input checked="" type="checkbox"/> Pink	-	•		11	Women	Molded	Rubber Tips	R
250-11-0904	<input checked="" type="checkbox"/> Pink	Anti-Scratch	<input checked="" type="checkbox"/> Pink	-	•		11	Women	Molded	Rubber Tips	R
250-11-0920	<input type="checkbox"/> Clear	Anti-Scratch, Anti-Fog	<input checked="" type="checkbox"/> Pink	-	•		11	Women	Molded	Rubber Tips	R
250-11-5501	<input checked="" type="checkbox"/> Gray	Anti-Scratch	<input checked="" type="checkbox"/> Pink	-	•		11	Women	Molded	Rubber Tips	R
Lady Eva® Reader											
250-12-0100	<input type="checkbox"/> Clear	Anti-Scratch	<input checked="" type="checkbox"/> Pink	+1.00	•		10	Women	Molded	Rubber Tips	R
250-12-0125	<input type="checkbox"/> Clear	Anti-Scratch	<input checked="" type="checkbox"/> Pink	+1.25	•		10	Women	Molded	Rubber Tips	R
250-12-0150	<input type="checkbox"/> Clear	Anti-Scratch	<input checked="" type="checkbox"/> Pink	+1.50	•		10	Women	Molded	Rubber Tips	R
250-12-0175	<input type="checkbox"/> Clear	Anti-Scratch	<input checked="" type="checkbox"/> Pink	+1.75	•		10	Women	Molded	Rubber Tips	R
250-12-0200	<input type="checkbox"/> Clear	Anti-Scratch	<input checked="" type="checkbox"/> Pink	+2.00	•		10	Women	Molded	Rubber Tips	R
250-12-0225	<input type="checkbox"/> Clear	Anti-Scratch	<input checked="" type="checkbox"/> Pink	+2.25	•		10	Women	Molded	Rubber Tips	R
250-12-0250	<input type="checkbox"/> Clear	Anti-Scratch	<input checked="" type="checkbox"/> Pink	+2.50	•		10	Women	Molded	Rubber Tips	R
250-12-0275	<input type="checkbox"/> Clear	Anti-Scratch	<input checked="" type="checkbox"/> Pink	+2.75	•		10	Women	Molded	Rubber Tips	R
250-12-0300	<input type="checkbox"/> Clear	Anti-Scratch	<input checked="" type="checkbox"/> Pink	+3.00	•		10	Women	Molded	Rubber Tips	R

C = **WARNING:** Cancer - www.P65Warnings.ca.gov

R = **WARNING:** Reproductive Harm - www.P65Warnings.ca.gov

CR = **WARNING:** Cancer and Reproductive Harm - www.P65Warnings.ca.gov



bouton

Semi-Rimless WRAPAROUND LENS



Scan it



RUBBER NOSE BRIDGE

MEETS ANSI Z87.1+

ADVERSARY™
250-28

Popular wraparound design fits a variety of users



NEW

MEETS ANSI Z87.1+

XTRICATE™
250-59

Comfortable design and sporty styling with the ultimate in fog protection



NEW

NARROW FIT

MEETS ANSI Z87.1+

XTRICATE-C™
250-58

Narrow fit version of Xtricate

Adversary™

STANDARDS MET

STYLE	LENS	COATING	FRAME	ANSI Z801+	CSA Z94.3	BASE CURVE	FIT	BRIDGE	TEMPLE	PROP 65
250-28-0000	Clear	Anti-Scratch	Black	•		8	Round	Rubber	Bayonet, Rubber Tips	⚠ R
250-28-0001	Gray	Anti-Scratch	Black	•		8	Round	Rubber	Bayonet, Rubber Tips	⚠ R
250-28-0002	I/O	Anti-Scratch	Black	•		8	Round	Rubber	Bayonet, Rubber Tips	⚠ R
250-28-0003	Light Blue	Anti-Scratch	Black	•		8	Round	Rubber	Bayonet, Rubber Tips	⚠ R
250-28-0006	Silver Mirror	Anti-Scratch	Black	•		8	Round	Rubber	Bayonet, Rubber Tips	⚠ R
250-28-0009	Amber	Anti-Scratch	Black	•		8	Round	Rubber	Bayonet, Rubber Tips	⚠ R
250-28-0020	Clear	Anti-Scratch / Anti-Fog	Black	•		8	Round	Rubber	Bayonet, Rubber Tips	⚠ R
250-28-0021	Gray	Anti-Scratch / Anti-Fog	Black	•		8	Round	Rubber	Bayonet, Rubber Tips	⚠ R
Xtricate™										
250-59-0520	Clear	FogLess® 3Sixty™	Dark Blue	•		8.5	Universal	Rubber	Bayonet, Rubber Tips	⚠ R
250-59-0521	Gray/Green	FogLess® 3Sixty™	Dark Blue	•		8.5	Universal	Rubber	Bayonet, Rubber Tips	⚠ R
250-59-0551	Light Gray	FogLess® 3Sixty™	Dark Blue	•		8.5	Universal	Rubber	Bayonet, Rubber Tips	⚠ R
Xtricate-C™										
250-58-0520	Clear	FogLess® 3Sixty™	Green	•		8.5	Narrow	Rubber	Bayonet, Rubber Tips	⚠ R
250-58-0521	Gray/Green	FogLess® 3Sixty™	Green	•		8.5	Narrow	Rubber	Bayonet, Rubber Tips	⚠ R
250-58-0551	Light Gray	FogLess® 3Sixty™	Green	•		8.5	Narrow	Rubber	Bayonet, Rubber Tips	⚠ R

C = ⚠ WARNING: Cancer - www.P65Warnings.ca.gov

R = ⚠ WARNING: Reproductive Harm - www.P65Warnings.ca.gov

C&R = ⚠ WARNING: Cancer and Reproductive Harm - www.P65Warnings.ca.gov



bouton

WRAPAROUND DESIGN FITS A VARIETY OF USERS



Scan it



HI-VOLTAGE AC™
250-21

Contemporary styling with bayonet temples for excellent fit

RUBBER NOSE BRIDGE

MEETS ANSI Z87.1+



HI-VOLTAGE ARC™
250-24

Economical eye protection with adjustable length temples

ADJUSTABLE TEMPLES

MEETS ANSI Z87.1+



MAG READERS™
250-25

Safety readers in a semi-rimless design

READING MAGNIFIER

MEETS ANSI Z87.1+

Hi-Voltage AC™

STANDARDS MET

STYLE	LENS	COATING	FRAME	DIOPTR	ANSI Z87.1+	CSA Z94.3	BASE CURVE	FIT	BRIDGE	TEMPLE	PROP 65
250-21-0100	<input type="checkbox"/> Clear	Anti-Scratch	<input checked="" type="checkbox"/> Blue	-	•		10	Narrow	Rubber	Bayonet, Rubber Tips	⚠️ ^R
250-21-0101	<input checked="" type="checkbox"/> Gray	Anti-Scratch	<input checked="" type="checkbox"/> Blue	-	•		10	Narrow	Rubber	Bayonet, Rubber Tips	⚠️ ^R
250-21-0102	<input checked="" type="checkbox"/> I/O	Anti-Scratch	<input checked="" type="checkbox"/> Blue	-	•		10	Narrow	Rubber	Bayonet, Rubber Tips	⚠️ ^R
250-21-0120	<input type="checkbox"/> Clear	Anti-Scratch / Anti-Fog	<input checked="" type="checkbox"/> Blue	-	•		10	Narrow	Rubber	Bayonet, Rubber Tips	⚠️ ^R
250-21-0400	<input type="checkbox"/> Clear	Anti-Scratch	<input checked="" type="checkbox"/> Black	-	•		10	Narrow	Rubber	Bayonet, Rubber Tips	⚠️ ^R
250-21-0401	<input checked="" type="checkbox"/> Gray	Anti-Scratch	<input checked="" type="checkbox"/> Black	-	•		10	Narrow	Rubber	Bayonet, Rubber Tips	⚠️ ^R
250-21-0402	<input checked="" type="checkbox"/> I/O	Anti-Scratch	<input checked="" type="checkbox"/> Black	-	•		10	Narrow	Rubber	Bayonet, Rubber Tips	⚠️ ^R
250-21-0403	<input checked="" type="checkbox"/> Light Blue	Anti-Scratch	<input checked="" type="checkbox"/> Black	-	•		10	Narrow	Rubber	Bayonet, Rubber Tips	⚠️ ^R
250-21-0409	<input checked="" type="checkbox"/> Amber	Anti-Scratch	<input checked="" type="checkbox"/> Black	-	•		10	Narrow	Rubber	Bayonet, Rubber Tips	⚠️ ^R
250-21-0420	<input type="checkbox"/> Clear	Anti-Scratch / Anti-Fog	<input checked="" type="checkbox"/> Black	-	•		10	Narrow	Rubber	Bayonet, Rubber Tips	⚠️ ^R
250-21-0421	<input checked="" type="checkbox"/> Gray	Anti-Scratch / Anti-Fog	<input checked="" type="checkbox"/> Black	-	•		10	Narrow	Rubber	Bayonet, Rubber Tips	⚠️ ^R
Hi-Voltage ARC™											
250-24-0000	<input type="checkbox"/> Clear	Anti-Scratch	<input checked="" type="checkbox"/> Black	-	•		4	Universal	Molded	Spatula	⚠️ ^R
250-24-0001	<input checked="" type="checkbox"/> Gray	Anti-Scratch	<input checked="" type="checkbox"/> Black	-	•		4	Universal	Molded	Spatula	⚠️ ^R
250-24-0080	<input type="checkbox"/> Clear	Uncoated	<input checked="" type="checkbox"/> Black	-	•		4	Universal	Molded	Spatula	⚠️ ^R
250-24-0300	<input type="checkbox"/> Clear	Anti-Scratch	<input checked="" type="checkbox"/> Blue	-	•		4	Universal	Molded	Spatula	⚠️ ^R
250-24-0301	<input checked="" type="checkbox"/> Gray	Anti-Scratch	<input checked="" type="checkbox"/> Blue	-	•		4	Universal	Molded	Spatula	⚠️ ^R
Mag Readers™											
250-27-0010	<input type="checkbox"/> Clear	Anti-Scratch	<input type="checkbox"/> Clear	+1.00	•		8	Universal	Rubber	Rubber Tips	⚠️ ^R
250-27-0012	<input type="checkbox"/> Clear	Anti-Scratch	<input type="checkbox"/> Clear	+1.25	•		8	Universal	Rubber	Rubber Tips	⚠️ ^R
250-27-0015	<input type="checkbox"/> Clear	Anti-Scratch	<input type="checkbox"/> Clear	+1.50	•		8	Universal	Rubber	Rubber Tips	⚠️ ^R
250-27-0017	<input type="checkbox"/> Clear	Anti-Scratch	<input type="checkbox"/> Clear	+1.75	•		8	Universal	Rubber	Rubber Tips	⚠️ ^R
250-27-0020	<input type="checkbox"/> Clear	Anti-Scratch	<input type="checkbox"/> Clear	+2.00	•		8	Universal	Rubber	Rubber Tips	⚠️ ^R
250-27-0022	<input type="checkbox"/> Clear	Anti-Scratch	<input type="checkbox"/> Clear	+2.25	•		8	Universal	Rubber	Rubber Tips	⚠️ ^R
250-27-0025	<input type="checkbox"/> Clear	Anti-Scratch	<input type="checkbox"/> Clear	+2.50	•		8	Universal	Rubber	Rubber Tips	⚠️ ^R
250-27-0027	<input type="checkbox"/> Clear	Anti-Scratch	<input type="checkbox"/> Clear	+2.75	•		8	Universal	Rubber	Rubber Tips	⚠️ ^R
250-27-0030	<input type="checkbox"/> Clear	Anti-Scratch	<input type="checkbox"/> Clear	+3.00	•		8	Universal	Rubber	Rubber Tips	⚠️ ^R
Double Mag Readers - Top & Bottom Diopter											
250-27-0120	<input type="checkbox"/> Clear	Anti-Scratch / Anti-Fog	<input checked="" type="checkbox"/> Gray	+2.00	•		8	Universal	Rubber	Rubber Tips	⚠️ ^R
250-27-0125	<input checked="" type="checkbox"/> Gray	Anti-Scratch	<input checked="" type="checkbox"/> Gray	+2.50	•		8	Universal	Rubber	Rubber Tips	⚠️ ^R
250-27-0130	<input checked="" type="checkbox"/> Gray	Anti-Scratch	<input checked="" type="checkbox"/> Gray	+3.00	•		8	Universal	Rubber	Rubber Tips	⚠️ ^R

C=⚠️ **WARNING:** Cancer - www.P65Warnings.ca.gov R=⚠️ **WARNING:** Reproductive Harm - www.P65Warnings.ca.gov C&R=⚠️ **WARNING:** Cancer and Reproductive Harm - www.P65Warnings.ca.gov



Scan it

bouton

Over-the-glass FIT OVER PRESCRIPTION EYEWEAR



SCOUT™
250-99

Popular visitor spec designed to fit over all personal glasses

MEETS ANSI
Z87.1+



RANGER™
250-37

Slimmer design fits over smaller personal eyewear

MEETS ANSI
Z87.1+



ZENON Z28™
250-03

OTG design with adjustable length temples

MEETS ANSI
Z87.1+



OVERSITE™
250-98

Fully adjustable OTG design for a customized fit

MEETS ANSI
Z87.1+

Scout™

STANDARDS MET

STYLE	LENS	COATING	FRAME	ANSI Z87.1+	CSA Z94.3	BASE CURVE	FIT	BRIDGE	TEMPLE	PROP 65
250-99-0900	□ Clear	Anti-Scratch	□ Clear	•	•	4	Over-The-Glass	Molded	Spatula	⚠ ^R
250-99-0901	■ Gray	Anti-Scratch	■ Gray	•	•	4	Over-The-Glass	Molded	Spatula	⚠ ^R
250-99-0980	□ Clear	Uncoated	□ Clear	•	•	4	Over-The-Glass	Molded	Spatula	⚠ ^R
Ranger™										
250-37-0900	□ Clear	Anti-Scratch	□ Clear	•	•	6	Over-The-Glass	Molded	Spatula	⚠ ^R
250-37-0980	□ Clear	Uncoated	□ Clear	•	•	6	Over-The-Glass	Molded	Spatula	⚠ ^R
Zenon Z28™										
250-03-0000	□ Clear	Anti-Scratch	■ Black	•	•	4	Over-The-Glass	Molded	Spatula	⚠ ^R
250-03-0001	■ Gray	Anti-Scratch	■ Black	•	•	4	Over-The-Glass	Molded	Spatula	⚠ ^R
250-03-0080	□ Clear	Uncoated	■ Black	•	•	4	Over-The-Glass	Molded	Spatula	⚠ ^R
OverSite™										
250-98-0000	□ Clear	Anti-Scratch	■ Black	•	•	3	Over-The-Glass	Molded	Fully Adjustable, Co-Molded	⚠ ^R
250-98-0013	□ Clear	Anti-Scratch	■ Black	•	•	3	Over-The-Glass	Molded	Spatula	⚠ ^R
250-98-0020	■ IR Filter 3.0	Anti-Scratch	■ Black	•	•	3	Over-The-Glass	Molded	Fully Adjustable, Co-Molded	⚠ ^R
250-98-0024	■ IR Filter 1.7	Anti-Scratch / Anti-Fog	■ Black	•	•	3	Over-The-Glass	Molded	Spatula	⚠ ^R
250-98-0080	□ Clear	Uncoated	■ Black	•	•	3	Over-The-Glass	Molded	Fully Adjustable, Co-Molded	⚠ ^R

C = ⚠^R WARNING: Cancer - www.P65Warnings.ca.gov

R = ⚠^R WARNING: Reproductive Harm - www.P65Warnings.ca.gov

C&R = ⚠^R WARNING: Cancer and Reproductive Harm - www.P65Warnings.ca.gov



Scan it

bouton Goggles



Mission™ / 251-63

Helps provide protection from projectiles, impact and liquid splash

- Indirect vent for liquid splash protection
- Clear polycarbonate lens with anti-scratch/Fogless^{3Sixty}™ technology
- Fogless^{3Sixty}™ provides the ultimate anti-fog protection
- Two band options; adjustable elastic or neoprene strap for a comfortable fit
- Comfortable TPR seal for comfort and extended use
- ANSI Z87.1-2015 D3 Splash/Droplet Compliant



Stone™ / 251-60-0020

Helps provide protection from projectiles and impact in general use applications

- Indirect vent for liquid splash protection
- Clear polycarbonate lens with anti-scratch/ anti-fog coating with high-impact protection
- Fogless^{3Sixty}™ provides the ultimate anti-fog protection
- Adjustable elastic strap provides a comfortable fit
- Optional ANSI rated polycarbonate visor can be attached and removed in seconds

Stone™ Visor / 251-60-000V

- Providing excellent full-face protection against splash and dust when combined with the Bouton[®] Optical Stone™ goggle
- Can be attached and removed from goggle in seconds



SOLUTIONS FOR ALL APPLICATIONS

bouton

NEW



MEETS ANSI
Z87.1+

MISSION™
251-63

Helps provide protection from projectiles, impact and liquid splash

VISOR SOLD SEPARATELY



MEETS ANSI
Z87.1+

STONE™
251-60

Optional visor attachment for face protection



MEETS ANSI
Z87.1+

MEETS CSA
Z94.3

CONTEMPO™
251-5300

Modern styling with swivel headband adjustment



MEETS ANSI
Z87.1+

FORTIS II™
251-80

Lightweight goggle with comfortable sealing properties



BASIC
248-4401

Popular design for economical applications



SOFTSIDES
248-5

Soft, flexible vinyl body molds comfortably to the face

Mission™

STANDARDS MET

STYLE	LENS	COATING	FRAME	ANSI Z87.1+	CSA Z94.3	ANSI D3 DROPLET	BASE CURVE	VENTS	FRAME MATERIAL	HEADBAND	PROP 65
251-63-0520	<input type="checkbox"/> Clear	Fogless 3Sixty™	■ Dark Green	•		•	6	Indirect ventilation	TPR	Elastic	-
251-63-0520-RHB	<input type="checkbox"/> Clear	Fogless 3Sixty™	■ Dark Green	•		•	6	Indirect ventilation	TPR	Neoprene Rubber	-
Contempo™											
251-5300-000	<input type="checkbox"/> Clear	Anti-Scratch	■ Light Blue	•			5.75	Indirect ventilation	PVC	Elastic	⚠ ^R
251-5300-400	<input type="checkbox"/> Clear	Anti-Scratch, Anti-Fog	■ Light Blue	•			5.75	Indirect ventilation	PVC	Elastic	⚠ ^R
251-5300-400-RHB	<input type="checkbox"/> Clear	Anti-Scratch, Anti-Fog	■ Light Blue	•	•		5.75	Indirect ventilation	PVC	Neoprene Rubber	⚠ ^R
251-5300-402	■ Gray	Anti-Scratch, Anti-Fog	■ Light Blue	•			5.75	Indirect ventilation	PVC	Elastic	⚠ ^R
Stone™											
251-60-0020	<input type="checkbox"/> Clear	Anti-Scratch / Fogless 3Sixty™	■ Gray	•		•	5	Indirect ventilation	PVC	Elastic	⚠ ^R
Stone™ Visor only											
251-60-000V	■ Gray	-	-	•			-	-	Polycarbonate	-	⚠ ^R
Fortis II™											
251-80-0020	<input type="checkbox"/> Clear	Anti-Scratch, Anti-Fog	■ Gray	•		•	5	Indirect ventilation	Synthetic Rubber	Elastic	⚠ ^R
251-80-0020-RHB	<input type="checkbox"/> Clear	Anti-Scratch, Anti-Fog	■ Gray	•			5	Indirect ventilation	Synthetic Rubber	Neoprene Rubber	⚠ ^R
Basic											
248-4401-300	<input type="checkbox"/> Clear	Uncoated	<input type="checkbox"/> Clear	•			Flat	Indirect ventilation	Vinyl	Elastic	⚠ ^R
248-4401-400	<input type="checkbox"/> Clear	Anti-Scratch, Anti-Fog	<input type="checkbox"/> Clear	•			Flat	Indirect ventilation	Vinyl	Elastic	⚠ ^R
248-4400-300	<input type="checkbox"/> Clear	Uncoated	<input type="checkbox"/> Clear	•			Flat	Direct ventilation	Vinyl	Elastic	⚠ ^R
Softsides											
248-5190-300B	<input type="checkbox"/> Clear	Uncoated	<input type="checkbox"/> Clear	•		•	Flat	Indirect ventilation	Vinyl	Elastic	⚠ ^R
248-5190-400B	<input type="checkbox"/> Clear	Anti-Scratch, Anti-Fog	<input type="checkbox"/> Clear	•		•	Flat	Indirect ventilation	Vinyl	Elastic	⚠ ^R
248-5090-300B	<input type="checkbox"/> Clear	Uncoated	<input type="checkbox"/> Clear	•			Flat	Direct ventilation	Vinyl	Elastic	⚠ ^R
248-5090-400B	<input type="checkbox"/> Clear	Anti-Scratch, Anti-Fog	<input type="checkbox"/> Clear	•			Flat	Direct ventilation	Vinyl	Elastic	⚠ ^R
248-5290-300B	<input type="checkbox"/> Clear	Uncoated	<input type="checkbox"/> Clear	•			Flat	Non-vented	Vinyl	Elastic	⚠ ^R
248-5290-400B	<input type="checkbox"/> Clear	Anti-Scratch, Anti-Fog	<input type="checkbox"/> Clear	•			Flat	Non-vented	Vinyl	Elastic	⚠ ^R

C = ⚠^R WARNING: Cancer - www.P65Warnings.ca.gov R = ⚠^R WARNING: Reproductive Harm - www.P65Warnings.ca.gov C&R = ⚠^R WARNING: Cancer and Reproductive Harm - www.P65Warnings.ca.gov

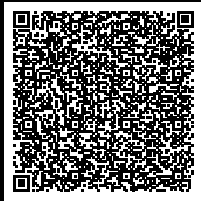

Scan it

Face Shields

PROTECT THE FACE FROM DEBRIS

PETG

(POLYETHYLENE
TEREPHTHALATE
GLYCOL)

Ideal for general sanding,
light dust and debris and
liquid splash applications.



**PETG
SAFETY VISOR**
251-01-5211



**PETG
SAFETY VISOR**
251-01-7214



**PETG
SAFETY VISOR**
251-01-5212

POLYCARBONATE

Ideal for grinding and
high impact applications.
Outperforms PETG
in a wider range of
temperatures.



**POLYCARBONATE
SAFETY VISOR
WITH ALUMINUM BINDING**
251-01-5201



**POLYCARBONATE
SAFETY VISOR
WITH CHIN CUP**
251-01-5210



**POLYCARBONATE
SAFETY VISOR**
251-01-7206

MOLDED POLYCARBONATE

Provides enhanced
options and better
peripheral vision.
Aspherical design allows
for more comfortable
movement.



**POLYCARBONATE
SAFETY VISOR**
251-01-7301



**POLYCARBONATE
SAFETY VISOR,
ASPHERICAL**
251-01-7401



**UNCOATED
POLYCARBONATE
SAFETY VISOR**
251-01-7311



bouton

STEEL WIRE MESH

Product of choice for large flying particle protection. Popular in forestry and lumber applications for scratch-proof quality, providing excellent visibility.

STEEL WIRE MESH VISOR
251-01-7701



Face Shields

STYLE NUMBER	MATERIAL	LENS	THICKNESS	SIZE	BINDING	SHAPE	STANDARDS	PROP 65
251-01-5211	PETG	☐ Clear	0.040"	8" x 15.5"	None	Flat	ANSI Z87	
251-01-7214	PETG	☐ Clear	0.040"	8" x 15.5"	Aluminum	Curved	ANSI Z87	
251-01-5212	PETG	■ Medium Green 23% VLT	0.040"	8" x 15.5"	None	Flat	ANSI Z87	
251-01-7213	PETG	■ Dark Green 16% VLT	0.040"	9" x 15.5"	Aluminum	Curved	ANSI Z87	
251-01-5213	PETG	■ Dark Green 16% VLT	0.040"	8" x 15.5"	None	Flat	ANSI Z87	
251-01-5201	Polycarbonate	☐ Clear	0.040"	8" x 15.5"	None	Flat	ANSI Z87+	⚠ ^R
251-01-5210	Polycarbonate with Chin Cup	☐ Clear	0.040"				ANSI Z87+	⚠ ^R
251-01-7206	Polycarbonate	☐ Clear	0.060"	8" x 15.5"	None	Flat	ANSI Z87+	⚠ ^R
251-01-7204	Polycarbonate	☐ Clear	0.040"	8" x 15.5"	Aluminum	Curved	ANSI Z87+	⚠ ^R
251-01-7301	Molded Polycarbonate	☐ Clear	0.078"	8" x 15"	None	Cylindrical	ANSI Z87+	⚠ ^R
251-01-7401	Molded Polycarbonate	☐ Clear	0.078"	8" x 15"	None	Aspherical	ANSI Z87+	⚠ ^R
251-01-7311	Molded Polycarbonate	■ Medium Green 23% VLT	0.078"	8" x 15"	None	Cylindrical	ANSI Z87+	⚠ ^R
251-01-7312	Molded Polycarbonate	■ Dark Green 16% VLT	0.078"	8" x 15"	None	Cylindrical	ANSI Z87+	⚠ ^R
251-01-7313	Molded Polycarbonate	■ IR Filter 3.0	0.078"	8" x 15"	None	Cylindrical	ANSI Z87+	⚠ ^R
251-01-7315	Molded Polycarbonate	■ IR Filter 5.0	0.078"	8" x 15"	None	Cylindrical	ANSI Z87+	⚠ ^R
251-01-7701	Steel Wire Mesh	----	----	8" x 15.5"	Aluminum	Cylindrical	ANSI Z87	⚠ ^R

R = ⚠ **WARNING:** Reproductive Harm - www.P65Warnings.ca.gov

Headgear

- Provides crown protection in grinding applications

STYLE NUMBER	STYLE	HOLE PATTERN	COLOR
251-01-5200	Premium Fine Tooth Ratchet	Universal	■ Blue
251-01-5400	Economy Ratchet	Universal	■ Blue



251-01-5400

Face Shield Brackets

- Enable the attachment of a safety visor to a hard hat

STYLE NUMBER	COMPATIBLE WITH	HOLE PATTERN	MATERIAL	STANDARDS
251-01-5271	Cap Style	Universal	Aluminum	ANSI Z871-2015
251-01-5270	Full Brim	Universal	Aluminum	ANSI Z871-2015
251-01-5230	Cap Style	Universal	Plastic	ANSI Z871-2015
251-01-5225	Cap Style	Universal	Plastic	ANSI Z871+CSA Z94.3
251-EPB102	Full Brim	Universal	Plastic, Dielectric	ANSI Z871-2015



251-01-5230

251-01-5225

251-EPB102



Accessories



Lens Cleaning Towelette Dispenser

STYLE NUMBER	CLEANING FUNCTION	MATERIALS	RESTRICTIONS	WALL MOUNT	PACKAGING
252-LCT100	Anti-Fog, Anti-Static, Anti-Streaking	Pre-Moistened Towelettes	None	Yes	100 individual towelettes, 10 dispensers per case

Lens Cleaning Station

252-LCS08	Anti-Fog, Anti-Static, Alcohol-Free	Spray Cleaner & Lint-free Tissues	None	Yes	8 oz. bottle & two 300-count tissue boxes, 8 stations per case
-----------	-------------------------------------	-----------------------------------	------	-----	--

Fog Buster

252-FB30	Anti-Fog	Pre-Moistened Towelettes	Mirrored or Anti-Reflective Coated	No	30 applications per box, 6 boxes per case
----------	----------	--------------------------	------------------------------------	----	---



Universal Flex Sideshields

- Weaves through the temple for added side protection
- Molded to a bendable softness
- Temple will still fold correctly
- No parts or tools required
- Meets ANSI Z87.1+ requirements

STYLE NUMBER	COLOR
252-FX-0001	<input type="checkbox"/> Clear

Patented product of Vision Aid



Black Neck Cords

- Keeps glasses close at hand for a safer workplace

STYLE NUMBER	
252-L401	Rugged Nylon
252-L404	Economy Slim Nylon
252-L407	Adjustable Sports Cord

Body PROTECTION

Environmental and workplace hazards determine the type and level of body protection needed to mitigate on-the-job risks. PIP® protective clothing is designed to help prevent injury caused by:



VISIBILITY



INCLEMENT
WEATHER



CHEMICAL &
LIQUID SPLASH



FLAME AND
EXCESSIVE HEAT



ARC
FLASH



VIRAL AND
BLOODBORNE
PATHOGENS



DUST AND
PARTICULATES



DIRT AND GENERAL
DEBRIS

146

HI-VIS APPAREL reduces the risk associated with poor visibility and is categorized under ANSI/ISEA 107-2020 performance classes for Off-Road Use, Roadway Use, Public Safety and ANSI Class E.

167

RAINWEAR & SPLASHWEAR are designed to protect workers against liquid splash and contaminants, defend against heavy rain and provide splash protection in pressure washing applications.

179

APRONS & SLEEVES serve as barriers against many potential risks. Depending on the style, they can offer cut protection, heat protection, protection against liquid splashes, light sprays and general grime. They also offer protection from debris found in everyday work.

181

FLAME RESISTANT & ARC RATED CLOTHING deliver flame and thermal protection and either resist ignition or self-extinguish when ignited, minimizing incurred burns. Clothing for various applications meet:

- > Flame resistant and ARC rated standards for ASTM F1506/NFPA 70E
- > Flash fire protection standards for NFPA 2112
- > Dual certification to NFPA 70E and NFPA 2112 that's tested and certified by a third-party

185

DISPOSABLE CLOTHING provides workers with different levels of protection based on the type of hazard and application, such as liquid sprays and light splashes. Disposable clothing can also serve as a chemical barrier, provide flame resistance and be tailored based on particulate size and type. Clothing for various applications meet:

- > Anti-static standards for NFPA 701/NFPA 99
- > Flame test standards for CFR 710
- > ASTM 1670/1671 for viral and bloodborne pathogens
- > ASTM F739 / F903 for many chemicals

199

FOOT PROTECTION offers multiple levels of defense for a variety of work conditions, ranging from sprays and splashes during light-duty or recreational use, to increased coverage during inclement weather and heavy-duty impact with compression protection when the threat of injury is present.

SECTION:

Hi-Visibility Apparel

This section features high visibility clothing that is essential to not only protect workers in high traffic and situations with complex backgrounds, but also when the easy identification of emergency personnel is needed. That is why PIP® offers hi-vis apparel that either meets the ANSI/ISEA 107-2020 standard for all types and classes or is made from ANSI-compliant materials. Multiple fabrics, coverage options and features ensure that PIP's full-body PPE keeps workers both comfortable and protected from common hazards.

ANSI 107 – HIGH VISIBILITY

PIP® hi-vis clothing provides enhanced visibility for workers based on the following performance classes:



OFF-ROAD USE

ANSI 107 TYPE O CLASS 1

Garments that provide added visibility to workers not exposed to traffic.



ROADWAY USE

ANSI 107 TYPE R CLASS 2 & 3

Vests, shirts, sweatshirts and jackets that enhance the visibility of workers who are exposed to traffic and working in complex backgrounds.



LOW
VISIBILITY



HARSH WEATHER
CONDITIONS



HIGH TRAFFIC
SITUATIONS



COMPLEX BACKGROUNDS



UV
EXPOSURE



PUBLIC SAFETY

ANSI 107 TYPE P CLASS 2 & 3

Vests and jackets that increase visibility for emergency and incident responders as well as law enforcement personnel in both roadway and off-road environments.



CLASS E APPAREL

ANSI 107 CLASS E

Includes pants, bib overalls and gaiters. These garments are not compliant when worn alone, but when combined with Class 2 apparel, are Class 3 compliant. The combination of Class E apparel with any compliant garment will enhance the visibility of the wearer.



ASTM D6413 SELF-EXTINGUISHING

PIP® self-extinguishing treated garments will self-extinguish within a given amount of time if accidentally exposed to flame, in accordance with ASTM D6413. Once removed from the ignition source, the material will not continue to burn and will self-extinguish.

Compliance is determined by the average results from five controlled tests, where the material is exposed to flame for 12 seconds. The results are measured by flame, after-flame, afterglow and char length. Samples must have an average char length below 5". These garments are not for use where there is risk of ARC flash or flash fire.



Great Value Vests

Engineered value vests made with breathable mesh and lightweight fabric



Scan it

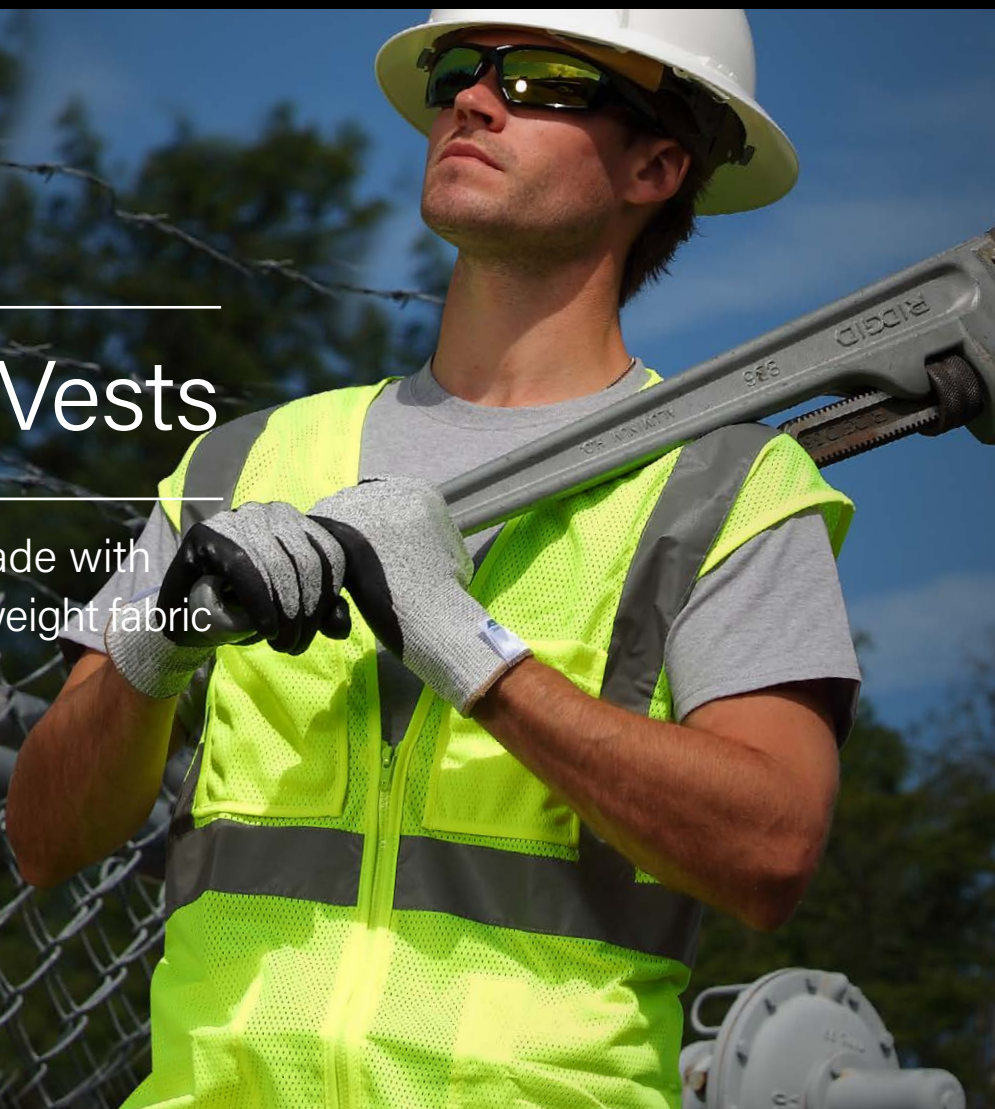



Upper and lower pockets keep equipment and devices accessible and secure

STYLE NUMBER	HI-VIS COLOR	ANSI 107	FABRIC	CLOSURE	POCKETS	REFLECTIVE	SIZE
303-HSVPLY 303-HSVPOR	Hi-Vis Yellow Hi-Vis Orange	Type R Class 3	Mesh	Zipper	2	2" Two-Tone Sewn-On	S - 5XL
303-HSVELY 303-HSVEOR	Hi-Vis Yellow Hi-Vis Orange	Type R Class 3	Mesh	Hook & Loop	4	2" Silver Sewn-On	S - 6XL
303-MVGZ4P-LY 303-MVGZ4P-OR	Hi-Vis Yellow Hi-Vis Orange	Type R Class 3	Mesh	Zipper	4	2" Silver Sewn-On	S - 5XL
47302 47303	Hi-Vis Yellow Hi-Vis Orange	Type R Class 3	Mesh	Zipper	3	2" Silver Sewn-On	M - 5XL
303-V100LY	Hi-Vis Yellow	Type R Class 3	Mesh	Zipper	1	2" Silver	S/M, L/XL, 2X/3X, 4X/5X, 6X/7X
302-MVLY 302-MVOR	Hi-Vis Yellow Hi-Vis Orange	Type R Class 2	Mesh	Zipper	2	2" Two-Tone Sewn-On	S - 5XL
302-V100LY 302-V100OR	Hi-Vis Yellow Hi-Vis Orange	Type R Class 2	Mesh	Zipper	1	2" Silver Sewn-On	S/M, L/XL, 2X/3X, 4X/5X, 6X/7X
302-V200LY 302-V200OR	Hi-Vis Yellow Hi-Vis Orange	Type R Class 2	Mesh	Zipper	2	2" Silver Sewn-On	S/M, L/XL, 2X/3X, 4X/5X, 6X/7X
302-MVGLY 302-MVGOR	Hi-Vis Yellow Hi-Vis Orange	Type R Class 2	Mesh	Hook & Loop	0	2" Silver Sewn-On	S - 5XL
302-MVGZLY 302-MVGZOR	Hi-Vis Yellow Hi-Vis Orange	Type R Class 2	Mesh	Zipper	0	2" Silver Sewn-On	S - 5XL
302-0702-LY 302-0702-OR	Hi-Vis Yellow Hi-Vis Orange	Type R Class 2	Mesh	Hook & Loop	2	2" Silver Sewn-On	S - 5XL
302-0702Z-LY 302-0702Z-OR	Hi-Vis Yellow Hi-Vis Orange	Type R Class 2	Mesh	Zipper	2	2" Silver Sewn-On	S - 6XL
302-MVGZ4PLY 302-MVGZ4POR	Hi-Vis Yellow Hi-Vis Orange	Type R Class 2	Mesh	Zipper	4	2" Silver Sewn-On	S - 5XL
47207 47208	Hi-Vis Yellow Hi-Vis Orange	Type R Class 2	Mesh	Hook & Loop	2	2" Silver Sewn-On	S/M, L/XL
302-WCENGLY 302-WCENGOR	Hi-Vis Yellow Hi-Vis Orange	Type R Class 2	Solid	Hook & Loop	0	2" Silver Sewn-On	S - 5XL
302-WCENGZLY 302-WCENGZOR	Hi-Vis Yellow Hi-Vis Orange	Type R Class 2	Solid	Zipper	0	2" Silver Sewn-On	M - 5XL
302-V205LY 302-V205OR	Hi-Vis Yellow Hi-Vis Orange	Type R Class 2	Mesh	Zipper	2	2" Silver Sewn-On	S/M, L/XL, 2X/3X, 4X/5X, 6X/7X





Five-Point Breakaway Vests

For additional safety
around extreme
traffic hazards,
moving machinery
or equipment



Scan it





X-back styles meet CAN/CSA Z96

Five-Point Breakaway Vests

STYLE NUMBER	HI-VIS COLOR	ANSI 107	FABRIC	CLOSURE	POCKETS	REFLECTIVE	SIZE
302-V205LY 302-V205OR	Hi-Vis Yellow Hi-Vis Orange	Type R Class 2	Mesh	Hook & Loop	2	2" Silver Sewn-On	S/M, L/XL, 2X/3X, 4X/5X, 6X/7X
302-5PMVLY 302-5PMVOR	Hi-Vis Yellow Hi-Vis Orange	Type R Class 2	Mesh	Hook & Loop	3	2" Silver Sewn-On	S-5XL
302-5PVLY 302-5PVOR	Hi-Vis Yellow Hi-Vis Orange	Type R Class 2	Solid	Hook & Loop	3	2" Silver Sewn-On	S-5XL
302-0212-LY 302-0212-OR	Hi-Vis Yellow Hi-Vis Orange	Type R Class 2	Mesh	Hook & Loop	5	2" Two-Tone Sewn-On	S-5XL
303-5PMTT-LY 303-5PMTT-OR	Hi-Vis Yellow Hi-Vis Orange	Type R Class 3	Mesh	Hook & Loop	5	2" Two-Tone Sewn-On	S-5XL
305-5PVFRLY 305-5PVFROR	Hi-Vis Yellow Hi-Vis Orange	Type R Class 3	Solid	Hook & Loop	4	2" Silver Sewn-On	S/M, L/XL, 2XL/3XL, 4XL/5XL
302-0505-LY 302-0505-OR	Hi-Vis Yellow Hi-Vis Orange	Type R Class 2	Mesh / Solid	Zipper	11	2" Two-Tone	S-5XL

Five-Point Breakaway X-Back Vests

302-0210-LY 302-0210-OR	Hi-Vis Yellow Hi-Vis Orange	Type R Class 2	Mesh	Hook & Loop	3	2" Silver Sewn-On	S-5XL
302-0211-LY 302-0211-OR	Hi-Vis Yellow Hi-Vis Orange	Type R Class 2	Mesh	Hook & Loop	4	2" Two-Tone Sewn-On	S-6XL
47213	Hi-Vis Yellow	Type R Class 2	Mesh	Hook & Loop	3	2" Two-Tone Sewn-On	M-5XL
47214	Hi-Vis Orange	Type R Class 2	Mesh	Hook & Loop	3	2" Two-Tone Sewn-On	M-4XL

Expandable Five-Point Breakaway X-Back Vest

47200 47201	Hi-Vis Yellow Hi-Vis Orange	Type R Class 2	Mesh	Hook & Loop	3	2" Silver Sewn-On	One Size
----------------	--------------------------------	----------------	------	-------------	---	-------------------	----------

Expandable Five-Point Breakaway Vest

302-0590LY 302-0590OR	Hi-Vis Yellow Hi-Vis Orange	Type R Class 2	Mesh	Breakaway Zipper	3	2" Two-Tone Sewn-On	M/XL, 2XL/5XL
--------------------------	--------------------------------	----------------	------	------------------	---	---------------------	---------------



Surveyor & Specialty Vests





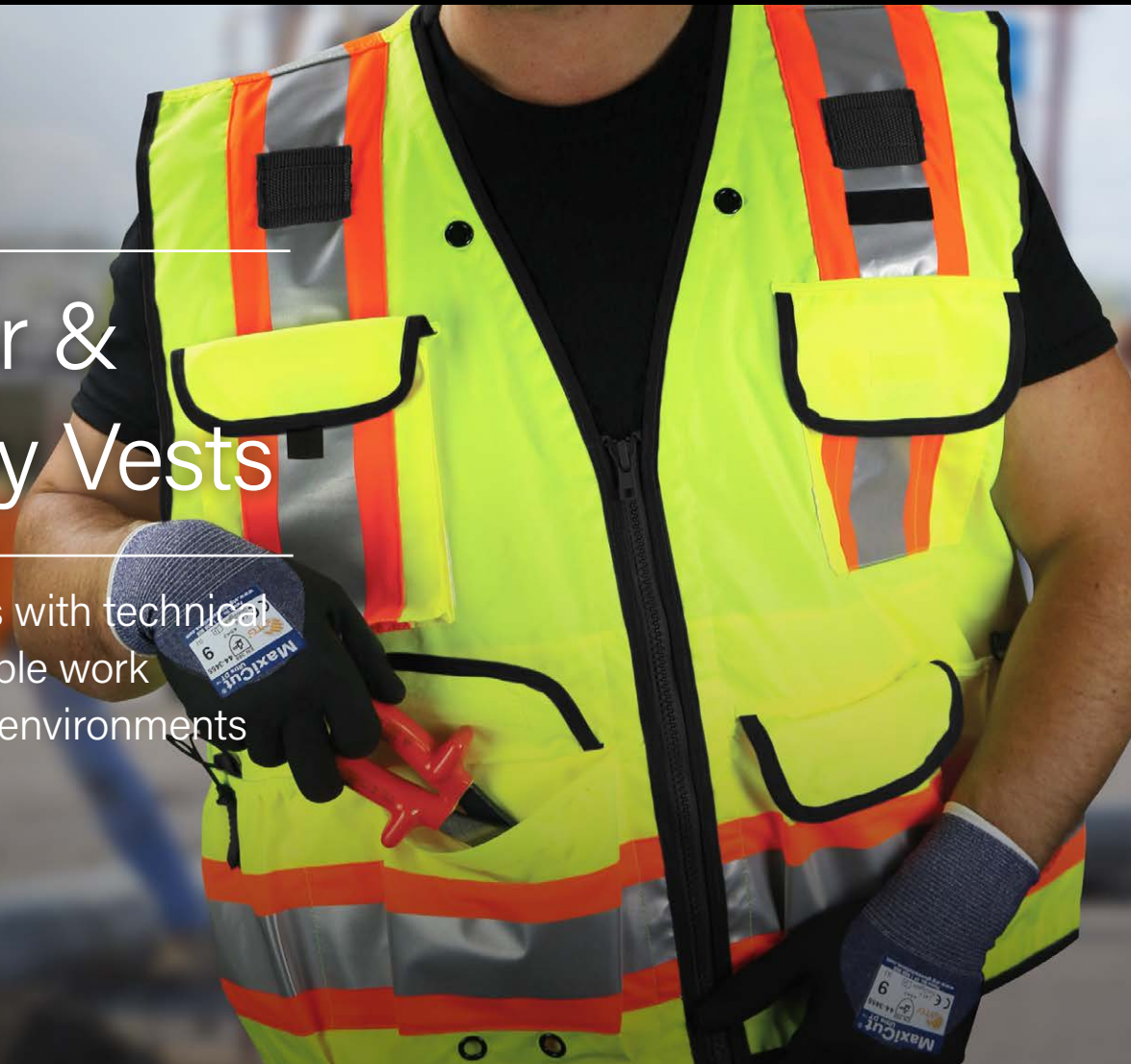

Heavy-duty vests with technical features for multiple work applications and environments



Scan it





STYLE NUMBER	HI-VIS COLOR	ANSI 107	FABRIC	CLOSURE	POCKETS	REFLECTIVE	SIZE
 302-0670T-LY 302-0670T-OR	Hi-Vis Yellow Hi-Vis Orange	Type R Class 2	Mesh / Ripstop	Zipper	12	2" Two-Tone	S-5XL
302-0750-LY 302-0750-OR	Hi-Vis Yellow Hi-Vis Orange	Type R Class 2	Mesh	Zipper	5 & ID	2" Silver	S-5XL
302-0710B-LY	Hi-Vis Yellow / Black	Type R Class 2	Mesh	Zipper	5	2" Silver	S-5XL
302-0500-YEL 302-0500-ORG	Hi-Vis Yellow Hi-Vis Orange	Type R Class 2	Mesh / Solid	Zipper	11	2" Two-Tone	S-7XL
302-0500M-LY 302-0500M-OR	Hi-Vis Yellow Hi-Vis Orange	Type R Class 2	Mesh	Zipper	11	2" Two-Tone	S-5XL
302-0500S-YEL 302-0500S-ORG	Hi-Vis Yellow Hi-Vis Orange	Type R Class 2	Solid	Zipper	11	2" Two-Tone	S-5XL
 302-0500D-LY 302-0500D-OR	Hi-Vis Yellow Hi-Vis Orange	Type R Class 2	Mesh / Solid	Zipper	11 & ID	2" Two-Tone	S-5XL
302-0700-LY 302-0700-OR	Hi-Vis Yellow Hi-Vis Orange	Type R Class 2	Mesh / Solid	Zipper	10 & ID	2" Two-Tone	S-5XL
 302-0650D-LY 302-0650D-OR	Hi-Vis Yellow/Black Hi-Vis Orange/Black	Type R Class 2	Mesh / Ripstop	Zipper	11 & ID	2" Two-Tone	S-5XL
 302-0800D-LY 302-0800D-OR	Hi-Vis Yellow Hi-Vis Orange	Type R Class 2	Mesh / Solid	Zipper	11 & ID	2" Two-Tone	S-5XL
302-0900-LY 302-0900-OR	Hi-Vis Yellow Hi-Vis Orange	Type R Class 2	Mesh / Ripstop	Zipper	15	2" Two-Tone Heat Applied	M-5XL
303-0710B-LY	Hi-Vis Yellow / Black	Type R Class 3	Mesh	Zipper	5	2" Silver	S-5XL
303-0500-LY 303-0500-OR	Hi-Vis Yellow Hi-Vis Orange	Type R Class 3	Mesh / Solid	Zipper	11	2" Two-Tone	S-6XL
303-0500M-LY 303-0500M-OR	Hi-Vis Yellow Hi-Vis Orange	Type R Class 3	Mesh	Zipper	11	2" Two-Tone	S-5XL
305-SVZSE-LY	Hi-Vis Yellow	Type R Class 3	Mesh	Zipper	5	2" Two-Tone	S-5XL
 303-0800D-LY 303-0800D-OR	Hi-Vis Yellow Hi-Vis Orange	Type R Class 3	Mesh / Solid	Zipper	11 & ID	2" Two-Tone	S-5XL
 302-0800D-BK	Black with Hi-Vis Lime Yellow Trim	Type O Class 1	Mesh / Ripstop	Zipper	11 & ID	2" Silver	S-5XL
 302-0600D-LY 302-0600D-OR	Hi-Vis Yellow Hi-Vis Orange	Type R Class 2	Mesh	Zipper	2	2" Two-Tone	S-5XL
302-USV5LY 302-USV5OR	Hi-Vis Yellow Hi-Vis Orange	Type R Class 2	Mesh	Zipper	3	2" Two-Tone	ONE SIZE
302-MVZPLY 302-MVZPOR	Hi-Vis Yellow Hi-Vis Orange	Type R Class 2	Mesh	Zipper	6	2" Two-Tone	S-5XL
302-MVZT-LY 302-MVZT-OR	Hi-Vis Yellow Hi-Vis Orange	Type R Class 2	Mesh	Zipper	6	2" Two-Tone	S-5XL

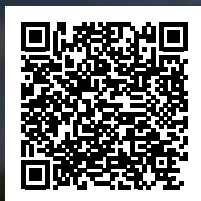

Scan it



Womens Vests



Premium, breathable protection designed and sized specifically for women



47207



WOMEN'S FIT

WITH ADJUSTABLE WAIST



302-0512



303-0313



STYLE NUMBER	HI-VIS COLOR	ANSI 107	FABRIC	CLOSURE	POCKETS	REFLECTIVE	SIZE
302-0312-LY	Hi-Vis Yellow	Type R Class 2	Mesh / Solid	Zipper	3	2" Two-Tone	S - 2XL
303-0313-LY	Hi-Vis Yellow	Type R Class 3	Mesh / Solid	Zipper	3	2" Two-Tone	S - 2XL
302-0512-LY	Hi-Vis Yellow	Type R Class 2	Mesh / Solid	Zipper	11	Two-Tone	S-3XL
302-0512-OR	Hi-Vis Orange						
303-0513-LY	Hi-Vis Yellow	Type R Class 3	Mesh / Solid	Zipper	11	Two-Tone	S-3XL
303-0513-OR	Hi-Vis Orange						
47207	Hi-Vis Yellow	Type R Class 2	Mesh	Hook & loop	2	2" Silver	S/M, L/XL
47208	Hi-Vis Orange						



Self-Extinguishing Vests

Scan it

Value SE Vests



Premium SE Vests with FR Reflective Tape



STYLE NUMBER	HI-VIS COLOR	ANSI 107	FABRIC	CLOSURE	POCKETS	REFLECTIVE	SIZE
47217 47218	Hi-Vis Yellow Hi-Vis Orange	Type R Class 2	Treated Mesh	Hook & Loop	3	2" Silver	M-4XL
305-MVZSE-LY 305-MVZSE-OR	Hi-Vis Yellow Hi-Vis Orange	Type R Class 2	Treated Mesh	Zipper	2	2" Two-Tone	S-5XL
47308	Hi-Vis Yellow	Type R Class 3	Treated Mesh	Hook & Loop	3	2" Silver	M-5XL
305-SVZSE-LY	Hi-Vis Yellow	Type R Class 3	Treated Mesh	Zipper	5	2" Two-Tone	S-5XL
305-MVFRLY 305-MVFROR	Hi-Vis Yellow Hi-Vis Orange	Type R Class 2	Treated Mesh	Hook & Loop	2	2" FR Two-Tone	S/M/L/XL/2X/3X/4X/5X
305-5PVFRLY 305-5PVFROR	Hi-Vis Yellow Hi-Vis Orange	Type R Class 2	Treated Solid	Hook & Loop	4	2" FR Silver	S/M/L/XL/2X/3X/4X/5X
305-HSSVFRLY	Hi-Vis Yellow	Type R Class 3	Treated Solid	Hook & Loop	0	2" FR Silver	S/M/L/XL/2X/3X/4X/5X
305-HSVPFRLY 305-HSVPFROR	Hi-Vis Yellow Hi-Vis Orange	Type R Class 3	Treated Mesh	Hook & Loop	2	2" FR Two-Tone	S/M/L/XL/2X/3X/4X/5X

This garment is not to be used where exposure to ARC Flash or Flash Fire is possible.



Public Safety Vests

ANSI 107 Type P Class 2
safety and emergency
management vests
provide custom visibility
in high-risk situations



Scan it





PERFORMANCE CLASS 2 TYPE P

The performance Class 2 Type P standard was developed to provide enhanced visibility for emergency responders and law enforcement personnel in both roadway and off-road environments. All vests meet the revised ANSI/ISEA 107-2020 standard.



302-PSV-RED



302-PSV-BLU



302-PSV-BLK



302-PSV-GRN

STYLE NUMBER	LOGO	HI-VIS COLOR	ANSI 107	FABRIC	CLOSURE	POCKETS	REFLECTIVE	SIZE
302-PSV-RED	"Fire" Logo	Red	Type P Class 2	Mesh / Solid	Breakaway Zipper	2	1" Split Trim	M/XL, 2X/5X
302-PSV-RED-NL	No Logo	Red	Type P Class 2	Mesh / Solid	Breakaway Zipper	2	1" Split Trim	M/XL, 2X/5X
302-PSV-BLU	"Police" Logo	Blue	Type P Class 2	Mesh / Solid	Breakaway Zipper	2	1" Split Trim	M/XL, 2X/5X
302-PSV-BLU-NL	No Logo	Blue	Type P Class 2	Mesh / Solid	Breakaway Zipper	2	1" Split Trim	M/XL, 2X/5X
302-PSV-BLK	"Security" Logo	Black	Type P Class 2	Mesh / Solid	Breakaway Zipper	2	1" Split Trim	M/XL, 2X/5X
302-PSV-BLK-NL	No Logo	Black	Type P Class 2	Mesh / Solid	Breakaway Zipper	2	1" Split Trim	M/XL, 2X/5X
302-PSV-GRN	No Logo	Green	Type P Class 2	Mesh / Solid	Breakaway Zipper	2 & ID	1" Split Trim	M/XL, 2X/5X

Five-point breakaway
for safety around extreme traffic hazards



Incident Command Vests

Non-ANSI vests available in 23 different colors



300-1508

POCKETS
4
ID POCKETS



300-2504

POCKETS
4
ID POCKETS



300-2511

POCKETS
4
ID POCKETS



FRONT & BACK
ID POCKETS

STYLE NUMBER	HI-VIS COLOR	ANSI 107	FABRIC	CLOSURE	POCKETS	REFLECTIVE	SIZE
300-1502	Black	Non-ANSI	100% Polyester	Hook & Loop	4	1" White Gloss	M/XL, 2X/3X
300-1504	Royal Blue	Non-ANSI	100% Polyester	Hook & Loop	4	1" White Gloss	M/XL, 2X/3X
300-1505	Kelly Green	Non-ANSI	100% Polyester	Hook & Loop	4	1" White Gloss	M/XL, 2X/3X
300-1507	Orange	Non-ANSI	100% Polyester	Hook & Loop	4	1" White Gloss	M/XL, 2X/3X
300-1508	Red	Non-ANSI	100% Polyester	Hook & Loop	4	1" White Gloss	M/XL, 2X/3X
300-1510	Yellow	Non-ANSI	100% Polyester	Hook & Loop	4	1" White Gloss	M/XL, 2X/3X
300-1511	White	Non-ANSI	100% Polyester	Hook & Loop	4	1" Yellow Gloss	M/XL, 2X/3X
300-1516	Pink	Non-ANSI	100% Polyester	Hook & Loop	4	1" White Gloss	M/XL, 2X/3X
300-2501	Purple	Non-ANSI	Polyester / Cotton	Hook & Loop	4	1" White Gloss	M/XL, 2X/3X, 4X/5X
300-2502	Black	Non-ANSI	Polyester / Cotton	Hook & Loop	4	1" White Gloss	M/XL, 2X/3X, 4X/5X
300-2503	Dark Blue	Non-ANSI	Polyester / Cotton	Hook & Loop	4	1" White Gloss	M/XL, 2X/3X, 4X/5X
300-2504	Royal Blue	Non-ANSI	Polyester / Cotton	Hook & Loop	4	1" White Gloss	M/XL, 2X/3X, 4X/5X
300-2505	Kelly Green	Non-ANSI	Polyester / Cotton	Hook & Loop	4	1" White Gloss	M/XL, 2X/3X, 4X/5X
300-2506	Tan	Non-ANSI	Polyester / Cotton	Hook & Loop	4	1" White Gloss	M/XL, 2X/3X, 4X/5X
300-2507	Orange	Non-ANSI	Polyester / Cotton	Hook & Loop	4	1" White Gloss	M/XL, 2X/3X, 4X/5X
300-2508	Red	Non-ANSI	Polyester / Cotton	Hook & Loop	4	1" White Gloss	M/XL, 2X/3X, 4X/5X
300-2509	Light Blue	Non-ANSI	Polyester / Cotton	Hook & Loop	4	1" White Gloss	M/XL, 2X/3X, 4X/5X
300-2510	Yellow	Non-ANSI	Polyester / Cotton	Hook & Loop	4	1" White Gloss	M/XL, 2X/3X, 4X/5X
300-2511	White	Non-ANSI	Polyester / Cotton	Hook & Loop	4	1" Yellow Gloss	M/XL, 2X/3X, 4X/5X
300-2512	Hi-Vis Orange	Non-ANSI	100% Polyester	Hook & Loop	4	1" White Gloss	M/XL, 2X/3X, 4X/5X
300-2513	Hi-Vis Yellow	Non-ANSI	100% Polyester	Hook & Loop	4	1" White Gloss	M/XL, 2X/3X, 4X/5X
300-2514	Forest Green	Non-ANSI	Polyester / Cotton	Hook & Loop	4	1" White Gloss	M/XL, 2X/3X, 4X/5X
300-2515	Gray	Non-ANSI	Polyester / Cotton	Hook & Loop	4	1" White Gloss	M/XL, 2X/3X, 4X/5X



Enhanced Visibility Safety Vests

Color enhanced for an additional level of safety in low-risk activities



300-1000-BL

300-1000-RD

300-0800-LY

300-0900

300-EVOR-E

300-EVOR-P

STYLE NUMBER	HI-VIS COLOR	ANSI 107	FABRIC	CLOSURE	POCKETS	REFLECTIVE	SIZE
300-1000-RD 300-1000-BL	Red Blue	Non-ANSI	Mesh / Solid	Zipper	4	1" Split Trim Sewn-On	S-5XL
300-0800-LY 300-0800-OR	Hi-Vis Yellow Hi-Vis Orange	Non-ANSI	Mesh	Hook & Loop	0	-	ONE SIZE
300-0900-LY 300-0900OR	Hi-Vis Yellow Hi-Vis Orange	Non-ANSI	Mesh	Hook & Loop	0	1" Two-Tone Sewn-On	ONE SIZE
300-EVOR-E-LY 300-EVOR-E-OR	Hi-Vis Yellow Hi-Vis Orange	Non-ANSI	Mesh	Hook & Loop	1	1" Silver Sewn-On	ONE SIZE
300-EVOR-P-LY 300-EVOR-P-OR	Hi-Vis Yellow Hi-Vis Orange	Non-ANSI	Mesh	Hook & Loop	0	1-3/8" Sewn-On	ONE SIZE



Scan it

PIP | T-Shirts

Lightweight and durable t-shirts made with performance-wicking material



POCKETS
1

SEGMENTED TAPE

313-1600B

ANSI 107
TYPE/CLASS
R3



50+
UPF

310-1150B



POCKETS
1

313-CNTSP

ANSI 107
TYPE/CLASS
R3



POCKETS
1

50+
UPF

313-1390B

ANSI 107
TYPE/CLASS
R3



POCKETS
1

50+
UPF

312-1250B

ANSI 107
TYPE/CLASS
R2



POCKETS
1

313-CNTSE

ANSI 107
TYPE/CLASS
R3



POCKETS
1

TWO-TONE SEGMENTED TAPE

313-1650

ANSI 107
TYPE/CLASS
R3



ANSI Type R Class 2 Short & Long Sleeve T-Shirts

STYLE NUMBER	HI-VIS COLOR	FEATURE	SLEEVES	ANSI 107	FABRIC	POCKETS	REFLECTIVE	SIZE
312-1200-LY 312-1200-OR	Hi-Vis Yellow Hi-Vis Orange	Wicking Polyester-	Short Sleeve	Type R Class 2	Birdseye Mesh	1	2" Silver	S - 5XL
312-1250B-LY 312-1250B-OR	Hi-Vis Yellow / Black Hi-Vis Orange / Black	UV Protection, Black Bottom Front	Short Sleeve	Type R Class 2	Birdseye Mesh	1	2" Silver	S - 8XL
312-1275B-LY	Hi-Vis Yellow / Black	Black Bottom Front	Short Sleeve	Type R Class 2	Birdseye Mesh	1	2" Segmented	S - 5XL
312-1350B-LY 312-1350B-OR	Hi-Vis Yellow / Black Hi-Vis Orange / Black	UV Protection, Black Bottom Front	Long Sleeve	Type R Class 2	Birdseye Mesh	1	2" Silver	S - 6XL
312-1500B-LY	Hi-Vis Yellow / Black	Snag Resistant Pique	Short Sleeve Polo	Type R Class 2	Pique Mesh	1	2" Segmented	S - 5XL
313-1390B-LY 313-1390B-OR	Hi-Vis Yellow / Black Hi-Vis Orange / Black	Moisture Wicking, UV Protection	Long Sleeve	Type R Class 3	Birdseye Mesh	1	2" Silver	S-6XL
311-1655-BK	Black	Moisture Wicking, UV Protection	Short Sleeve	Type O Class 1	2-Layer Polypropylene / Polyester	1	2" Segmented	S-5XL
312-1610B-LY	Hi-Vis Yellow / Black	Moisture Wicking, UV Protection	Short Sleeve Polo	Type R Class 2	2-Layer Polypropylene / Polyester	1	2" Segmented	S-5XL
313-1600B-LY 313-1600B-OR	Hi-Vis Yellow / Black Hi-Vis Orange / Black	Moisture Wicking, UV Protection	Short Sleeve	Type R Class 3	2-Layer Polypropylene / Polyester	1	2" Segmented	S-5XL
313-1650-LY 313-1650-OR	Hi-Vis Yellow Hi-Vis Orange	Moisture Wicking, UV Protection	Short Sleeve	Type R Class 3	2-Layer Polypropylene / Polyester	1	2" Two-Tone	S-5XL

ANSI Type R Class 3 Short & Long Sleeve T-Shirts

313-CNTSELY 313-CNTSEOR	Hi-Vis Yellow Hi-Vis Orange	Wicking Polyester	Short Sleeve	Type R Class 3	Birdseye Mesh	1	2" Silver	S - 5XL
313-CNTSELY-PRI18WLY	Hi-Vis Yellow	Short Sleeve T-Shirt with Integrated Pritex [®] Antimicrobial Sleeve	Long Sleeve	Type R Class 3	Birdseye Mesh	1	2" Silver	S - 4XL
313-1400-LY 313-1400-OR	Hi-Vis Yellow Hi-Vis Orange	X-Back, CSA Z96	Short Sleeve	Type R Class 3	Birdseye Mesh	1	2" Silver	S - 5XL
313-CNTSPLY 313-CNTSPOR	Hi-Vis Yellow Hi-Vis Orange	Wicking Polyester	Short Sleeve	Type R Class 3	Birdseye Mesh	1	2" Two-Tone	S - 5XL
313-1300-LY 313-1300-OR	Hi-Vis Yellow Hi-Vis Orange	Wicking Polyester	Long Sleeve	Type R Class 3	Birdseye Mesh	1	2" Silver	S - 5XL
313-1280B-LY	Hi-Vis Yellow / Black	Black Bottom Front	Long Sleeve	Type R Class 3	Birdseye Mesh	1	2" Segmented	S - 5XL
313-1375B-LY	Hi-Vis Yellow / Black	UV Protection, Insect Repellent, Black Bottom Front	Long Sleeve	Type R Class 3	Birdseye Mesh	1	2" Segmented	S - 5XL

Non-ANSI Short & Long Sleeve T-Shirts - ANSI-Compliant Material

310-1100-LY 310-1100-OR	Hi-Vis Yellow Hi-Vis Orange	Wicking Polyester	Long Sleeve	Non-ANSI / ANSI Material	Birdseye Mesh	1	None	S - 5XL
310-1150B-LY	Hi-Vis Yellow with Black Trim	UV Protection, Insect Repellent	Long Sleeve	Non-ANSI / ANSI Material	Birdseye Mesh	-	None	S - 5XL
310-950B-LY	Hi-Vis Yellow with Black Trim	UV Protection, Insect Repellent	Short Sleeve	Non-ANSI / ANSI Material	Birdseye Mesh	-	None	S - 5XL
310-CNTSNLY 310-CNTSNOR	Hi-Vis Yellow Hi-Vis Orange	Wicking Polyester	Short Sleeve	Non-ANSI / ANSI Material	Birdseye Mesh	1	None	S - 5XL



ANSI
A2

PIP

DUO PRO™
ANSI 107 HI-VIS T-SHIRT WITH
INTEGRATED PROTECTIVE SLEEVES

Construction / Municipalities / Ship Yards / Recycling / HVAC

313-CNTSELY-PRI18W

- Patent-pending design
- Integrated Pritex[®] sleeves help protect against cuts, scrapes and abrasions
- Eliminates the need for a vest and keeps sleeves in place for maximum arm protection

DUO PRO™ SHORT SLEEVE T-SHIRT WITH INTEGRATED PRITEX[®] ANTIMICROBIAL SLEEVES

STYLE	SHORT SLEEVE T-SHIRT				2X1 KNIT PROTECTIVE SLEEVE			
	ANSI 107	MATERIAL	COLOR	SIZE	ANSI 105	MATERIAL	LENGTH	COLOR
313-CNTSELY- [*] PRI18W	Type R Class 3	Polyester	Hi-Vis Lime Yellow	S-5X	A2	Pritex [®]	18"	White

PUT THE DESIRED SIZE OF THE SHIRT IN PLACE OF THE ASTERISK () IN THE PART NUMBER





Sweatshirts

ANSI 107 Type R
Class 3 sweatshirts
suited for inclement
weather and various
work environments



Scan it



323-1400S



323-1385B



323-1475X-BK

Water repellent outer shell on black bottom styles

STYLE NUMBER	HI-VIS COLOR	FEATURE	ANSI 107	FABRIC	CLOSURE	POCKETS	REFLECTIVE	SIZE
323-CNSSELY	Hi-Vis Yellow	LT WT Warmth	Type R Class 3	8oz. Polyester Fleece	Pullover	0	2" Silver	M - 5XL
323-HSSELY 323-HSSEOR	Hi-Vis Yellow Hi-Vis Orange	LT WT Warmth	Type R Class 3	8oz. Polyester Fleece	Zipper	2	2" Silver	M - 5XL
323-HSSPLY	Hi-Vis Yellow	LT WT Fleece	Type R Class 3	8oz. Polyester Fleece	Zipper	2	2" Two-Tone	M - 5XL
323-1330B-LY 323-1330B-OR	Hi-Vis Yellow / Black Hi-Vis Orange / Black	Water Repellent, Black Bottom	Type R Class 3	10oz. Polyester Fleece	1/4 Zipper	2	2" Silver	S - 5XL
323-1350B-LY 323-1350B-OR	Hi-Vis Yellow / Black Hi-Vis Orange / Black	Water Repellent, Black Bottom	Type R Class 3	10oz. Polyester Fleece	Pullover	2	2" Silver	S - 5XL
323-1370B-LY 323-1370B-OR	Hi-Vis Yellow / Black Hi-Vis Orange / Black	Water Repellent, Black Bottom	Type R Class 3	10oz. Polyester Fleece	Zipper	3	2" Silver	S - 5XL
323-1385B-LY	Hi-Vis Yellow	Grid Fleece, Black Bottom, Removable Hood	Type R Class 3	8oz. Grid Fleece	Zipper	3	2" Silver	S - 5XL
323-1400S-LY	Hi-Vis Yellow / Black	Water Repellent, Reversible	Type R Class 3	10oz. Polyester Fleece / 2oz. Insulation	Zipper	2	2" Segmented	S-5XL
323-1475X-LY 323-1475X-OR	Hi-Vis Yellow Hi-Vis Orange	Removable Hood, X-Back, CSA Z96	Type R Class 3	14oz. Polyester Fleece / Grid Fleece 3-Ply	Zipper	3	2" Two-Tone	S - 5XL
323-1475X-BK	Black	Removable Hood, X-Back, CSA Z96	Type O Class 1	14oz. Polyester Fleece / Grid Fleece 3-Ply	Zipper	3	2" Two-Tone	S - 5XL



Jackets & Coats

Versatile, durable outerwear to protect workers from cold stress and serious weather conditions



Scan it

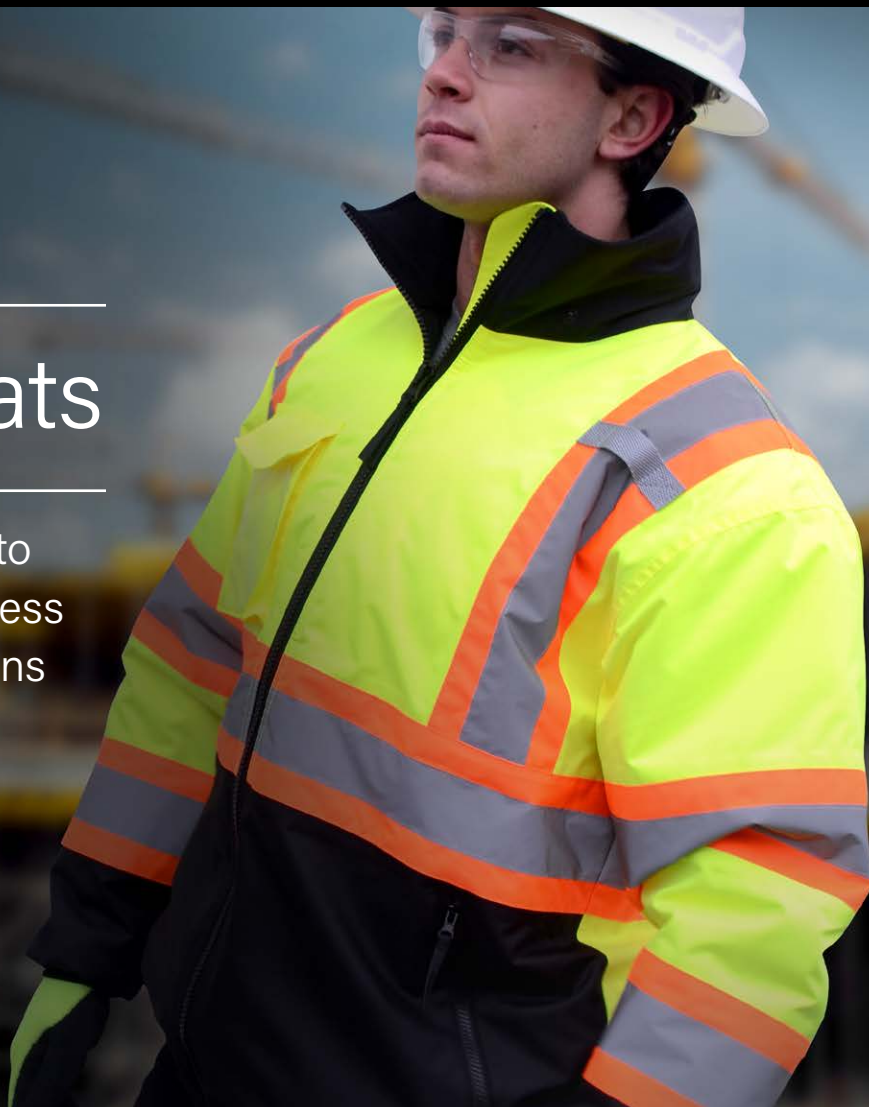



Coats and jackets that adapt to the work environment, activity and duration

Bomber Jackets - Removable Insulation

STYLE NUMBER	HI-VIS COLOR	FEATURE	ANSI 107	FABRIC	CLOSURE	POCKETS	REFLECTIVE	SIZE
333-1762-LY 333-1762-OR	Hi-Vis Yellow Hi-Vis Orange	Zip-out Fleece Liner	Type R Class 3	300 D. Polyester	Zipper	8	2" Silver	S - 6XL
333-1766-LY 333-1766-OR	Hi-Vis Yellow / Black Hi-Vis Orange / Black	Zip-out Fleece Liner, Black Bottom	Type R Class 3	300 D. Polyester	Zipper	8	2" Silver	S - 6XL
333-1770-LY 333-1770-OR	Hi-Vis Yellow / Black Hi-Vis Orange / Black	Zip-out Fleece Liner, Black Bottom, D-Ring Access	Type R Class 3	300 D. Ripstop Shell	Zipper	9	2" Silver	S - 5XL
333-1772-LY 333-1772-OR	Hi-Vis Yellow / Black Hi-Vis Orange / Black	3-in-1 Jacket, Zip-out Grid Fleece Inner, Black Bottom	Type R Class 3	150 D. Rip Stop Shell	Zipper	9	2" Two-Tone	S - 5XL
331-1772-BK	Black / Hi-Vis Trim	3-in-1 Jacket, Zip-out Grid Fleece Inner, Black Bottom	Type O Class 1	150 D. Rip Stop Shell	Zipper	9	2" Two-Tone	S - 5XL

Bomber Jackets - Fixed Insulation

333-1740-LY 333-1740-OR	Hi-Vis Yellow / Black Hi-Vis Orange / Black	Black Bottom	Type R Class 3	300 D. Polyester Shell	Zipper	6	2" Silver	S - 6XL
333-1745-LY 333-1745-OR	Hi-Vis Yellow Hi-Vis Orange	Black Bottom	Type R Class 3	300 D. Polyester Shell	Zipper	7	2" Two-Tone	S - 5XL
333-1745X-LY 333-1745X-OR	Hi-Vis Yellow Hi-Vis Orange	X-Back, CSA 296, Black Bottom	Type R Class 3	300 D. Polyester Shell	Zipper	7	2" Two-Tone	S - 5XL

Hi-Vis Multi-Seasonal

333-WBLY 333-WBOR	Hi-Vis Yellow Hi-Vis Orange	Windbreaker with Lightweight Lining	Type R Class 3	Polyester	Snap	2	2" Silver	M - 5XL
333-1500-R	Hi-Vis Yellow / Black	4-in-1 Reversible with Zip-off Sleeves	Type R Class 3	Polyester	Zipper	6	2" Silver	S - 5XL
333-1550-LY	Hi-Vis Yellow / Black	Softshell Grid Fleece, Weatherproof, Black Bottom	Type R Class 3	Rip Stop Polyester / Grid Fleece 3-Layer	Zipper	9	2" Segmented	S - 5XL
3SS7000	Hi-Vis Yellow / Black	Softshell, Black Trim, Weather Resistant	Type P Class 2	Rip Stop Polyester / Grid Fleece 3-Layer	Zipper	3	2" Silver	M-3XL

Hi-Vis Coats

343-1750-LY 343-1750-OR	Hi-Vis Yellow / Black Hi-Vis Orange / Black	Fixed Quilted Insulation, Black Bottom, Tablet Pocket	Type R Class 3	300 D Polyester Shell	Snap	3	2" Silver	S - 5XL
343-1756-LY 343-1756-OR	Hi-Vis Yellow / Black Hi-Vis Orange / Black	7-in-1 Coat, Reversible Class 2 Inner Jacket	Type R Class 3	300 D Polyester Shell	Zipper	12	2" Silver	S - 5XL



Overpants & Gaiters



PANTS



GARMENT



COMPLIANT



Overpants

STYLE NUMBER	HI-VIS COLOR	FEATURE	ANSI 107	FABRIC	CLOSURE	POCKETS	REFLECTIVE	SIZE
318-1757-YEL	Hi-Vis Yellow	Two-Tone Tape	Class E	300 D Polyester Shell	Elastic	2	2" Silver	S - 5XL
318-1757-OR	Hi-Vis Orange							
318-1771-LY	Hi-Vis Yellow	Tear-Resistant, Reinforced Wear Points	Class E	300 D Ripstop Polyester Shell	Drawstring Elastic	5	2" Silver	S - 5XL
318-1771-OR	Hi-Vis Orange							
318-1775-LY	Hi-Vis Yellow	Insulated Bib Overalls with Removable Bib	Class E	300 D Ripstop Polyester Shell	Drawstring Elastic	3	2" Silver	S - 5XL
318-1780-LY	Hi-Vis Yellow	Insulated Bib Overalls with Removable Bib	Class E	150 D Ripstop Polyester Shell	Drawstring Elastic	3	2" Two-Tone	S - 5XL
318-1780-OR	Hi-Vis Orange							
318-1780-BK	Black	Insulated Bib Overalls with Removable Bib	Non-ANSI	150 D Ripstop Polyester Shell	Drawstring Elastic	3	2" Two-Tone	S - 5XL
319-MTPLY	Hi-Vis Yellow	Mesh Traffic Pant	Class E	Mesh	Drawstring Elastic	1	2" Two-Tone	S/M, L/XL, 2X/3X, 4X/5X
3NR4000	Hi-Vis Yellow	Insulated Waterproof Pants with Take-Up Snaps	Class E	300 D Polyester/PU Insulated	Elastic & Drawstring	2	2" Silver	M-3XL

Gaiters

319-GT1-LY	Hi-Vis Yellow	Mesh Lightweight Enhanced Visibility	Class E	Mesh	Hook and Loop	-	2" Silver	ONE SIZE
319-GT1-OR	Hi-Vis Orange							
319-GT2-LY	Hi-Vis Yellow	Mesh Lightweight Enhanced Visibility	Class E	Mesh	Hook and Loop	-	2" Two-Tone	ONE SIZE
319-GT2-OR	Hi-Vis Orange							



SECTION:

Rainwear

This section contains rainwear and splashwear designed to protect workers from liquid splash and contaminations, defend against heavy rain and provide splash protection for pressure washing applications. Products are designed with enhanced features, construction and durability to deliver superior performance in demanding conditions.

Users are advised to conduct their own evaluations to determine the suitability of the protective clothing for each specific application.

Previously worn suits should be inspected daily, especially before being put into use again, to ensure that wear and tear or chemical exposure has not reduced the integrity of the suit. Suits that show wear or have been in intimate contact with the chemicals should be properly disposed of.

STANDARDS

ASTM D6413 – Self Extinguishing

Rainwear and splashwear that provide limited flame resistance.

Requirements

- > Showing no visible flame or glow after 2 seconds and a char length of 6 inches or less after the ignition source is removed.

ASTM F1891/NFPA 70E – ARC Rated

Rainwear that will provide protection against the intense heat and energy generated by an ARC-flash explosion.

Requirements

- > All fire-resistant rain gear to be ARC-rated equal to or greater than 5.0 cal/cm².
- > No dripping is permitted throughout testing at twice the exposure level of the ARC rating.

ANSI 107 – Hi-Visibility

Rainwear and splashwear that provide enhanced visibility for workers who are exposed to traffic and working against complex backgrounds.

ANSI TYPE R

Roadway Use.

ANSI CLASS E

These garments are not compliant when worn alone but, when combined with Class 2 or Class 3 apparel, the combination meets Class 3 requirements



CHEMICAL & LIQUID
SPLASH



STRUCK-BY-
HAZARDS



CONTAMINATION



HEAVY RAIN



Assurance[®]
CHEMICAL PROTECTION

ChemFR[™]

Protection against
incidental contact
with contaminants



Scan it



SELF-EXTINGUISHING - ASTM D6413



205-420B
Bib Overalls



205-420CV
Coveralls



205-420JH
Jacket



POCKETS
2



205-375FR
Jacket



Extra protection

12" x 12" shroud

Attaches to a faceshield to help prevent water from entering the suit

STYLE NUMBER	COLOR	GARMENT	THICKNESS	FABRIC	CLOSURE	POCKETS	SIZE	PROPS
4045	Green	Two-Piece Suit	0.40 mm	PVC / Polyester	Snap	2	M - 4XL	⚠ C&R
205-420B	Green	Bib Overalls	0.42 mm	PVC / Nylon / PVC	Snap & Zipper	0	S - 5XL	⚠ C&R
205-420CV	Green	Coveralls	0.42 mm	PVC / Nylon / PVC	Snap & Zipper	0	S - 5XL	⚠ C&R
205-420JH	Green	Jacket	0.42 mm	PVC / Nylon / PVC	Snap & Zipper	0	S - 5XL	⚠ C&R
205-375FR	Yellow	Jacket	0.35 mm	PVC / Polyester	Hook & Loop and Zipper	2	S - 8XL	⚠ C&R

C = ⚠ **WARNING:** Cancer - www.P65Warnings.ca.gov

R = ⚠ **WARNING:** Reproductive Harm - www.P65Warnings.ca.gov

C&R = ⚠ **WARNING:** Cancer and Reproductive Harm - www.P65Warnings.ca.gov



PIP

Viz™

Light and breathable
rainwear with ANSI 107
compliance for hi-vis



Scan it



STYLE NUMBER	COLOR	GARMENT	ANSI 107	FABRIC	CLOSURE	POCKETS	REFLECTIVE	SIZE
353-1000-LY 353-1000-OR	Hi-Vis Yellow Hi-Vis Orange	Jacket & Pant	Type R Class 3	150 D Polyester / PU	Zipper	2	2" Silver Sewn-On	S/M, L/XL, 2X/3X, 4X/5X
353-1048-LY 353-1048-OR	Hi-Vis Yellow Hi-Vis Orange	48" Long Coat	Type R Class 3	150 D Polyester / PU	Zipper	3	2" Silver Sewn-On	S - 5XL
353-1200LY 353-1200OR	Hi-Vis Yellow/Black Hi-Vis Orange/Black	Jacket	Type R Class 3	150 D Ripstop Polyester / PU	Zipper	3	2" Silver Sewn-On	S/M, L/XL, 2X/3X, 4X/5X
353-1202LY 353-1202OR	Hi-Vis Yellow/Black Hi-Vis Orange/Black	Pants	Class E	150 D Ripstop Polyester / PU	Elastic and Removable Suspenders	2	2" Silver Sewn-On	S/M, L/XL, 2X/3X, 4X/5X
4033	Hi-Vis Yellow	Jacket & Pant	Type R Class 3	300 D Polyester / PU	Snap	2	2" Silver Sewn-On	S - 6XL
WW4033J	Hi-Vis Yellow	Jacket	Type R Class 3	300 D Polyester / PU	Snap	2	2" Silver Sewn-On	S - 5XL
WW4033P	Hi-Vis Yellow	Pants	Class E	300 D Polyester / PU	Snap	0	2" Silver Sewn-On	S - 5XL
4530	Hi-Vis Yellow	Rainsuit	Type R Class 3	300 D Polyester / PU	zipper	6	2" Silver Sewn-On	M - 4XL



VizPLUS™

VizAR™

Designed with enhanced features, construction and durability to deliver ANSI 107 compliant hi-vis, ARC-rated rainwear and superior protection from heavy rain



Scan it



VizPLUS™ offers higher level durable, breathable and waterproof engineered fabrics

VizAR™ features durable and waterproof ARC-rated protection that is ANSI 107 compliant for hi-vis

VizPLUS™

STYLE NUMBER	COLOR	GARMENT	ANSI 107	FABRIC	CLOSURE	POCKETS	REFLECTIVE	SIZE
353-2000-LY 353-2000-OR	Hi-Vis Yellow Hi-Vis Orange	Jacket	Type R Class 3	300 D Polyester / PU	Zipper	5	2" Silver Sewn-On	S - 5XL
353-2001-LY 353-2001-OR	Hi-Vis Yellow Hi-Vis Orange	Bib Overalls	Class E	300 D Polyester / PU	Suspenders & Snap	1	2" Silver Sewn-On	S - 5XL
353-2002-LY 353-2002-OR	Hi-Vis Yellow Hi-Vis Orange	Pants	Class E	300 D Polyester / PU	Elastic & Drawstring	2	2" Silver Sewn-On	S - 5XL
4530SE	Hi-Vis Yellow	Rainsuit	Type R Class 3	SE 300 D. Polyester/PU	Hook & Loop and Zipper	6	2" Silver Sewn-On	M - 4XL
4540B	Hi-Vis Yellow	Bib Overalls	-	Stretch Polyurethane	Snap	4	No Tape	M - 4XL
4540J	Hi-Vis Yellow	Jacket	-	Stretch Polyurethane	Hook & Loop and Zipper	2	No Tape	M - 4XL
4540P	Hi-Vis Yellow	Pants	-	Stretch Polyurethane	Elastic	2	No Tape	M - 4XL
4541J	Hi-Vis Yellow	Jacket	Type R Class 3	Stretch Polyurethane	Hook & Loop and Zipper	2	2" Segmented Heat Applied	M - 4XL
4541P	Hi-Vis Yellow	Pants	Class E	Stretch Polyurethane	Snap	3	2" Segmented Heat Applied	M - 4XL

VizAR™ (ARC Rating: ATPV 16.2 cal/cm²)

355-2500AR	Hi-Vis Yellow	Jacket	Type R Class 3	0.75 mm FR PU / Cotton	FR Hook & Loop and Zipper	2	2" FR Silver Heat Applied	S - 5XL
355-2501AR	Hi-Vis Yellow	Bib Overalls	Class E	0.75 mm FR PU / Cotton	FR Hook and Loop	2	2" FR Silver Heat Applied	S - 5XL
355-2505AR	Hi-Vis Yellow	48" Coat	Type R Class 3	0.75 mm FR PU / Cotton	FR Hook & Loop and Zipper	2	2" FR Silver Heat Applied	S - 5XL





FLEX™

Featuring a unique design that enables ease of movement while providing durable and tough rain protection



Scan it





201-650B
Bib Overalls



201-650C
48" Coat



201-650J
Jacket

POCKETS
3

The FLEX™ brushed, non-woven lining provides comfort while the welded seams ensure maximum durability and longstanding wear

STYLE NUMBER	COLOR	GARMENT	THICKNESS	FABRIC	CLOSURE	POCKETS	SIZE	PROP 65
201-650B	Yellow	Bib Overalls	0.65 mm	Embossed PVC/Brushed Polyester	Snap	0	S-5XL	⚠️ C&R
201-650C	Yellow	48" Coat	0.65 mm	Embossed PVC/Brushed Polyester	Snap	2	S-5XL	⚠️ C&R
201-650J	Yellow	Jacket	0.65 mm	Embossed PVC/Brushed Polyester	Snap	2	S-5XL	⚠️ C&R

C = ⚠️ WARNING: Cancer - www.P65Warnings.ca.gov

R = ⚠️ WARNING: Reproductive Harm - www.P65Warnings.ca.gov

C&R = ⚠️ WARNING: Cancer and Reproductive Harm - www.P65Warnings.ca.gov



BASE™

BASE™ rainwear by Boss® has a special PVC outer layered material that provides protection against rain, liquid splash and incidental contact



Scan it



BASE50

STYLE NUMBER	COLOR	GARMENT	THICKNESS	FABRIC	CLOSURE	POCKETS	REFLECTIVE	SIZE	PROPS
3PRO500G	Green	Jacket	0.50mm	PVC / Polyester	Zipper	2	-	M-5XL	⚠️ C&R
3PRO500Y	Yellow	Jacket	0.50mm	PVC / Polyester	Zipper	2	-	M-5XL	⚠️ C&R
3PRO501G	Green	Bib Overalls	0.50mm	PVC / Polyester	Snap	0	-	M-5XL	⚠️ C&R
3PRO501Y	Yellow	Bib Overalls	0.50mm	PVC / Polyester	Snap	0	-	M-5XL	⚠️ C&R

BASE35

4031	Hi-Vis Lime	Jacket & Bib Overalls	0.35 mm	PVC / Polyester	Snap	2	1" Silver	M - 5XL	⚠️ C&R
4338	Yellow	Jacket & Bib Overalls	0.35 mm	PVC / Polyester	Zipper	4	1" Silver	M-4XL	⚠️ C&R
4035	Yellow	Jacket & Bib Overalls	0.35 mm	PVC / Polyester	Snap	2	-	S - 8XL	⚠️ C&R
201-355	Hi-Vis Lime	Jacket & Bib Overalls	0.35 mm	PVC / Polyester	Snap	2	-	S - 5XL	⚠️ C&R
201-360	Hi-Vis Orange	Jacket & Bib Overalls	0.35 mm	PVC / Polyester	Snap	2	-	S - 5XL	⚠️ C&R
201-370	Yellow	Jacket & Bib Overalls	0.35 mm	PVC / Polyester	Snap	2	-	S - 5XL	⚠️ C&R
3PRO300C	Camo	Jacket & Bib Overalls	0.35 mm	PVC / Polyester	Snap	2	-	M-3XL	⚠️ C&R
3PRO300G	Green	Jacket & Bib Overalls	0.35 mm	PVC / Polyester	Snap	2	-	S-3XL	⚠️ C&R
3PRO300Y	Yellow	Jacket & Bib Overalls	0.35 mm	PVC / Polyester	Snap	2	-	S-6XL	⚠️ C&R
4036	Yellow	Jacket	0.35 mm	PVC / Polyester	Snap	2	-	S - 5XL	⚠️ C&R
201-350B	Yellow	Bib Overalls	0.35 mm	PVC / Polyester	Snap	0	-	S - 5XL	⚠️ C&R
201-350P	Yellow	Pants	0.35 mm	PVC / Polyester	Snap	0	-	S - 5XL	⚠️ C&R
4148	Yellow	48" Coat	0.35 mm	PVC / Polyester	Snap	2	-	S - 5XL	⚠️ C&R
201-320	Yellow	60" Duster	0.35 mm	PVC / Polyester	Snap	2	-	M - 7XL	⚠️ C&R
201-322	Black	60" Duster	0.35 mm	PVC / Polyester	Snap	2	-	M - 7XL	⚠️ C&R



4031
Jacket & Bib Overalls

C = ⚠️ WARNING: Cancer - www.P65Warnings.ca.gov

R = ⚠️ WARNING: Reproductive Harm - www.P65Warnings.ca.gov

C&R = ⚠️ WARNING: Cancer and Reproductive Harm - www.P65Warnings.ca.gov



Base35FR™ (SELF-EXTINGUISHING / ASTM D6413)

STYLE NUMBER	COLOR	GARMENT	THICKNESS	FABRIC	CLOSURE	POCKETS	REFLECTIVE	SIZE	PROP 65
205-300FR	Yellow	48" Coat	0.35 mm	PVC / Polyester	Snap	2	-	S - 5XL	⚠ C&R
205-320FR	Yellow	60" Duster	0.35 mm	PVC / Polyester	Snap	2	-	S - 7XL	⚠ C&R
4160BFR	Black	60" Duster	0.35 mm	PVC / Polyester	Snap	2	-	M - 4XL	⚠ C&R
4035FR	Yellow	3 Piece Rainsuit	0.35 mm	PVC / Polyester	Snap	2	-	S - 8XL	⚠ C&R
BASE25									
201-250	Yellow	Jacket & Bib Overalls	0.25 mm	PVC	Snap	2	-	S - 5XL	⚠ C&R
BASE10									
201-100	Yellow	Jacket & Bib Overalls	0.10 mm	PVC	Snap	2	-	S - 5XL	⚠ C&R
49102/Y	Yellow	Poncho	0.10 mm	PVC	Snap	0	-	OS	⚠ C&R
49102/O	Orange	Poncho	0.10 mm	PVC	Snap	0	-	OS	⚠ C&R
60	Green	Poncho	0.10 mm	PVC	Snap	0	-	OS	⚠ C&R
61	Clear	Poncho	0.10 mm	PVC	Snap	0	-	OS	⚠ C&R
62	Blue	Poncho	0.10 mm	PVC	Snap	0	-	OS	⚠ C&R
PE 4									
42	Clear	Poncho	0.4mm	Polyethylene	Snap	0	-	OS	-
43	Yellow	Poncho	0.4mm	Polyethylene	Snap	0	-	OS	-

C=⚠ **WARNING:** Cancer - www.P65Warnings.ca.gov

R=⚠ **WARNING:** Reproductive Harm - www.P65Warnings.ca.gov

C&R=⚠ **WARNING:** Cancer and Reproductive Harm - www.P65Warnings.ca.gov



4160BFR
60" Duster



BASE LAYER
HEATED VEST



Heated Vest

The BOSS® THERM HEATED VEST is an ideal base layer designed to be worn over a shirt or any thermal garment

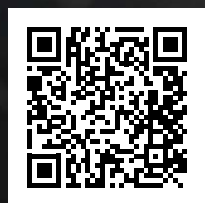

Scan it



Revolutionary heating technology at the press of a button

- Utilizes innovative flexible heating panels built into the chest and back
- Three individual temperature settings - low, medium, and high range



Powerful 5-volt rechargeable power bank with an integrated USB plug in cord



Includes a convenient remote control allowing the wearer to quickly adjust the temperature settings and continue working without removing clothing layers

STYLE NUMBER	MATERIAL	BATTERY	COLOR	SIZE
300-HV100	Nylon	5V, Rechargeable	Black	OS

300-HV100

SECTION:

Aprons and Sleeves

This section features protective aprons and sleeves. PIP® offers a wide variety of aprons, ranging from disposable polymer aprons that help protect against wetness, splash and soiling to fabric aprons that offer protection from abrasion and even Aramid aprons that help prevent dangerous cuts.

Vinyl sleeves – unlike knitted cut resistant sleeves – provide extended wetness and contamination protection to forearms.

PRODUCTS

PVC / Vinyl Aprons and Smocks provide excellent resistance to punctures and abrasion while protecting the worker from fats, oils, grease as well as a wide variety of chemicals. Many of PIP's PVC and vinyl aprons are compliant with the Federal Regulations for food contact, 21-CFR 170-199, which refers to any raw materials that that may come in contact with food indirectly when packaging, holding or processing.

Denim Aprons are composed of 100% durable cotton fabric that provides excellent barrier protection against dirt, dust and grime.

Neoprene Aprons provide superior protection from a wide range of chemicals, such as acids, caustics, solvents and oils.

Cut Resistant Aprons are utilized in a variety of industrial operations, including glass and metal fabrication, assembly and automotive manufacturing. This is due to their exceptional resistance to cut and abrasion. PIP's ANSI rated cut-resistant aprons deliver reliable protection, comfort and durability.

Vinyl Sleeves provide complete forearm coverage, protecting against dry, wet and oily hazards. All PIP® vinyl sleeves are compliant with the Federal Regulations 21 CFR 179-199 for food contact.



FOOD
CONTAMINATION



CUTS AND SNAGS



PUNCTURES AND
ABRASION



CHEMICALS



LIQUID SPRAYS AND
SPLASHES



FATS, OILS AND
GREASE



DIRT & DEBRIS



Scan it



Aprons, Smocks and Reusable Sleeves

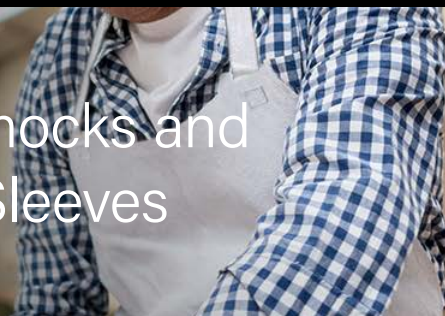

ANSI
A2

30-BCM24342G
Cut Resistant Apron



ANSI
A2

10-KAD2424W/BUCKLE
Cut Resistant Apron



POCKETS
2

200-012 / Denim Apron



POCKETS
3

A2836D5 / Denim Apron



200-07501 / Vinyl Apron



UC-12 / Vinyl Apron



UUB / Vinyl Apron



200-12501 / Neoprene Apron

Vinyl Aprons/Smocks

STYLE NUMBER	Z1 CFR	MATERIAL	COLOR	TYPE	WEIGHT	DIMENSIONS	POCKETS	PROP 65
200-07501	Yes	Vinyl	White	Reusable	8 mil	35" x 45"	-	⚠ C&R
200-08001	Yes	Vinyl	White	Reusable	8 mil	35" x 45"	-	⚠ C&R
200-20001	Yes	Vinyl	White	Reusable	20 mil	35" x 45"	-	⚠ C&R
UC-12	Yes	Vinyl	Clear	Reusable	12 mil	35" x 45", 35" x 50"	-	⚠ C&R
UE4B	Yes	Vinyl	Blue	Reusable	4 mil	27" x 45"	-	⚠ C&R
UE6B	Yes	Vinyl	Blue	Reusable	6 mil	35" x 45", 35" x 50", 35" x 55"	-	⚠ C&R
UE6W	Yes	Vinyl	White	Reusable	6 mil	35" x 50"	-	⚠ C&R
UG-20	No	Vinyl	Green	Reusable	20 mil	35" x 45", 35" x 48"	-	⚠ C&R
UG-20-SP	No	Vinyl	Green	Reusable	20 mil	35" x 45"	-	⚠ C&R
UHB	Yes	Vinyl	Blue	Reusable	6 mil	35" x 48", 35" x 55"	-	⚠ C&R
UPB	No	Vinyl	Blue	Reusable	8 mil	35" x 45", 35" x 48", 35" x 55"	-	⚠ C&R
UPC	No	Vinyl	Clear	Reusable	8 mil	35" x 45", 35" x 36"	-	⚠ C&R
UPW	No	Vinyl	White	Reusable	8 mil	35" x 45", 35" x 48"	-	⚠ C&R
UUB	Yes	Vinyl	Blue	Reusable	6 mil	35" x 45", 35" x 48", 35" x 50"	-	⚠ C&R
UUPB	No	Vinyl	Blue	Reusable	8 mil	35" x 45"	-	⚠ C&R
UUV	No	Vinyl	White	Reusable	6 mil	35" x 45"	-	⚠ C&R

C = ⚠ WARNING: Cancer - www.P65Warnings.ca.gov

R = ⚠ WARNING: Reproductive Harm - www.P65Warnings.ca.gov

C&R = ⚠ WARNING: Cancer and Reproductive Harm - www.P65Warnings.ca.gov

Denim Aprons

STYLE NUMBER	Z1 CFR	MATERIAL	COLOR	TYPE	WEIGHT	DIMENSIONS	POCKETS	PROP 65
200-011	No	Denim	Blue	Reusable	10oz	28" x 38"	0	-
200-011	No	Denim	Blue	Reusable	10oz	28" x 38"	1	-
200-012	No	Denim	Blue	Reusable	10oz	28" x 38"	2	-
A2412D3	No	Denim	Blue	Reusable	12oz	12" x 24"	3	-
A2836D2	No	Denim	Blue	Reusable	12oz	28" x 36"	2	-
A2836D3BT	No	Denim	Blue	Reusable	12oz	28" x 36"	1	-
A2836D4BDT	No	Denim	Blue	Reusable	16oz	28" x 36"	2	-
A2836D5	No	Denim	Blue	Reusable	12oz	28" x 36"	3	-
A2836D62BT	No	Denim	Blue	Reusable	12oz	28" x 36"	3	-
A2842D4	No	Denim	Blue	Reusable	12oz	28" x 42"	2	-

Neoprene Apron

200-12501	No	Neoprene	Black	Reusable	20 mil	35" x 45"	-	-
-----------	----	----------	-------	----------	--------	-----------	---	---

Cut Resistant Aprons

10-KAD2424W/BUCKLE	Yes	Kevlar Twill 2 Ply	Yellow	Reusable	-	24" x 24"	-	-
30-BCM24342G	Yes	Nylon Cane Mesh 2 Ply	Black	Reusable	-	24" x 34"	-	-

Vinyl Sleeves

UVB-4HS	Yes	Vinyl	Blue	Reusable	4 mil	18"	-	⚠ C&R
UVB-8HS	Yes	Vinyl	Blue	Reusable	8 mil	18"	-	⚠ C&R
UVC-4HS	Yes	Vinyl	Clear	Reusable	4 mil	18"	-	⚠ C&R
UVC-8HS	Yes	Vinyl	Clear	Reusable	8 mil	18"	-	⚠ C&R

SECTION:

ARC Flash and Flame Resistant Protection



This section contains important PPE related to ARC flash and flame-resistant protection. Electrical workers face the risk of hazards when carrying out their work. That is why it is important for them to wear the appropriate Personal Protective Equipment (PPE) to reduce the risk they are exposed to. PPE worn needs to ensure that the hazard is minimized, while also allowing them to do their job. Whether you are an electrical or utility worker, working on an oil rig or working in a metal or glass foundry, PIP® offers a full line of safety garments that meet and exceed tough ANSI and NFPA standards.

ARC AND FLAME RESISTANCE

ARC RATED (AR)

ARC Rated (AR) garments help to provide flame and thermal protection from exposure to an electrical ARC flash. AR garments are designed and treated to help limit exposure and burn percentage as a result of an electrical ARC flash incident. There are many variables to consider when selecting AR protective clothing. Most importantly, the employer must perform a Hazard Risk Analysis for the workplace to identify risks and set the appropriate boundaries. The results of this analysis will then guide the employer to the level of protection needed.

The National Fire Protection Association (NFPA) uses four ARC flash PPE Categories to classify ranges of ARC flash hazards, and the corresponding requirements for Personal Protective Equipment (PPE). The categories are one method used in the current NFPA 70E standard to inform workers about the protection they need while working on energized equipment.

Each category includes a minimum ARC Rating (AR) value for the required garment. This value indicates the amount of heat energy (in cal/cm²) that the clothing can absorb or block before the wearer would be likely to receive a second-degree burn. (Second-degree burns are expected when skin is exposed to 1.2 cal/cm² of incident energy.)

PPE Category 1 and 2 requirements are typically met with single-layer ARC/FR garments and lighter head and face gear. To meet higher risk hazard levels such as PPE Category 3 or 4, multi-layer garments and headgear with more coverage is required. *See page 282 for more details. IMPORTANT: All AR garments are flame-resistant, however not all FR garments are rated for ARC flash protection.*

FLAME RESISTANT (FR)

Flame resistant garments earn their designation because they are made of fabrics that are inherently resistant to or are treated to be resistant to igniting when exposed directly to flame. The material resists ignition and/or will self-extinguish when ignited, and will not melt. FR garments also create a thermal barrier to help protect the wearer's skin when exposed to direct heat energy and may minimize the amount of second- and third-degree burns incurred. FR fabrics include:

- > Modacrylics, Aramids and Para-aramids are among the inherently flame-resistant fabrics. They do not lose those characteristics through wear or laundering.
- > Treated Fabrics such as cotton and cotton blends require FR treatment to achieve self-extinguishing properties. This treatment will eventually fade with washing. However, if the garment is properly cared for, the treatment can last the life of the garment. FR treated cotton and cotton blends provide a more comfortable and affordable solution.



VISIBILITY



MOLTEN
METALS



ARC FLASH



FLASH FIRE



Scan it

PIP ARC Rated Clothing

Next-to-skin
comfort &
breathability



385-FRLS
Long Sleeve T-Shirt



385-FRHN
Long Sleeve Henley



385-FRSS
Short Sleeve Shirt



385-FRPH
Pullover Hoodie



385-FRZH
Zipper Hoodie



305-3200
Solid vest



305-2100
Mesh vest



ARC Rated Flame Resistant Shirts (short sleeve t-shirts should be worn as an undergarment only)

STYLE NUMBER	COLOR	GARMENT	PPE CATEGORY	ARC RATING	MATERIAL	WEIGHT	POCKETS	STANDARD	CLOSURE	SIZE
385-FRLS-NV	Navy	Long Sleeve T-Shirt	2	11.8 cal/cm ²	100% Cotton	6.5oz	1	NFPA 70E, ASTM F1506	Pullover	M - 4XL
385-FRLS-OR	Orange	Long Sleeve T-Shirt	2	11.8 cal/cm ²	100% Cotton	6.5oz	1	NFPA 70E, ASTM F1506	Pullover	M - 4XL
385-FRLS-LG	Light Gray	Long Sleeve T-Shirt	2	11.8 cal/cm ²	100% Cotton	6.5oz	1	NFPA 70E, ASTM F1506	Pullover	M - 4XL
385-FRLS-GR	Gray	Long Sleeve T-Shirt	2	11.8 cal/cm ²	100% Cotton	6.5oz	1	NFPA 70E, ASTM F1506	Pullover	M - 4XL
385-FRHN-NV	Navy	Long Sleeve Henley	2	11.8 cal/cm ²	100% Cotton	6.5oz	1	NFPA 70E, ASTM F1506	Pullover	M - 3X
385-FRHN-OR	Orange	Long Sleeve Henley	2	11.8 cal/cm ²	100% Cotton	6.5oz	1	NFPA 70E, ASTM F1506	Pullover	M - 3X
385-FRHN-LG	Light Gray	Long Sleeve Henley	2	11.8 cal/cm ²	100% Cotton	6.5oz	1	NFPA 70E, ASTM F1506	Pullover	M - 3X
385-FRSS-NV	Navy	Short Sleeve Shirt	2	11.8 cal/cm ²	100% Cotton	6.5oz	1	NFPA 70E, ASTM F1506	Pullover	M - 3X
385-FRSS-LG	Light Gray	Short Sleeve Shirt	2	11.8 cal/cm ²	100% Cotton	6.5oz	1	NFPA 70E, ASTM F1506	Pullover	M - 3X

ARC Rated Flame Resistant Sweatshirts

385-FRPH-NV	Navy	Hoodie	2	20 cal/cm ²	100% Cotton	12 oz. Fleece Knit	1	NFPA 70E, ASTM F1506	Pullover	M - 3XL
385-FRPH-OR	Orange	Hoodie	2	20 cal/cm ²	100% Cotton	12 oz. Fleece Knit	1	NFPA 70E, ASTM F1506	Pullover	M - 3XL
385-FRZH-NV	Navy	Hoodie	2	20 cal/cm ²	100% Cotton	12 oz. Fleece Knit	2	NFPA 70E, ASTM F1506	Zipper	M - 3XL
385-FRZH-OR	Orange	Hoodie	2	20 cal/cm ²	100% Cotton	12 oz. Fleece Knit	2	NFPA 70E, ASTM F1506	Zipper	M - 3XL



Dual Certified Clothing



315-1350FR
Long Sleeve T-Shirt



385-1370FR
Hoodie



Dual certified means the garment and material have been tested and certified by a third party and indicates compliance with two standards:

NFPA 70E:
Standard for electrical safety in the workplace

NFPA 2112:
Standard for protection against flash fire

385-FRWS
Shirt



385-FRCJ
Carpenter jeans

385-FRWS
Shirt



385-FRRJ
Regular jeans

Hi-Vis Apparel

STYLE NUMBER	COLOR	ANSI 107	GARMENT	PPE CATEGORY	ARC RATING	MATERIAL	WEIGHT	POCKETS	STANDARD	CLOSURE	REFLECTIVE	SIZE
305-2100	Hi-Vis Yellow	Type R Class 2	Vest	1	5.1 cal/cm ²	Modacrylic	6.2 oz. Mesh	1	ANSI 107, NFPA 70E, ASTM F1506	Hook and Loop	2" Silver	M - 5XL
305-2200	Hi-Vis Yellow	Type R Class 2	Vest	2	8.9 cal/cm ²	Westex	6.2 oz Solid	0	ANSI 107, NFPA 70E, ASTM F1506	Hook and Loop	2" Silver	M - 5XL
305-3100	Hi-Vis Yellow	Type R Class 3	Vest	1	5.1 cal/cm ²	Modacrylic	6.2 oz Mesh	1	ANSI 107, NFPA 70E, ASTM F1506	Hook and Loop	2" Silver	M - 5XL
305-3200	Hi-Vis Yellow	Type R Class 3	Vest	2	8.9 cal/cm ²	Westex	6.5 oz Solid	0	ANSI 107, NFPA 70E, ASTM F1506	Hook and Loop	2" Silver	M - 5XL
385-1370FR	Hi-Vis Lime Yellow/Black	-	Hoodie	2	19 cal/cm ²	Modacrylic / FR Cotton	12 oz. Fleece Knit	3	ANSI 107 Type R Class 3, NFPA 70E, ASTM F1506	Zipper	2" FR Segmented Heat Applied	S - 5XL
315-1350FR	Hi-Vis Yellow	-	Long Sleeve T-Shirt	2	8.6 cal/cm ²	100% Cotton	--	0	NFPA 70E, ASTM F1506	Pullover	2" Silver	M - 5XL

Dual Certified Clothing

385-FRWS-KH	Tan	-	Flame Resistant Shirt	2	8.5 cal/cm ²	Cotton/Nylon	7oz	2	NFPA 70E, ASTM F1506 & NFPA 2112-2012	Buttons	-	M - 4XL
385-FRWS-NV	Navy	-	Flame Resistant Shirt	2	8.5 cal/cm ²	Cotton/Nylon	7oz	2	NFPA 70E, ASTM F1506 & NFPA 2112-2012	Buttons	-	M - 4XL
385-FRRJ	Denim	-	Flame Resistant Jeans	2	16 cal/cm ²	Cotton/Twill/Denim	13oz	5	NFPA 70E, ASTM F1506 & NFPA 2112-2012	Zipper	-	30-50W x 30-36L
385-FRCJ	Denim	-	Flame Resistant Jeans	2	16 cal/cm ²	Cotton/Twill/Denim	13oz	6	NFPA 70E, ASTM F1506 & NFPA 2112-2012	Zipper	-	30-50W x 30-36L

Vests to be worn over ARC rated FR clothing only



ARC Rated Clothing



9100-2170D
Coveralls



9100-52564
Overalls



9100-21782
Jacket



9100-22070
Overpants



ARC Rated Flame Resistant Dual Certified Coveralls

STYLE NUMBER	COLOR	FEATURE	PPE CAT.	ARC RATING	MATERIAL	WEIGHT	POCKETS	STANDARD	CLOSURE	SIZE
385-FRSC-NV 385-FRSC-KH	Navy Khaki	Multiple Pockets	2	8 cal/cm ²	90% Cotton 10% Nylon	7 oz. Woven FR Fabric	8	NFPA 70E, ASTM F1506 & NFPA 2112-2012	Zipper	S - 5XL
9100-2100D	Tan	Action Back for Mobility	2	8 cal/cm ²	90% Cotton 10% Nylon	7 oz. Woven FR Fabric	2	NFPA 70E, ASTM F1506 & NFPA 2112-2012	Hook and Loop	S - 5XL
9100-2110D	Tan	Vented Back for Breathability	2	8 cal/cm ²	90% Cotton 10% Nylon	7 oz. Woven FR Fabric	2	NFPA 70E, ASTM F1506 & NFPA 2112-2012	Hook and Loop	S - 5XL
9100-2120D	Royal Blue	Vented Back for Breathability	2	8 cal/cm ²	90% Cotton 10% Nylon	7 oz. Woven FR Fabric	2	NFPA 70E, ASTM F1506 & NFPA 2112-2012	Hook and Loop	S - 5XL
9100-2160D	Navy	Built-In Insect Repellent	2	8 cal/cm ²	90% Cotton 10% Nylon	7 oz. Woven FR Fabric	2	NFPA 70E, ASTM F1506 & NFPA 2112-2012	Hook and Loop	S - 5XL
9100-2170D	Navy	Action Back for Mobility	2	12 cal/cm ²	90% Cotton 10% Nylon	9 oz. Woven FR Fabric	2	NFPA 70E, ASTM F1506 & NFPA 2112-2012	Hook and Loop	S - 5XL

SECTION:

Disposable Clothing



PROTECTION. PERFORMANCE. VALUE.™

This section outlines PIP's diverse disposable clothing offering that's designed to protect workers from numerous industrial hazards. The material composition of these products is blended from specialized polymers that allow for workers to easily select the correct PPE based on their required level of protection.

PIP® offers a complete line of disposable clothing that meet or exceed the most rigorous NFPA and ASTM testing methods.

STANDARDS

NFPA 99 - Anti-Static

NFPA 99 specifies that materials should have a resistivity of $1 \times 10^{11} \Omega/\text{sq}$ at 50% relative humidity and a static decay time of fewer than 0.5 seconds when measured to the 10% (500 volts) cutoff level.

NFPA 701 - Flame Propagation

The NFPA 701 method requires material test samples to have a char length of less than 6.5", an after-flame of less than 2 seconds and does not BEL (Burn Entire Length) after reaching the floor of the test chamber.

ASTM 1670 - Blood Penetration Resistance

This method is used to evaluate the resistance of materials to penetration from continuous liquid contact. Protective clothing passes or fails based on the visual detection of synthetic blood penetration.

ASTM 1671 - Viral and Blood-Borne Pathogens

Material resistance to the penetration of pathogens is tested by using a surrogate microbe under continuous liquid contact. PPE will pass or fail based on the detection of viral penetration using the single-stranded DNA virus Phi-X174 bacteriophage.

ASTM F739 / F903 - Permeation of Chemicals and Liquids

This method evaluates the barrier effectiveness of PPE materials, seams and closures against liquid penetration from continuous contact. All tested chemicals entail different durations of exposure and hydrostatic pressure, as diverse molecular properties may lead to different results.



CHEMICAL EXPOSURE



DRY PARTICULATES



STATIC BUILDUP



HAZARDOUS MATERIALS



LIQUID SPRAYS AND SPLASHES



VIRAL AND BLOODBORNE PATHOGENS



DIRT & DEBRIS



FINDING THE RIGHT PROTECTION

PRODUCT	DRY PARTICULATE	LIQUID SPRAY & LIGHT SPLASH	CHEMICAL BARRIER	FLAME RESISTANT
Posiwear® Flame Resistant™	▪	▪		▪
Posiwear® Ultimate Barrier™	▪	▪	▪	
Posiwear® Breathable Advantage™	▪	▪		
Posiwear® M3™	▪	▪		

Applications

DRY PARTICULATE LIQUID SPRAY

- ASBESTOS REMOVAL
- DRY/HAZARDOUS CHEMICALS
- CLEANROOM ENVIRONMENT
- GENERAL CLEANUP
- FOOD INDUSTRIES
- MAINTENANCE
- LABORATORIES
- NUCLEAR/RADIOACTIVE EQUIPMENT
- PAINT AND PAINT SPRAY
- WASTE RECYCLING/COLLECTION
- HAZARDOUS MATERIAL REMEDIATION
- FOUNDRIES METALWORKING
- CONSTRUCTION/BUILDING
- UTILITIES (WATER, GAS, ELECTRIC)
- MINING

LIQUID SPLASH

- ACID HANDLING
- BIO-HAZARD EXPOSURE
- CHEMICAL: MID RANGE/LIGHT RANGE
- CHEMICAL: INCREASED HAZARD/SPLASH
- CONSTRUCTION/BUILDING
- FLAMMABLE MATERIALS
- FOUNDRIES/METALWORKING/MINING
- HAZMAT RESPONSE
- HAZARDOUS MATERIAL REMEDIATION
- LABORATORIES
- MAINTENANCE
- PCB REMEDIATION
- REFINERIES - PETROCHEMICAL
- WARFARE AGENTS/CHEMICAL MATERIALS
- TANK CLEANING/MAINTENANCE



Scan it

Flame Resistant Coveralls

MATERIAL COMPOSITION

Provia® is made of a uniquely-treated cellulose/polyester spunlace material. It does not melt, instead it ashes when burned. It is also self-extinguishing. It is extremely soft, durable and breathable.

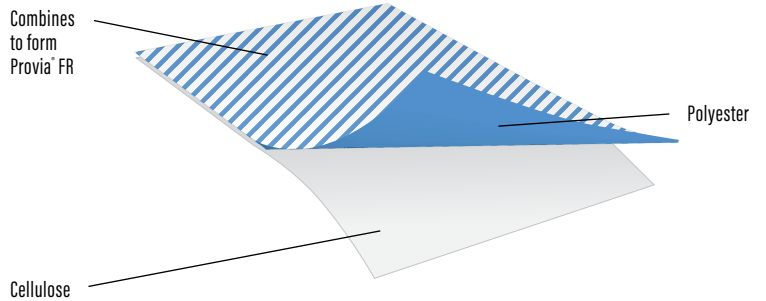

POSIWEAR® FLAME RESISTANT™ TYPICAL PROPERTIES

PHYSICAL PROPERTY	TEST METHODS	UNITS	POSIWEAR® FR
Weight	ASTM D3776	osy	2.39
MD Tensile (Grab)	ASTM D5034	lb/in	27.1
CD Tensile (Grab)	ASTM D5034	lb/in	16.1
MD Tear Strength (Trapezoid)	ASTM D5733	lb/in	7.3
CD Tear Strength (Trapezoid)	ASTM D5733	lb/in	12
Hydrostatic Head	AATCC127	cm	25+
Oil Repellency	AATCC118	holdout rating	5
Static Decay	IST 40.2-95	sec	0.01
Vertical Flame	NFPA 701	% wt loss	20

Posiwear® Flame Resistant™ Coveralls

STYLE NUMBER	GARMENT	CONFIGURATION	CLOSURE	MATERIAL	SEAM TYPE	COLOR	SIZE	PACKAGING
3100	Coverall	Zippered Front	Zipper	Spunlace Polyester / Cellulose Composite	Serged	Blue	M-5XL	25 / case
3106	Coverall	Elastic Wrists and Ankles with Hood	Zipper	Spunlace Polyester / Cellulose Composite	Serged	Blue	M-5XL	25 / case
3109	Coverall	Elastic Wrists, Hood and Boots	Zipper	Spunlace Polyester / Cellulose Composite	Serged	Blue	M-5XL	25 / case

3100

- Self-extinguishes when sparks are present
- Protects the integrity of worker's underlying suit
- Good particulate and liquid splash protection
- NFPA 701 / NFPA 99 Anti-static
- Wicks moisture from the body
- Repellent to oil, water and alcohol
- Serged seams



Ultimate Barrier™

Scan it

Chemical / Petrochemical Industry / Cleaning and Industrial Maintenance / Hazardous Material Transport / Industrial Painting / Emergency Services / Pharmaceutical Industry / Oil Handling / Waste Management / Remediation

MATERIAL COMPOSITION

The Polysafe® material in our white suits is made of a strong two-layer composite fabric of resistant and durable polypropylene fabric and PE film. At 58 gsm, they are softer and more drapable.

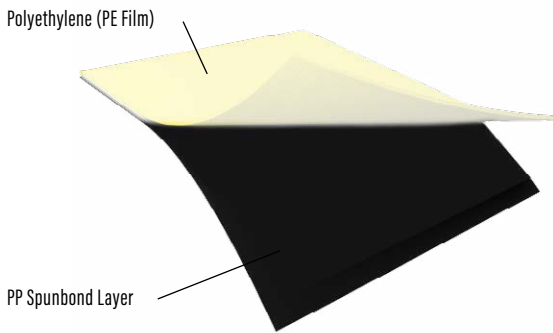

The Polysafe® material in our yellow suits are made of a strong, three-layer extrusion-coated fabric of resistant and durable polypropylene fabric and PE film. At 82 gsm, they are heavier and stronger.

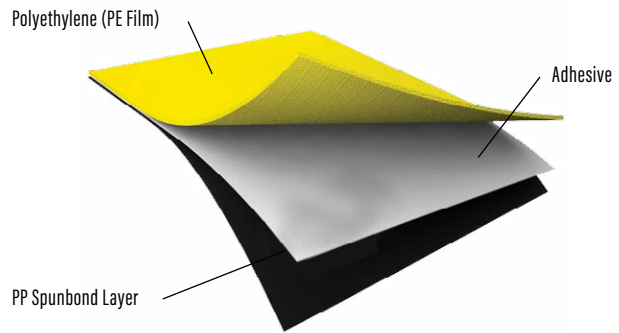

Posiwear® Ultimate Barrier™ Typical Properties

TECHNICAL PROPERTIES	TEST METHODS	UNITS	WHITE
Strength			
Basis Weight	ASTM D3376	GSM	5763/17oz/yd ²
Grab Tensile Strength	ASTM D5034	Lb/in-MD	29.2
		Lb/in-CD	24.6
Elongation	ASTM D5034	% MD	54.6
		% CD	70.1
Trap Tear	ASTM D5733	Lb/in-MD	12.4
		Lb/in-CD	10.8
Mullen Burst	ASTM D3786-87	psi	34.8
Barrier			
Hydrostatic Head	AATCC 127	cm	>>100
Static Decay	NFPA 99	< 0.5 sec	PASS
Resistance to Blood Penetration	ASTM F1670	Procedure B	PASS
Resistance to Viral Penetration	ASTM F1671	Procedure B	PASS
Comfort			
MVTR (50%RH@90°F)	ASTM E96	Grams/24m ²	65
Linting	Helmke/Drum IES-PP-CC-0032	Particles/min (> 0.5um)	585

*These physical properties represent typical values of the non-woven fabric. These values should not be considered as a specification or certificate of material and/or specification value.

Chemical Penetration Data Summary for Posiwear® ASTM F903, Procedure C

CHEMICAL	CHEMICAL FAMILY	PHYSICAL PHASE	PASS/FAIL
Acetone	Ketone	Liquid	Pass
Acetonitrile	Nitrile	Liquid	Pass
Carbon Disulfide	Sulfur Compound	Liquid	Pass
Dichloromethane	Halogen Compound	Liquid	Pass
Diethylamine	Amine	Liquid	Pass
N,N-Dimethylformamide	Amide	Liquid	Pass
Ethyl Acetate	Ester, Carboxylic	Liquid	Pass
n-Hexane	Hydrocarbon	Liquid	Pass
Methanol	Hydroxylic Compound	Liquid	Pass
Nitrobenzene	Nitro Compound	Liquid	Pass
Sodium Hydroxide	Inorganic Base	Liquid	Pass
Sulfuric Acid	Inorganic Acid	Liquid	Pass
Tetrachloroethylene	Halogen Compound	Liquid	Pass
Tetrahydrofuran	Ether	Liquid	Pass
Toluene	Hydrocarbon	Liquid	Pass

Chemical Penetration test performed by a third party laboratory.
All chemicals used > 95% concentration except for Sodium Hydroxide (50% in water).

CHEMICAL	CHEMICAL FAMILY	PHYSICAL PHASE	AVERAGE NORMALIZED BREAKTHROUGHTIME (minutes)	AVERAGE PERMEATION RATE (ug/cm ² /min.)
Acetone	Ketone	Liquid	8	0.62
Acetonitrile	Nitrile	Liquid	<4	8.7
Ammonia	Inorganic Gas	Gas	4	4.5
1,3 Butadiene	Hydrocarbon	Gas	8	11.9
Carbon Disulfide	Sulfur Compound	Liquid	<4	<50
Chlorine Gas	Element	Gas	6	23
Dichloromethane	Halogen Gas	Liquid	4	0.059
Diethylamine	Amine	Liquid	4	9.5
N,N-Dimethylformamide	Amide	Liquid	8	2.1
Ethyl Acetat	Ester, Carboxylic	Liquid	4	3.3
Ethylene Oxide	Heterocyclic Compound	Gas	<4	359
n-Hexane	Hydrocarbon	Liquid	4	6.3
Hydrogen Chloride	Inorganic Gas	Gas	30	>50
Methanol	Hydroxylic Compound	Liquid	<4	2.23
Methyl Chloride	Halogen Compound	Gas	4	0.38
Nitrobenzene	Nitro Compound	Liquid	4	16
Sodium Hydroxide	Inorganic Gas	Liquid	ND	ND
Sulfuric Acid	Inorganic Gas	Liquid	ND	ND
Tetrachloroethylene	Halogen Compound	Liquid	8	10
Tetrahydrofuran	Ether	Liquid	<4	>50
Toluene	Hydrocarbon	Liquid	8	25



3678B



3702



3718

Posiwear® Ultimate Barrier™

- Protects against chemicals, dry particulates, light sprays and liquid splash
- ASTM 1670 and 1671 for viral and bloodborne pathogens
- ASTM F739 and F903 for many chemicals
- Low lint - NFPA 99 Anti-static

Posiwear® Ultimate Barrier™

STYLE NUMBER	GARMENT	CONFIGURATION	CLOSURE	MATERIAL	SEAM TYPE	COLOR	SIZE	PACKAGING
3678B	Coverall	Elastic Wrists and Ankles with Hood	Zipper	Polyethylene Film / Melt-Blown Adhesive / Spunbond Polypropylene	Bound	Yellow	M-5XL	25 / case
3679B	Coverall	Elastic Wrists, Hood and Boots	Zipper	Polyethylene Film / Melt-Blown Adhesive / Spunbond Polypropylene	Bound	Yellow	M-5XL	25 / case
3700	Coverall	Zippered Front	Zipper	Polyethylene Film / Spunbond Polypropylene	Serged	White	M-5XL	25 / case
3702	Coverall	Elastic Wrists and Ankles	Elastic	Polyethylene Film / Spunbond Polypropylene	Serged	White	M-5XL	25 / case
3706	Coverall	Elastic Wrists and Ankles with Hood	Elastic	Polyethylene Film / Spunbond Polypropylene	Serged	White	M-5XL	25 / case
3709	Coverall	Elastic Wrists, Hood and Boots	Zipper	Polyethylene Film / Spunbond Polypropylene	Serged	White	M-4XL	25 / case
3712	Sleeve	-	Elastic	Polyethylene Film / Spunbond Polypropylene	Serged	White	18"	200 / case
3713	Shoe Cover	-	Elastic	Polyethylene Film / Spunbond Polypropylene	Serged	White	OS	200 / case
3714	Boot Cover	-	Elastic	Polyethylene Film / Spunbond Polypropylene	Serged	White	OS	200 / case
3718	Lab Coat	Snap Front Closure	Snap	Polyethylene Film / Spunbond Polypropylene	Serged	White	L-3XL	30 / case
3722	Apron	-	Tied Waist	Polyethylene Film / Spunbond Polypropylene	Serged	White	28" x 36"	100 / case



Breathable Advantage™

Petrochemical Industry / Refinery / Manufacturing /
Cleaning and Industrial Maintenance / Construction /
Automotive Refinishing / Pharmaceutical Industry /
Asbestos Removal / Waste Disposal



Scan it



MATERIAL COMPOSITION

PolyBreathe® Light material is a two-layer composite of microporous PE film (MPPE) adhesive bonded to SBPP. It has pores large enough for water vapor (sweat) to pass through, yet small enough to keep out water droplets. It is a breathable and cool material.

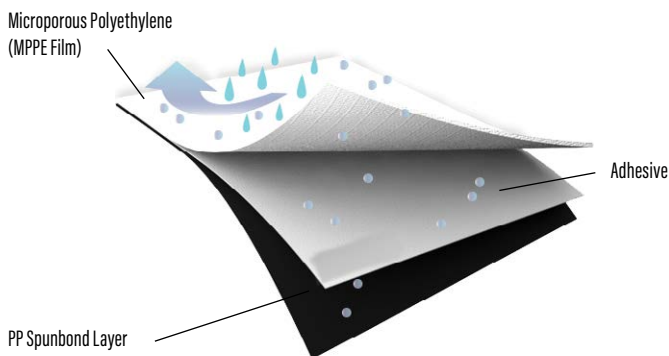

Posiwear® Breathable Advantage™ Typical Properties

PHYSICAL PROPERTY	TEST METHODS	UNITS	POSIWEAR® FR
Strength			
Weight	IST 1130.1	gsm	57.63/1.7oz
MD Tensile (Grab)	IST 110.1	lb/in	27.5
CD Tensile (Grab)	IST 110.1	lb/in	18.3
MD Elongation	IST 110.1	%	71.7
CD Elongation	IST 110.1	%	79.2
MD Tear Strength (Trapezoid)	IST 100.2	lb/in	7.3
CD Tear Strength (Trapezoid)	IST 100.2	lb/in	11.1
Bursting Strength (Mullen Burst)	IST 30.1	psi	32
Barrier			
Hydrostatic Head	IST 80.6-01 (testex)	cm	191.3
Static Decay (MD) (50%RH) NFPA 99	IST 40.2	sec	Pass
Resistance to Blood Penetration	ASTM	n/a	Pass
Comfort			
M.V.T.R.	IST 70.2	g/m2/day	2863



3606
Coverall

Posiwear® Breathable Advantage™

- Protects against small dry particulates, light spray and liquid splash

- Breathable material
- ASTM 1670 for Blood Penetration Resistance

- NFPA 99 Anti-static
- Low lint



3622
Apron



3614
Boot Cover



3613
Shoe Cover

Posiwear® Breathable Advantage™

STYLE NUMBER	GARMENT	CONFIGURATION	CLOSURE	MATERIAL	SEAM TYPE	COLOR	SIZE	PACKAGING
3600	Coverall	Zippered Front	Zipper	Microporous Polyethylene Film / Spunbond Polypropylene	Serged	White	M-5XL	25 / case
3602	Coverall	Elastic Wrists and Ankles	Zipper	Microporous Polyethylene Film / Spunbond Polypropylene	Serged	White	M-5XL	25 / case
3606	Coverall	Elastic Wrists and Ankles with Hood	Zipper	Microporous Polyethylene Film / Spunbond Polypropylene	Serged	White	M-5XL	25 / case
3609	Coverall	Elastic Wrists, Hood and Boots	Zipper	Microporous Polyethylene Film / Spunbond Polypropylene	Serged	White	M-5XL	25 / case
3612	Sleeve	-	Elastic	Microporous Polyethylene Film / Spunbond Polypropylene	Serged	White	18"	200 / case
3613	Shoe Cover	-	Elastic	Microporous Polyethylene Film / Spunbond Polypropylene	Serged	White	OS	200 / case
3614	Boot Cover	-	Elastic	Microporous Polyethylene Film / Spunbond Polypropylene	Serged	White	OS	200 / case
3616	Pant	Elastic Waist	Elastic	Microporous Polyethylene Film / Spunbond Polypropylene	Serged	White	M-4XL	50 / case
3617	Shirt	Snap Front Closure	Snap	Microporous Polyethylene Film / Spunbond Polypropylene	Serged	White	L-3XL	50 / case
3620	Lab Coat	Snap Front Closure with 2 Pockets	Snap	Microporous Polyethylene Film / Spunbond Polypropylene	Serged	White	M-4XL	30 / case
3622	Apron	-	Tied Waist	Microporous Polyethylene Film / Spunbond Polypropylene	Serged	White	28" x 36"	100 / case



M3™

Construction / Industrial Maintenance /
Waste Disposal / Food Processing /
Heavy Dust Environments / Manufacturing



Scan it



MATERIAL COMPOSITION

Pentamax® consists of five layers of polypropylene for enhanced personal protection. There are two layers of spunbond polypropylene for strength and durability, sandwiching three layers of melt blown for higher barrier and filtration. The small fiber size and pore size makes this the perfect choice for protection against dry particulates and light liquid sprays.

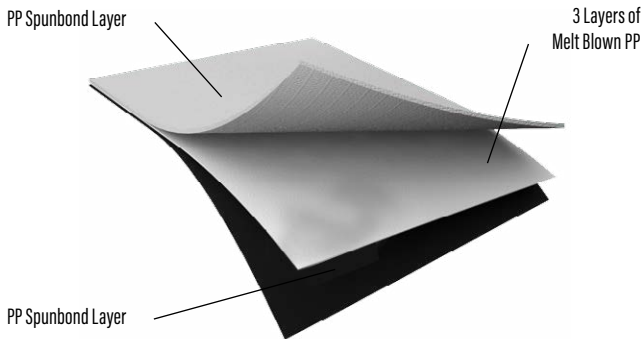

Posiwear® M3 Typical Properties

DESCRIPTION	TEST METHODS	UNITS	POSIWEAR® M3
Strength			
Base Weight	IST 130.1	gsm	55/1.6oz/yd ²
Grab Tensile	ASTM D5034	lb.	36.7
Trap Tear	ASTM D5733	lb.	6.5
Surface Resistance	IST 80.6	N	0.99
Impact Penetration	AATCC 42	gsm	0.05
Barrier			
Hydrostatic Pressure	AATCC 127	cm	85
Comfort			
Air Permeability	IST 70.1	cfm	38



C3802
Coverall



C3909
Coverall



C3812
Sleeve



C3817
Shirt



C3816
Pant

Posiwear® M3™

- Five layers provide a higher barrier against dry particulate and light liquid spray than standard SMS materials
- NFPA 99 Anti-static
- High level of breathability
- 21 CFR Compliant

Posiwear® M3™

STYLE NUMBER	GARMENT	CONFIGURATION	CLOSURE	MATERIAL	SEAM TYPE	COLOR	SIZE	PACKAGING
BC3817	Lab Coat	Snap Front Closure	Snap	Spunbond Polypropylene Double Layer / Melt Blown Polypropylene Triple Layer	Serged	Blue	M-7XL	50 / case
C3800	Coverall	Zippered Front	Zipper	Spunbond Polypropylene Double Layer / Melt Blown Polypropylene Triple Layer	Serged	White	M-5XL	25 / case
C3802	Coverall	Elastic Wrists and Ankles	Zipper	Spunbond Polypropylene Double Layer / Melt Blown Polypropylene Triple Layer	Serged	White	M-5XL	25 / case
C3806	Coverall	Elastic Wrists and Ankles with Hood	Zipper	Spunbond Polypropylene Double Layer / Melt Blown Polypropylene Triple Layer	Serged	White	M-5XL	25 / case
C3809	Coverall	Elastic Wrists, Hood and Boots	Zipper	Spunbond Polypropylene Double Layer / Melt Blown Polypropylene Triple Layer	Serged	White	M-5XL	25 / case
C3812	Sleeve	-	Elastic	Spunbond Polypropylene Double Layer / Melt Blown Polypropylene Triple Layer	Serged	White	OS	200 / case
C3813	Shoe Cover	-	Elastic	Spunbond Polypropylene Double Layer / Melt Blown Polypropylene Triple Layer	Serged	White	OS	200 / case
C3816	Pant	Elastic Waist	Elastic	Spunbond Polypropylene Double Layer / Melt Blown Polypropylene Triple Layer	Serged	White	L-3XL	50 / case
C3817	Shirt	Snap Front Closure	Snap	Spunbond Polypropylene Double Layer / Melt Blown Polypropylene Triple Layer	Serged	White	M-4XL	50 / case
C3818	Lab Coat	Snap Front Closure	Snap	Spunbond Polypropylene Double Layer / Melt Blown Polypropylene Triple Layer	Serged	White	M-4XL	30 / case
C3819	Lab Coat	Snap Front Closure	Snap	Spunbond Polypropylene Double Layer / Melt Blown Polypropylene Triple Layer	Serged	White	M-6XL	30 / case
C3820	Lab Coat	Snap Front Closure with 2 Pockets	Snap	Spunbond Polypropylene Double Layer / Melt Blown Polypropylene Triple Layer	Serged	White	M-5XL	30 / case
C3900	Coverall	Zippered Front	Zipper	Spunbond Polypropylene Double Layer / Melt Blown Polypropylene Triple Layer	Serged	Gray	M-5XL	25 / case
C3902	Coverall	Elastic Wrists and Ankles	Zipper	Spunbond Polypropylene Double Layer / Melt Blown Polypropylene Triple Layer	Serged	Gray	M-4XL	25 / case
C3906	Coverall	Elastic Wrists and Ankles with Hood	Zipper	Spunbond Polypropylene Double Layer / Melt Blown Polypropylene Triple Layer	Serged	Gray	M-5XL	25 / case
C3909	Coverall	Elastic Wrists, Hood and Boots	Zipper	Spunbond Polypropylene Double Layer / Melt Blown Polypropylene Triple Layer	Serged	Gray	L-5XL	25 / case
C3913	Boot Cover	-	Elastic	Spunbond Polypropylene Double Layer / Melt Blown Polypropylene Triple Layer	Serged	Gray	OS	200 / case



Scan it



PE Laminated SBP

MATERIAL COMPOSITION

The PE Laminated line is polypropylene with a polyethylene film that provides lightweight, comfortable protection against nonhazardous light spray and splash.

PIP® PE Laminated SBP

- A single layer of spunbond polypropylene enhanced with polyethylene film for protection against non-hazardous particulates and liquids

- Strong and durable material
- Excellent barrier protection



3406
Coverall



U2510B
Apron



3763
Shoe Cover



C3712
Sleeve

PIP® PE Laminated SBP

STYLE NUMBER	GARMENT	CONFIGURATION	CLOSURE	MATERIAL	SEAM TYPE	COLOR	SIZE	PACKAGING
3400	Coverall	Zippered Front	Zipper	Polyethylene Film / Spunbond Polypropylene	Serged	White	L-5XL	25 cs
3402	Coverall	Elastic Wrists and Ankles	Zipper	Polyethylene Film / Spunbond Polypropylene	Serged	White	L-5XL	25 cs
3406	Coverall	Elastic Wrists and Ankles with Hood	Zipper	Polyethylene Film / Spunbond Polypropylene	Serged	White	L-5XL	25 cs
3409	Coverall	Elastic Wrists, Hood and Boots	Zipper	Polyethylene Film / Spunbond Polypropylene	Serged	White	L-5XL	25 cs
3620	Lab Coat	Snap Front Closure with 2 Pockets	Snap	Polyethylene Film / Spunbond Polypropylene	Serged	White	M-4XL	30 cs
3763	Shoe Cover	-	Elastic	Polyethylene Film / Spunbond Polypropylene	Serged	White	One Size	200 cs
3764	Boot Cover	-	Elastic	Polyethylene Film / Spunbond Polypropylene	Serged	White	One Size	200 cs
C3712	Sleeve	-	Elastic	Polyethylene Film / Spunbond Polypropylene	Serged	White	One Size	200 cs
U2510B	Apron	-	Tied Waist	Polyethylene Film / Spunbond Polypropylene	Serged	Blue	One Size	100 cs



Scan it



MPPE SBP



MATERIAL COMPOSITION

This fabric has a layer of microporous polyethylene (MPPE) film bonded to a layer of spunbond polypropylene (SBP). The breathable microporous material protects against dry particulates and liquid sprays. A lighter, lower-cost alternative to the Posiwear® Breathable Advantage line, which offers better protection due to a smaller pore size in the film.

PIP® MPPE SBP

- Microporous polyethylene film bonded to a single layer of polypropylene
- Film pores allow vapor to evaporate while protecting against liquid sprays and particulates
- Provides reliable barrier protection against non-hazardous liquid sprays and particulates while keeping the user comfortable

Light, breathable protection
against liquid splash and sprays

3652
Coverall

PIP® MPPE SBP

STYLE NUMBER	GARMENT	CONFIGURATION	CLOSURE	MATERIAL	SEAM TYPE	COLOR	SIZE	PACKAGING
3652	Coverall	Elastic Wrists and Ankles	Zipper	Microporous Polyethylene Film / Spunbond Polypropylene	Serged	White	M-5XL	25 cs
3650	Coverall	Zippered Front	Zipper	Microporous Polyethylene Film / Spunbond Polypropylene	Serged	White	M-5XL	25 cs
3656	Coverall	Elastic Wrists and Ankles with Hood	Zipper	Microporous Polyethylene Film / Spunbond Polypropylene	Serged	White	M-5XL	25 cs
3659	Coverall	Elastic Wrists, Hood and Boots	Zipper	Microporous Polyethylene Film / Spunbond Polypropylene	Serged	White	M-5XL	25 cs



Scan it



SMS



C3852
Coverall

C3859
Coverall

MATERIAL COMPOSITION

Spunbond/melt-blown/spunbond (SMS) technology provides three layers of filtration and durability for a high level of breathability and protection against non-hazardous dry particulates and light liquid sprays and splashes.

PIP® SMS

- Lightweight polypropylene filtration layer between double layers of durable polypropylene
- Comfortable and breathable garment with three layers of filtration

- Protects against non-hazardous dry particulates and light liquid sprays and splashes

Three bonded layers
for durable filtration

PIP® SMS

STYLE NUMBER	GARMENT	CONFIGURATION	CLOSURE	MATERIAL	SEAM TYPE	COLOR	SIZE	PACKAGING
BC3852	Coverall	Elastic Wrists and Ankles	Zipper	Spunbond / Melt-Blown / Spunbond	Serged	White	M-5XL	25 cs
BC3856	Coverall	Elastic Wrists and Ankles with Hood	Zipper	Spunbond / Melt-Blown / Spunbond	Serged	Blue	M-5XL	25 cs
C3850	Coverall	Zippered Front	Zipper	Spunbond / Melt-Blown / Spunbond	Serged	White	M-5XL	25 cs
C3852	Coverall	Elastic Wrists and Ankles	Zipper	Spunbond / Melt-Blown / Spunbond	Serged	White	M-5XL	25 cs
C3856	Coverall	Elastic Wrists and Ankles with Hood	Zipper	Spunbond / Melt-Blown / Spunbond	Serged	White	M-5XL	25 cs
C3859	Coverall	Elastic Wrists, Hood and Boots	Zipper	Spunbond / Melt-Blown / Spunbond	Serged	White	M-5XL	25 cs



Scan it

PIP

SBP



3515
Shirt



3512LB
Lab Coat

MATERIAL COMPOSITION

Spunbond polypropylene (SBP) disposable clothing is strong and durable, providing affordable, lightweight protection against non-hazardous dry particulates. It comes in two different gram weights – standard and heavyweight.

PIP® SBP

- Spunbond polypropylene double layers for increased strength and durability
- Economic protection against non-hazardous dry particulates



3506
Coverall

PIP® SBP

STYLE NUMBER	GARMENT	CONFIGURATION	CLOSURE	MATERIAL	SEAM TYPE	COLOR	SIZE	PACKAGING
3500	Coverall	Zippered Front	Zipper	Spunbond Polypropylene	Serged	White	M-5XL	25 cs
3502	Coverall	Elastic Wrists and Ankles	Zipper	Spunbond Polypropylene	Serged	White	M-5XL	25 cs
3506	Coverall	Elastic Wrists and Ankles with Hood	Zipper	Spunbond Polypropylene	Serged	White	M-5XL	25 cs
3509	Coverall	Elastic Wrists, Hood and Boots	Zipper	Spunbond Polypropylene	Serged	White	M-5XL	25 cs
3511	Lab Coat	Snap Front Closure with 2 Pockets	Snap	Spunbond Polypropylene	Serged	White	M-5XL	30 cs
3511B	Lab Coat	Snap Front Closure	Snap	Spunbond Polypropylene	Serged	White	M-5XL	30 cs
3512	Lab Coat	Snap Front Closure with Elastic Wrists	Snap	Spunbond Polypropylene	Serged	White	M-5XL	30 cs
3512LB	Lab Coat	Snap Front Closure with Elastic Wrists	Snap	Spunbond Polypropylene	Serged	Light Blue	M-5XL	30 cs
3514	Lab Coat	Snap Front Closure with 2 Pockets	Snap	Spunbond Polypropylene	Serged	White	M-5XL	30 cs
3515	Shirt	Snap Front Closure	Snap	Spunbond Polypropylene	Serged	White	M-4XL	50 cs
3516	Pants	Elastic Waist	Elastic	Spunbond Polypropylene	Serged	White	M-5XL	50 cs
3518	Shoe Cover	-	Elastic	Polypropylene	Serged	Blue	OS	200/case
3518BNS	Shoe Cover	-	Elastic	Spunbond Polypropylene	Serged	Blue	One Size	200 cs
3519	Boot Cover	-	Elastic	Spunbond Polypropylene	Serged	White	One Size	200 cs
3575	Coverall	Zippered Front	Zipper	Spunbond Polypropylene	Serged	Navy	M-5XL	25 cs
3584	Coverall	Elastic Wrists and Ankles with Hood	Zipper	Spunbond Polypropylene	Serged	Navy	M-5XL	25 cs
C3828	Lab Coat	Snap Front Closure with Knit Wrists	Snap	Spunbond Polypropylene	Serged	White	M-5XL	25 cs
U2010	Boxer Shorts	Elastic Waist	Elastic	Spunbond Polypropylene	Serged	White	One Size	100 cs
U2400B	Sleeve	-	Elastic	Polypropylene	Serged	Blue	OS	200/case
USK-065	Smock	Tied Waist, Elastic Wrist	Tied Waist	Spunbond Polypropylene	Serged	White	One Size	50 cs



Scan it



Disposable Accessories

HAIR AND BEARD COVERINGS



COMPLIES WITH FEDERAL REGULATIONS FOR FOOD CONTACT: 21 CFR, 170-199

UB-1000B
Bouffant

UBC-1000B
Beard Cover

BODY PROTECTION



USK-065
Smock

24PE
Sleeve

Hair and Beard Coverings

STYLE NUMBER	GARMENT	CLOSURE	MATERIAL	COLOR	SIZE	PACKAGING
UB-1000	Bouffant	Elastic	Spunbond Polypropylene	White	18", 21", 24", 28"	1000/case
UB-1000B	Bouffant	Elastic	Spunbond Polypropylene	Blue	21", 24"	1000/case
UB-1000G	Bouffant	Elastic	Spunbond Polypropylene	Green	21", 24"	1000/case
UB-1000R	Bouffant	Elastic	Spunbond Polypropylene	Red	21", 24"	1000/case
UB-1000OR	Bouffant	Elastic	Spunbond Polypropylene	Orange	21"	1000/case
UBC-1000	Beard Cover	Elastic	Spunbond Polypropylene	White	18"	1000/case
UBC-1000B	Beard Cover	Elastic	Spunbond Polypropylene	Blue	18"	1000/case
UC-1000	Hair Net	Elastic	Nylon	White	18", 21", 24", 28"	1000/case
UCBC-1000	Beard Cover	Elastic	Nylon	White	19"	1000/case
UCBLK-1000	Hair Net	Elastic	Nylon	Black	21", 24"	1000/case
UP-1000	Bouffant - Pleated	Elastic	Spunbond Polypropylene	White	21", 24"	1000/case

Body Protection

STYLE NUMBER	GARMENT	CLOSURE	MATERIAL	SEAM TYPE	COLOR	SIZE	PACKAGING
2418PE	Sleeve	Elastic	Polyethylene	Serged	White	16"	1000 cs
2418PE	Sleeve	Elastic	Polyethylene	Serged	White	18"	1000 cs
2418PEB	Sleeve	Elastic	Polyethylene	Serged	Blue	18"	1000/case
2418PEY	Sleeve	Elastic	Polyethylene	Serged	Yellow	18"	1000 cs
2846PE	Apron - 1 mil	Tied Waist	Polyethylene	No Seams	White	28" x 46"	1000/case
24PE	Sleeve	Elastic	Polyethylene	Serged	White	16"-18"	1000/case
24PEY	Sleeve	Elastic	Polyethylene	Serged	Yellow	18"	1000/case
DP-46	Apron - 1.5 mil	Tied Waist	Polyethylene	No Seams	White	28" x 46"	100/box
DP-55	Apron - 1.5 mil	Tied Waist	Polyethylene	No Seams	White	28" x 55"	100/box

SECTION:

Safety Boots



MADE FOR WORKING™

This section contains important PPE related to foot protection. These boots were designed to provide workers with all-day comfort and protection against the hazards they face daily in their work environments. From handling heavy objects, to standing on wet or uneven substrates, or handling chemicals, PIP® offers a complete line of PVC, rubber, polyblend and neoprene safety boots to protect workers on the jobsite.

PRODUCTS

Over-the-Sock

Designed for all-day comfort.

Over-the-Shoe

Easily fits over the worker's shoe, making it easy to transition from wet to dry environments.



SLIPPING OR
TRIPPING



STRUCK-BY-HAZARDS



SHARP
OBJECTS



LIQUID
SPASH



Boss® Footwear is designed with advanced materials that offer maximum comfort and protection against work hazards across multiple industries.

NOT JUST A BOOT

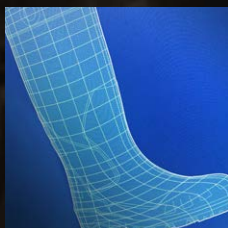

Innovative Design

Made with materials that are **up to 25% lighter** than traditional, heavy PVC boots. Optimized design follows the shape of legs and ankles to improve comfort when walking.

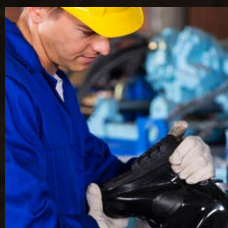

Injected-Molded Technology

Results in higher quality boots **PLUS** greater flexibility, durability and more advanced protection.

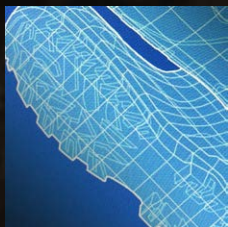

Energy-Absorbing Outsole

Paired with an energy-absorbing outsole design that channels water, grease and mud outward. PIP's Boss® Footwear is designed to provide better coverage, flex and traction.

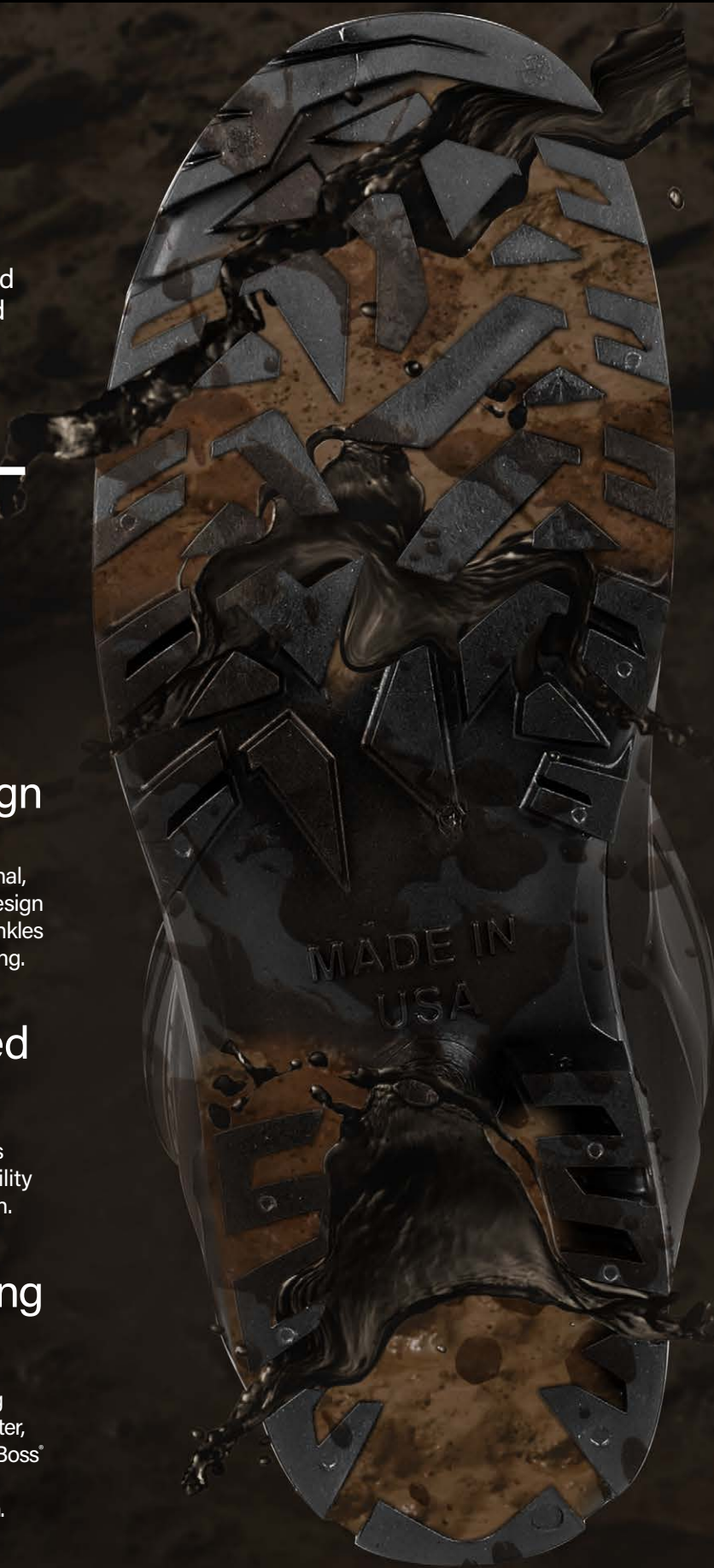

16" Polyblend Steel Toe and Shank Boot

383-890

- Polyblend compound offers superior resistance to fats, oils, and chemicals
- Steel shank provides improved support and ladder stability
- Lug outsole multi-tread design provides exceptional comfort and slip resistance especially in wet conditions
- Sleek upper design and material provides all-day comfort and improved durability over PVC
- Less toe spring allows for more surface contact, improved traction/slip resistance and comfort
- Pre-formed removable insole wicks perspiration away to keep feet dry and comfortable
- "Kick off" ledge on back of boots for ease of removal
- Meets ASTM F2413-18 M/I/C Impact and Compression

APPLICATIONS



CONSTRUCTION



INDUSTRIAL



OIL & GAS
AND MINING



AGRICULTURE



FOOD PROCESSING



**STEEL TOE
& SHANK**

**LIGHTWEIGHT AND DURABLE PROTECTION AGAINST
FATS, OILS AND SLIP HAZARDS**

STYLE	MATERIAL	COLOR	LENGTH	TOE TYPE	STEEL SHANK	STEEL MIDSOLE	TREAD PATTERN	ASTM F2413 COMPLIANT	CSA COMPLIANT	SIZES
383-890	Polyblend	Black / Gray	16"	Steel	Yes	No	Power-Lug	Yes	No	6-14



Scan it



Polyblend Boots

**PREMIUM MATERIAL OFFERS SUPERIOR
RESISTANCE TO OILS AND GREASE**





PVC Boots

**LIGHTWEIGHT,
MODERN DESIGN
UP TO 25% LIGHTER
THAN CLASSIC PVC BOOTS**



Scan it



**FULL SAFETY
STEEL TOE
& MIDSOLE**

383-820

**ENHANCED DURABILITY,
PROTECTION AND COMFORT**

16" PVC Full Safety Steel Toe and Midsole Boot

383-820

- Flexible steel puncture resistant mid-sole reduces risks from sharp objects and meets ASTM F2413 PR
- Energy absorbing tread adds all-day comfort
- Less toe spring allows for more surface contact for improved channeling of water for better traction, slip resistance and comfort
- Tough outsole for good abrasion resistance
- Flexible upper material stays supple in cold temperatures to make walking easier
- Midsole is designed to utilize additional material in the standard area of the shank providing increased support and comfort
- Lower profile "kick off" ledge on back of boots for ease of removal
- Meets ASTM F2413-18 M/1/C Impact and Compression
- CSA Certified

APPLICATIONS



CONSTRUCTION



REMEDIATION



ENVIRONMENTAL
CLEAN UP



FORESTRY



CONCRETE WORK



MUNICIPAL



**INCREASED SUPPORT
AND COMFORT**



IDEAL FOR THE CONCRETE WORK
382-910 *White*



IDEAL FOR CONSTRUCTION
382-810 *Black*

16" PVC Steel Toe Boots

382-810 *Black*
382-910 *White*

- Energy-absorbing tread adds all-day comfort
- Less toe spring allows for more surface contact for improved channeling of water for better traction, slip resistance and comfort
- Tough outsole for good abrasion resistance
- Flexible upper material stays supple in cold temperatures to make walking easier
- Pre-formed removable insole wicks perspiration away to keep feet dry and comfortable
- Midsole is designed to utilize additional material in the standard area of the shank providing increased support and comfort
- Low profile "kick off" ledge on back of boots for ease of removal
- Meets ASTM F2413-18 M/1/C Impact and Compression

APPLICATIONS



IDEAL FOR AGRICULTURE
380-800 *Black*



IDEAL FOR THE FOOD INDUSTRY
380-900 *White*

16" PVC Plain Toe Boots

380-800 *Black*
380-900 *White*

- Energy-absorbing tread adds all-day comfort
- Less toe spring allows for more surface contact for improved channeling of water for better traction, slip resistance and comfort
- Tough outsole for good abrasion resistance
- Flexible upper material stays supple in cold temperatures to make walking easier
- Pre-formed removable insole wicks perspiration away to keep feet dry and comfortable
- Midsole is designed to utilize additional material in the standard area of the shank providing increased support and comfort
- Low profile "kick off" ledge on back of boots for ease of removal

APPLICATIONS



STYLE	MATERIAL	COLOR	LENGTH	TOE TYPE	STEEL SHANK	STEEL MIDSOLE	TREAD PATTERN	ASTM F2413 COMPLIANT	CSA COMPLIANT	SIZES
383-820	PVC	Black	16"	Steel	No	Yes	Cleated	Yes	Yes	6-14
382-810	PVC	Black	16"	Steel	No	No	Cleated	Yes	No	6-14
382-910	PVC	White / Tan	16"	Steel	No	No	Cleated	Yes	No	6-14
380-800	PVC	Black	16"	Plain	No	No	Cleated	No	No	6-14
380-900	PVC	White / Tan	16"	Plain	No	No	Cleated	No	No	6-14



OVER-THE-SOCK



BLACK NEOPRENE PLAIN TOE BOOT

2NP1001

- Treaded sole provides great grip and traction
- Steel shank for stability
- Lighter than rubber boots

APPLICATIONS

FARM AND RANCH - PUBLIC WORKS - TRANSPORTATION

16"



BLACK RUBBER BOOT WITH REINFORCED TOE CAP

2KP5221

- Bar-tread non-slip outer sole
- Cushioned insole
- Fabric lined
- Reinforced toe cap
- Steel shank

APPLICATIONS

CONSTRUCTION - REMEDIATION - ENVIRONMENTAL CLEAN UP - FORESTRY

15"



BLACK RUBBER HIP BOOT WITH STEEL TOE

2HS6231

- Adjustable buckle closure
- Belt loop strap
- Steel toe and reinforced knee

APPLICATIONS

CONSTRUCTION - OIL & GAS AND MINING - MANUFACTURING
FOOD PROCESSING - GENERAL INDUSTRIAL

34"

OVER-THE-SHOE



BLACK RUBBER 5 BUCKLE BOOT

2PP6297

- Bar-tread outer sole
- Fabric lined
- 5 adjustable buckles

APPLICATIONS

CONSTRUCTION - ROAD WORK - REMEDIATION

14"



YELLOW RUBBER SLUSH BOOT

2KP4481

- Bar-tread non-slip outer sole
- Fabric lined
- Top strap and buckle

APPLICATIONS

CONSTRUCTION - ROAD WORK - REMEDIATION
UTILITIES - ENVIRONMENTAL CLEAN UP

17"



YELLOW RUBBER OVER-THE-SHOE BOOT

8400

- Heavyweight rubber shoe/boot cover
- Textured sole for traction
- Lightweight and easy to store

APPLICATIONS

MANUFACTURING - ENVIRONMENTAL CLEAN UP

12"



ENGINEERED VALUE LINE THAT OFFERS AN EXCELLENT

Barrier against liquids

Scan it

STYLE	MATERIAL	COLOR	LENGTH	TOE TYPE	STEEL SHANK	STEEL MIDSOLE	TREAD PATTERN	ASTM F2413 COMPLIANT	CSA COMPLIANT	SIZES
2NP1001	Neoprene / Rubber	Black	16"	Plain	Yes	No	Cleated	No	No	8-13
2KP5221	Rubber	Black / Red	15"	Plain	Yes	No	Bar-Tread	No	No	5-14
2HS6231	Rubber	Black / Yellow	34"	Steel	Yes	No	Bar-Tread	No	No	7-14
2PP6297	Rubber	Black / Red	14"	Plain	No	No	Bar-Tread	No	No	9-16
2KP4481	Rubber	Yellow / Black	17"	Plain	No	No	Bar-Tread	No	No	7-18
8400	Rubber	Yellow	12"	Plain	No	No	Rough	No	No	M-2XL

For Over-The-Shoe styles consider one size larger

Safety Aids

Whether conducting repetitive tasks or working in a high-risk environment, workers need protection for themselves and their equipment to safeguard others from hazards and treat potential workplace injuries.



DIRECT
SUNLIGHT



BODILY WEAR
AND TEAR



PAIN, INFECTION OR FURTHER
INJURY



COLLISION



UNTETHERED
TOOLS

206

HEAT STRESS is a hazard that millions of workers are exposed to. Manage heat stress with PPE technology that's designed to cool and evaporate moisture away from skin, provide sun protection and reduce the risk of hindered vision by absorbing and wicking away sweat before it can reach the eyes.

215

EMERGENCY BEACONS are essential in providing instant visibility in situations where low to no visibility is a substantial hazard. While flares create the inherent risk of open flame, toxic fumes and residue – with incandescent and strobe lights potentially causing point fixation and distance judgment issues – EFLARE™ beacons use LED technology to produce an intensely bright display that projects at an angle that will not dazzle or impede the vision of drivers.

219

FIRST AID kits that meet the ANSI Z308.1-2015 performance standard are separated into Class A and Class B. They are differentiated by the assortment and quantity of each item based on the hazard level of the work environment and the anticipated number of user injuries that may occur. Class A kits are designed to address the most common types of workplace injuries, while Class B kits offer a broader range of supplies for injuries that can occur in a high-risk environment.

223

ERGONOMIC protective wear is designed to mitigate the strains of repetitive tasks and overall wear and tear on the body. Sleeves and supports for wrists, elbows and knees reduce discomfort and strain, while lumbar supports relieve back pressure and provide stability.

227

TOOL TETHERING accessories meet the ANSI/ISEA 121 standard as an active prevention practice intended to mitigate the risk of falling objects by securing or containing them while working at heights. Tool tethers are designed to securely attach to tools, helping prevent dangerous drops while providing the user with freedom of mobility and unimpeded functionality.

SECTION:

Heat Stress



From Discomfort to Danger in Minutes

This section contains important PPE related to heat stress. Workers experiencing heat stress can present a range of responses, from cramps to dizziness and even death. To avoid the danger, it is essential that workers stay hydrated and stay cool.

Risk of heat stress increases as the Heat Index increases. This measure reflects both heat and relative humidity, which impact our body's ability to regulate temperature since perspiration or sweat is less able to evaporate and cool us off. Small variations in our body temperature can affect our performance and health greatly. Just a two-degree rise in body temperature may affect mental acuity, and a five-degree increase can result in serious injuries related to heat stroke.



PHASE CHANGE COOLING TECHNOLOGY

Vests that feature **Phase Change Technology** use a phase change pack to cool down the wearer. First, cold temperature is absorbed by the phase change material, changing it from a clear liquid to an opaque solid as it is activated. Next, the activated phase change pack is placed into the vest and worn against the body. The cold temperature is transferred to the wearer as the latent heat is absorbed by the phase change material.



EVAPORATIVE COOLING TECHNOLOGY

Cooling Vests use **Evaporative Technology**, where water is absorbed by the product's cooling fibers, and cooling occurs as the moisture within the unit evaporates. To facilitate cooling, the vests are worn over other garments, exposed to moving air. The vest fabric ensures a uniform cooling effect while staying lightweight and easy to use.

Other wearables, including hats, bandanas, neck shades, neck gaiters and sleeves are also available with evaporative cooling.



HEAT &
HUMIDITY



PHYSICAL
EXERTION



DEHYDRATION



HEAT
CRAMPS



HEAT
EXHAUSTION



HEAT
STROKE



ABSORPTIVE COOLING TECHNOLOGY

Absorptive Technology is found in versatile sweatbands and neck gaiters that can trap perspiration and keep it out of the eyes for a safer, more comfortable job with fewer distractions.



SUN PROTECTION COOLING TECHNOLOGY

Sun Protection is provided by hats and neck shades that use lightweight fabrics to shade the head and neck and help to keep the head ventilated and cool.



Scan it



Cooling Apparel

WEAR UNDER OR OVER
OTHER GARMENTS



PHASE CHANGE
COOLING TECHNOLOGY



390-EZSPC

390-EZFRPC

FR OUTER SHELL



Cooling pack
inserts and
cooler bag

390-PC099



390-PCVKT1

- Cooling properties can be reactivated for the life of the product
- Provides comfortable cooling up to 3 hours



Replacement
cooling pack

390-PCVCP1

EZ-COOL' PHASE CHANGE ACTIVE FIT COOLING VESTS

390-EZSPC | 390-EZFRPC

- V-neck with zipper closure and contoured design for a better fit while active
- Cooling effects last for up to 3 hours
- Flame-resistant Banwear cotton shell (390-EZFRPC)
- Cotton and Nylon blended shell (390-EZSPC)
- Adjustable at shoulders and torso with hook and loop for snug, less bulky fit

EZ-COOL' REPLACEMENT COOLING PACKS

390-PC099

- Fits with items 390-EZSPC and 390-EZFRPC
- Cooling packs freeze at 58°-60° F with a set time of 45 minutes and maintain that temp for 2-3 hours as they absorb heat changing from a solid to a liquid

Phase Change Cooling Vests

STYLE	COOLING TYPE	ACTIVATION TIME	OUTER FABRIC	INNER FABRIC	WEIGHT	CLOSURE	COLOR	SIZE
390-EZFRPC	Phase Change Cooling	45 Minutes	Banwear FR Cotton	100% Cotton	5.0 lbs	Zipper with Side & Shoulder Adjustments	Navy	M/L, L/XL, 2X/3X
390-EZSPC	Phase Change Cooling	45 Minutes	100% Cotton	Nylon	5.0 lbs	Zipper with Side & Shoulder Adjustments	Blue	M/L, L/XL, 2X/3X
390-PC099	Phase Change Cooling	45 Minutes	Polyurethane	Alkane Blend	-	-	Clear	OS
390-EZHYPC	Phase Change Cooling	45 Min. or 1-2 Min.	Polyester / Spandex	HyperKewl™ Plus / Nylon	4.0 lbs	Zipper	Red	M-3X
390-HY099	Phase Change Cooling	45 Minutes	Polyurethane	Alkane Blend	-	-	Clear	OS
390-PCVKT1	Phase Change Cooling	45 Minutes	Nylon	Nylon	6.0 lbs	Pullover with Side & Shoulder Adjustments	Navy	M-L
390-PCVCP1	Phase Change Cooling	45 Minutes	Polyurethane	Alkane Blend	-	-	Clear	OS



Evaporative Cooling



390-EZ150
 - Can be worn over a breathable shirt, but designed to be worn against the skin
 - 1-2 minute activation time and can provide 5-10 hours of cooling relief per activation
 - Built-in ventilation on sides and back



390-EZ100
 - Lightweight, easy to activate and durable
 - 1-2 minute activation time and can provide 5-10 hours of cooling relief per activation
 - V-neck design with zipper closure



390-EZ202
 - ANSI/ISEA 107 Type R Class 2
 - 1-2 minute activation time and can provide 5 hours of cooling relief per activation
 - 3 pockets and 2" silver reflective tape



391-EZ275
 - Durable, comfortable stretch material
 - Light abrasion protection
 - UPF 40+
 - Soak sleeves in cool water and snap or wave in the air to activate

COMBINATION PHASE CHANGE & EVAPORATIVE Cooling Vest



Evaporative Cooling Vests

STYLE	COOLING TYPE	ACTIVATION TIME	OUTER FABRIC	INNER FABRIC	WEIGHT	CLOSURE	COLOR	SIZE
390-EZ100	Evaporative Cooling	1-2 Minutes	Polyester	HyperKewl™ Plus / Nylon	1.5 lbs	Zipper	Hi-Vis Yellow	S-3X
390-EZ150	Evaporative Cooling	1-2 Minutes	Polyester / Spandex	HyperKewl™ Plus / Nylon	0.75 lbs	Zipper	Black with Blue Trim	S-3X
390-EZ202	Evaporative Cooling	1-2 Minutes	Polyester	HyperKewl™ Plus / Nylon	1.5 lbs	Hook and Loop	Hi-Vis Yellow	S/M, L/XL, 2X/3X, 4X/5X

Evaporative Cooling Sleeves

STYLE	COOLING TYPE	ACTIVATION TIME	OUTER FABRIC	INNER FABRIC	WEIGHT	CLOSURE	COLOR	SIZE
391-EZ275BK	Evaporative Cooling	30 Seconds	Nylon / Spandex	Brushed Inner	-	Elastic	Black	M/L, XL/2X
391-EZ275LY	Evaporative Cooling	30 Seconds	Nylon / Spandex	Brushed Inner	-	Elastic	Lime Yellow	M/L, XL/2X

Combination Phase Change & Evaporative Cooling Vest

STYLE	COOLING TYPE	ACTIVATION TIME	OUTER FABRIC	INNER FABRIC	WEIGHT	CLOSURE	COLOR	SIZE
390-EZHPC	Phase Change & Evaporative	45 minutes	Nylon	Hyperkewl Plus/Nylon	-	Zipper	Red with Black	M-3XL



Cooling Towels & Neck Wraps

LONG-LASTING COOLING AND
MOISTURE WICKING



Scan it



UV PROTECTION

EZ-COOL[®] MAX COOLING TOWEL 396-EZ900

- Microfiber Cooling Towel - Container with Clip included
- Naturally absorbs sweat and provides UV protection



EZ-COOL[®] PVA COOLING TOWEL 396-602

- Advanced Poly Vinyl Alcohol (PVA) material absorbs water and sweat efficiently and remains active for hours



EZ-COOL[®] PVA COOLING NECK WRAP 393-650

- Rinse prior to use and wrap around the neck for an exceptional cooling effect

SUPER ABSORBENT AND SUPER COOL

EZ-COOL[®] Max Cooling Towel

STYLE	COOLING TYPE	ACTIVATION TIME	OUTER FABRIC	COLOR	SIZE
396-EZ900-NV	Evaporative Cooling	30 seconds	Polyester Hollow Fiber Blend / Nylon	Navy	12" X 36"
396-EZ900-LY	Evaporative Cooling	30 seconds	Polyester Hollow Fiber Blend / Nylon	Hi-Vis Lime	12" X 36"
396-EZ900-PK	Evaporative Cooling	30 seconds	Polyester Hollow Fiber Blend / Nylon	Pink	12" X 36"
396-EZ900-GC	Evaporative Cooling	30 seconds	Polyester Hollow Fiber Blend / Nylon	Digital Camo	12" X 36"
396-EZ900-NV-BULK	Evaporative Cooling	30 seconds	Polyester Hollow Fiber Blend / Nylon	Navy	12" X 36"
396-EZ900-LY-BULK	Evaporative Cooling	30 seconds	Polyester Hollow Fiber Blend / Nylon	Hi-Vis Lime	12" X 36"

EZ-COOL[®] PVA Cooling Towel

STYLE	COOLING TYPE	ACTIVATION TIME	OUTER FABRIC	COLOR	SIZE
396-602-B	Evaporative Cooling	30 seconds	PVA Cooling Towel	Blue	13" x 31"
396-602-L	Evaporative Cooling	30 seconds	PVA Cooling Towel	Hi-Vis Lime	13" x 31"
396-602-P	Evaporative Cooling	30 seconds	PVA Cooling Towel	Pink	13" x 31"
396-602-B-BULK	Evaporative Cooling	30 seconds	PVA Cooling Towel	Blue	13" x 31"

EZ-COOL[®] PVA Cooling Neck Wrap

STYLE	COOLING TYPE	ACTIVATION TIME	OUTER FABRIC	COLOR	SIZE
393-650-B	Evaporative Cooling	30 seconds	PVA Cooling Neck Wrap	Blue	4" x 30"
393-650-L	Evaporative Cooling	30 seconds	PVA Cooling Neck Wrap	Hi-Vis Lime	4" x 30"
393-650-P	Evaporative Cooling	30 seconds	PVA Cooling Neck Wrap	Pink	4" x 30"



Evaporative Cooling Hats



EZ-COOL' COOLING TIE HAT
396-EZ205

- 100% Polyester cool mesh
- Tie fasten in back for comfortable fit
- 5-10 hours of cooling relief



EZ-COOL' COOLING RANGER HAT
396-EZ450

- Comfortable quilted cotton outer shell with inner HyperKewl™ cooling fabric and water repellent nylon liner
- 5-10 hours of cooling relief



EZ-COOL' COOLING FR BEANIE
396-EZFR350

- Fire Resistant 88/12 cotton nylon Banwear outer shell
- Soak 1-2 minutes for 5-10 hours of cooling relief
- Lightweight and durable



VALUE COOLING TIE HAT
396-300

- Cooling properties can be reactivated for the life of the product
- Extended cooling lasts all day



VALUE COOLING RANGER HAT
396-425-KHK

- Extended neck shade to block sun
- Extended cooling lasts 1 to 7 days depending upon ambient conditions

**FAST
ACTIVATING
COOLING
FABRIC**

Evaporative Cooling Hats

STYLE	COOLING TYPE	ACTIVATION TIME	OUTER FABRIC	INNER FABRIC	CLOSURE	COLOR	SIZE
396-EZ205-BLU	Evaporative Cooling	1-2 Minutes	Polyester Mesh	HyperKewl™	Tie	Blue	OS
396-EZ450-LY	Evaporative Cooling	1-2 Minutes	Cotton	HyperKewl™	Drawstring	Hi-Vis Yellow	Dual, S/M-2X/3K
396-EZ450-KHK	Evaporative Cooling	1-2 Minutes	Cotton	HyperKewl™	Drawstring	Khaki	Dual, S/M-2X/3K
396-EZFR350	Evaporative Cooling	1-2 Minutes	Banwear FR Cotton	Waterproof Nylon	Elastic	Orange	OS
396-300-CBL	Evaporative Cooling	20-30 Minutes	Poly / Cotton	Cooling Crystals	Tie	Cowboy Blue	OS
396-300-NAV	Evaporative Cooling	20-30 Minutes	Poly / Cotton	Cooling Crystals	Tie	Navy	OS
396-300-PAT	Evaporative Cooling	20-30 Minutes	Poly / Cotton	Cooling Crystals	Tie	Patriotic Flag	OS
396-425-KHK	Evaporative Cooling	20-30 Minutes	Poly / Cotton	Cooling Crystals	Elastic	Khaki	OS



Neck Shades and Pads



396-EZ810

Lightweight and durable material absorbs, stores and releases water within a multi-layered fabric



396-EZFR811

Durable flame-resistant Banwear cotton outer shell combines cooling comfort and protection from the sun



396-405-BLU

Polyester and cotton blend fabric with cooling crystals at crown, securely attaches into hard hats



396-400-BLU

Extended cooling last several hours depending upon ambient conditions

Cooling Bandanas



EZ-COOL® COOLING BANDANA 393-EZ201

- Lightweight, comfortable fabric
- Outer fabric will be dry while the internal cooling fabric provides cooling for up to 8 hours



VALUE COOLING BANDANA 393-100

- Extended cooling lasts several hours
- Cooling properties can be reactivated by soaking in water, for the life of the product

Neck Shades and Cooling Hard Hat Pads

STYLE	COOLING TYPE	ACTIVATION TIME	OUTER FABRIC	INNER FABRIC	CLOSURE	COLOR	SIZE
396-EZ810	Evaporative Cooling	1-2 Minutes	Polyester	HyperKewl™ Plus / Nylon	Hook & Loop	Hi-Vis Yellow	OS
396-EZFR811	Evaporative Cooling	1-2 Minutes	FR Cotton Banox	HyperKewl™ Plus / Nylon	Hook & Loop	Navy	OS
396-405-BLU	Evaporative Cooling	20-30 Minutes	Poly / Cotton	Cooling Crystals	Hook & Loop	Blue	OS
396-400-BLU	Evaporative Cooling	20-30 Minutes	Poly / Cotton	Cooling Crystals	Hook & Loop	Blue	OS

Cooling Bandanas

393-EZ201-NVY	Evaporative Cooling	1-2 Minutes	Polyester / Mesh	HyperKewl™	Tie / Breakaway Snap	Navy	2" x 35"
393-EZ201-PAT	Evaporative Cooling	1-2 Minutes	Polyester / Mesh	HyperKewl™	Tie / Breakaway Snap	Patriotic Flag	2" x 35"
393-EZ201-KHK	Evaporative Cooling	1-2 Minutes	Polyester / Mesh	HyperKewl™	Tie / Breakaway Snap	Khaki	2" x 35"
393-100-BLU	Evaporative Cooling	20-30 Minutes	Poly / Cotton	Cooling Crystals	Tie	Blue	2" x 35"
393-100-DGC	Evaporative Cooling	20-30 Minutes	Poly / Cotton	Cooling Crystals	Tie	Digital Camo	2" x 35"
393-100-CBL	Evaporative Cooling	20-30 Minutes	Poly / Cotton	Cooling Crystals	Tie	Cowboy Blue	2" x 35"
393-100-CRD	Evaporative Cooling	20-30 Minutes	Poly / Cotton	Cooling Crystals	Tie	Cowboy Red	2" x 35"
393-100-NAVY	Evaporative Cooling	20-30 Minutes	Poly / Cotton	Cooling Crystals	Tie	Navy	2" x 35"
393-100-PAT	Evaporative Cooling	20-30 Minutes	Poly / Cotton	Cooling Crystals	Tie	Patriotic Flag	2" x 35"
393-100-KHK	Evaporative Cooling	20-30 Minutes	Poly / Cotton	Cooling Crystals	Tie	Khaki	2" x 35"



Scan it

PIP CLIMA BAND™

PROTECTION IN ANY CLIMATE

- > Seamless stretch construction
- > Quick-dry, sweat absorbing fabric
- > Anti-odor technology
- > Resists UV rays
- > Blocks wind, sun & dust



VERSATILE Wear it multiple ways

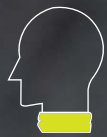

NECKERCHIEF



HEADBAND



CAP



DO RAG



SCARF



BALACLAVA



HAIRBAND



WRISTBAND



EZ-COOL® DISPOSABLE SWEATBANDS

396-500 | 396-505

- Soft absorbent polyporous constructed from hydrophilic fibers woven into a fibrous batting
- Polyporous does not require water activation



ABSORPTIVE
COOLING TECHNOLOGY

HARD HAT TERRY SWEATBAND

396-20870

- Attaches to hard hat suspension with snaps
- Soft terry cloth fabric helps absorb sweat at forehead

CLIMA BAND™

STYLE	COOLING TYPE	OUTER FABRIC	CLOSURE	COLOR	SIZE
393-200-CWB	Absorptive Cooling	Nylon / Polyester	-	Cowboy Blue	10" x 20"
393-200-YEL	Absorptive Cooling	Nylon / Polyester	-	Hi-Vis Yellow	10" x 20"
395-250FR-B	Absorptive Cooling	Meta-Aramid/Lenzing FR	-	Black	10" x 20"
393-EZ310-YEL	Evaporative Cooling	Polyester/Polypro	Cordlock	Hi-Vis Yellow	10" x 10"
393-EZ310-BLK	Evaporative Cooling	Polyester/Polypro	Cordlock	Black	10" x 10"
Cooling Sweatbands					
396-500	Absorptive Cooling	100% Cellulose	Elastic	Blue	OS
396-505	Absorptive Cooling	100% Polyester Non-Woven	Elastic	Teal	OS
396-20870-BGE	Absorptive Cooling	Cotton / Terry Cloth	Snaps	Beige	OS
396-20870-NAV	Absorptive Cooling	Cotton / Terry Cloth	Snaps	Navy	OS



Block Harmful Sun Rays



HI-VIS FULL-COVERAGE VISOR
396-850

- Extended visor at front to block sun from worker's eyes
- Fits most cap style and full brim hard hats



HARD HAT VISOR WITH NECK SHADE
396-800-YEL

- Fits most cap style and full brim hard hats
- Shields eyes and neck from the sun



FR TREATED HI-VIS VISOR
396-801FR-YEL

- FR treated up to 25 washes
- Fits most cap style and full brim hard hats



FR TREATED HI-VIS NECK SHADE
396-700FR

- FR treated up to 25 washes
- Elastic at back for secure fit
- Fits most cap style and full brim hard hats



HI-VISIBILITY RANGER HAT
350-RANGER

- Hi-Visibility ranger style hat with silver reflective tape
- Full brim lightweight hat with mesh crown

Full brim lightweight shade hat with mesh crown keeps head ventilated and cool

Hard Hat Visors/Neck Shades

STYLE	COOLING TYPE	OUTER FABRIC	MATERIAL TYPE	CLOSURE	COLOR	SIZE
396-850-LY 396-850-OR	Shading	Hi-Vis Full-Coverage Hard Hat Visor with Neck Shade	Mesh / Solid	Elastic	■ Hi-Vis Yellow ■ Hi-Vis Orange	OS
396-800-YEL	Shading	ANSI Compliant Polyester Hi-Vis with Reflective Tape	Solid	Elastic	■ Hi-Vis Yellow	OS
396-801FR-YEL	Shading	ANSI Compliant Polyester FR Treated Hi-Vis with Reflective Tape	Mesh / Solid	Elastic	■ Hi-Vis Yellow	OS
396-700FR-YEL 396-700FR-OR	Shading	ANSI Compliant Polyester FR Treated Hi-Vis with Reflective Tape	Mesh / Solid	Elastic	■ Hi-Vis Yellow ■ Hi-Vis Orange	OS
396-851FR-LY 396-851FR-OR	Shading	ANSI Compliant Polyester FR Treated Hi-Vis with Reflective Tape	Mesh / Solid	Elastic	■ Hi-Vis Yellow ■ Hi-Vis Orange	OS
Hi Visibility Ranger Hat						
350-RANGER	Shading	ANSI Compliant Polyester Hi-Vis with Reflective Tape	Mesh / Solid	Drawstring	■ Hi-Vis Yellow	OS

SECTION:

Emergency Beacons



This section contains warning beacons that are designed to provide instant visibility where needed, calling attention to anyone in their vicinity. Their design and brightness combined with the different colors and accessory items make warning beacons infinitely versatile to reduce potentially serious and otherwise avoidable injuries.

EFLARE™ WARNING BEACON LIGHT BEAM PROFILE

Eflare™ Warning Beacons are designed to deliver the most intense part of the light beam in a range of 0-5° above horizontal, with a peak near 3°. Due to this beam profile, these beacons will not impede the vision of users at a short range unless it's positioned at eye level.

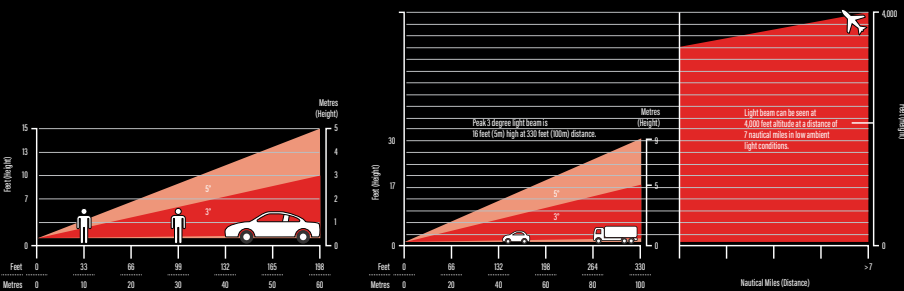

Warning Beacons featured in this section utilize LED technology to produce an intensely bright display and project an angle that will not dazzle or impede the vision of drivers. Stand-alone units and units compatible with safety triangles are available.



ROAD CLOSURES



OBSTRUCTIONS



SPILLS



LOADING/UNLOADING ZONES



Scan it



Warning Beacons

Police / Fire / Utilities / Rail & Port / Warehouses Factories / Technical Rescue / Hazmat Accredited For Use In Class 1, Division 2 / Zone 2 Hazardous Areas



▲ 939-AT290-A

Patented Fresnel lens and high-luminosity LEDs allow beam to be visible for ¾ mile

Reflective strip and fluorescent body for maximum visibility

Impact-resistant ABS body



▲ 939-AT293-R/B

Shatterproof polycarbonate lens

Improved switching mechanism involves a simple twist of the lens to the desired function

High-strength clips with added holes enable attachment versatility

Intensely bright, durable, lightweight, easy to use, versatile and safer for the environment

Eflare™ Safety & Emergency Beacons

ITEM NUMBER	BEACON COLOR	LIGHT INTENSITY	OPERATION	FLASH RATE	BATTERIES	HEIGHT	WEIGHT	PROP 65
939-AT290-A	Amber	8 LED	Flash or Steady-On 1-Color	165-185 fpm	Four "AA" Alkaline	8"	9.6 oz. with Batteries	▲ ^R
939-AT290-R	Red	8 LED	Flash or Steady-On 1-Color	165-185 fpm	Four "AA" Alkaline	8"	9.6 oz. with Batteries	▲ ^R
939-AT290-B	Blue	8 LED	Flash or Steady-On 1-Color	165-185 fpm	Four "AA" Alkaline	8"	9.6 oz. with Batteries	▲ ^R
939-AT290-G	Green	8 LED	Flash or Steady-On 1-Color	165-185 fpm	Four "AA" Alkaline	8"	9.6 oz. with Batteries	▲ ^R
939-AT290-W	White	8 LED	Flash or Steady-On 1-Color	165-185 fpm	Four "AA" Alkaline	8"	9.6 oz. with Batteries	▲ ^R
939-AT293-R/B	Red & Blue	4 + 4 LED	Dual Flash 2-Color	165-185 fpm	Four "AA" Alkaline	8"	9.6 oz. with Batteries	▲ ^R
939-AT293-A/W	Amber & White	4 + 4 LED	Dual Flash 2-Color	165-185 fpm	Four "AA" Alkaline	8"	9.6 oz. with Batteries	▲ ^R
939-AT293-B/W	Blue & White	4 + 4 LED	Dual Flash 2-Color	165-185 fpm	Four "AA" Alkaline	8"	9.6 oz. with Batteries	▲ ^R
939-AT293-R/A	Red & Amber	4 + 4 LED	Dual Flash 2-Color	165-185 fpm	Four "AA" Alkaline	8"	9.6 oz. with Batteries	▲ ^R
939-AT293-R/W	Red & White	4 + 4 LED	Dual Flash 2-Color	165-185 fpm	Four "AA" Alkaline	8"	9.6 oz. with Batteries	▲ ^R

C = ▲^R WARNING: Cancer - www.P65Warnings.ca.gov R = ▲^R WARNING: Reproductive Harm - www.P65Warnings.ca.gov C&R = ▲^R WARNING: Cancer and Reproductive Harm - www.P65Warnings.ca.gov

* Additional colors available upon request * Batteries not included



▲ 939-AT290-05-A/B

Helicopter Kits



INCLUDES 5 BEACONS, 5 RUBBER BASE MOUNTS, INSTRUCTION CARD AND STORAGE BAG

Eflare™ Helicopter Landing Zone Kits

ITEM NUMBER	BEACON COLOR	LIGHT INTENSITY	OPERATION	FLASH RATE	BATTERIES	HEIGHT	WEIGHT	PROP 65
939-AT290-05-A/B	4 Amber, 1 Blue	8 LED	Flash or Steady-On 1-Color	165-185 fpm	Four "AA" Alkaline	8"	9.6 oz. with Batteries (each)	▲ ^R
939-AT290-05-R/B	4 Red, 1 Blue	8 LED	Flash or Steady-On 1-Color	165-185 fpm	Four "AA" Alkaline	8"	9.6 oz. with Batteries (each)	▲ ^R
939-AT290-05-R	5 Red	4 LED	Flash or Steady-On 1-Color	165-185 fpm	Four "AA" Alkaline	6"	6.4 oz. with Batteries (each)	▲ ^R

C = ▲^R WARNING: Cancer - www.P65Warnings.ca.gov

R = ▲^R WARNING: Reproductive Harm - www.P65Warnings.ca.gov

C&R = ▲^R WARNING: Cancer and Reproductive Harm - www.P65Warnings.ca.gov



Scan it



Compact & Railroad Beacons

PROVIDING 360° VISIBILITY FOR MAXIMUM SAFETY



▲ 939-AT280-A



▲ 939-EF350-R



▲ 939-TF250-B-ASY

Blue beacon with built-in flashlight

Lanyard included

Magnetic base

Only 6" High

- > Waterproof
- > Dust Proof
- > Will survive a 3 foot drop onto a concrete surface

Eflare™ Compact Beacons

ITEM NUMBER	BEACON COLOR	LIGHT INTENSITY	OPERATION	FLASH RATE	BATTERIES	HEIGHT	WEIGHT	PROP 65
939-AT280-A	Amber	8 LED	Flash or Steady-On 1-Color	165-185 fpm	Four "AA" Alkaline	6"	9.6 oz. with Batteries	▲ ^R
939-AT280-R	Red	8 LED	Flash or Steady-On 1-Color	165-185 fpm	Four "AA" Alkaline	6"	9.6 oz. with Batteries	▲ ^R
939-AT280-B	Blue	8 LED	Flash or Steady-On 1-Color	165-185 fpm	Four "AA" Alkaline	6"	9.6 oz. with Batteries	▲ ^R
939-EF350-A	Green	8 LED	Flash 1-Color	165-185 fpm	Four "AA" Alkaline	6"	9.6 oz. with Batteries	▲ ^R
939-EF350-R	Red	4 LED	Flash 1-Color	165-185 fpm	Four "AA" Alkaline	6"	9.6 oz. with Batteries	▲ ^R

Eflare™ Railroad Beacons

939-TF250-B-ASY	Blue	4 LED	Flash 1-Color	165-185 fpm	Four "AA" Alkaline	6"	9.6 oz. with Batteries	▲ ^R
--	White	3 LED	Steady-On Flashlight	165-185 fpm	Four "AA" Alkaline	6"	9.6 oz. with Batteries	▲ ^R

C = ▲^R WARNING: Cancer - www.P65Warnings.ca.gov R = ▲^R WARNING: Reproductive Harm - www.P65Warnings.ca.gov C&R = ▲^R WARNING: Cancer and Reproductive Harm - www.P65Warnings.ca.gov

Safety Triangle



MOUNTS INSIDE MOST ROAD TRIANGLES AT 4"



- > LED technology at 25 Candela luminous intensity. Three red LEDs flash rate of 160 fpm is visible for up to 3000 ft. away at night
- > Runs 20+ hours on a single AA alkaline battery* and includes a spare battery compartment
- > Compact and stores easily in glove box

Eflare™ Safety Triangle Beacon

ITEM NUMBER	BEACON COLOR	LIGHT INTENSITY	OPERATION	FLASH RATE	BATTERIES	HEIGHT	WEIGHT	PROP 65
939-TB10-R	Red	3 LED	Flash 1-Color	160 fpm	1 "AA" Alkaline	4"	3.5 oz. without Battery	▲ ^R



C = ▲^R WARNING: Cancer - www.P65Warnings.ca.gov
R = ▲^R WARNING: Reproductive Harm - www.P65Warnings.ca.gov
C&R = ▲^R WARNING: Cancer and Reproductive Harm - www.P65Warnings.ca.gov



Scan it



Accessories

PROVIDING HANDS-FREE VISIBILITY AND TRANSPORT PROTECTION



▲ 939-EFBASE



▲ 939-EFAVBASE



▲ 939-EFMAGBASE

Clips and base mounts provide vertical, hands-free positioning



▲ 939-EFMAGCLIP



▲ 939-EFCLIP



▲ 939-EFBAG4

Eflare™ Warning Beacon Accessories

STYLE NUMBER	DESCRIPTION	FEATURE	PROP 65
939-EFBASE	Rubber Base Mount	General purpose base that	▲ R
939-EFAVBASE	Aviation Rubber Base Mount	Secure base for special purposes	▲ R
939-EMAGBASE	Magnetic Base Mount	Rated up to 50 mph when securely mounted to vehicle	▲ R
939-EMAGCLIP	Magnetic Mounting Clip	For stationary objects	▲ R
939-EFCLIP	Cone Mounting Clip	Enables verticle mounting on most types of cones	▲ R
939-EFBAG-4	Large Storage Bag	Carry bag for 4-6 beacons plus accessories	▲ R

C = ▲ WARNING: Cancer - www.P65Warnings.ca.gov R = ▲ WARNING: Reproductive Harm - www.P65Warnings.ca.gov C&R = ▲ WARNING: Cancer and Reproductive Harm - www.P65Warnings.ca.gov

Batons

Police / Fire / Airport /
Traffic Control /
Construction / Public Safety



▲ 935-004
4 LED Light Intensity



▲ 935-006B
6 LED Light Intensity



Hand-held visibility assists in identifying hazardous conditions and dangerous areas

Flash Batons

STYLE NUMBER	COLOR	LIGHT INTENSITY	OPERATION	FEATURE	BATTERIES	LENGTH	DIAMETER	PACKAGING	PROP 65
935-004	Red	4 LED	Flash, Steady-On, Off	-	Two "C"	16"	1.25"	Individually Boxed	▲ C&R
935-006B	Red	6 LED	Flash, Steady-On, Off	Audible Alarm Button (approx. 110 dB)	Three "C"	22"	1.25"	Individually Boxed	▲ C&R

C = ▲ WARNING: Cancer - www.P65Warnings.ca.gov R = ▲ WARNING: Reproductive Harm - www.P65Warnings.ca.gov C&R = ▲ WARNING: Cancer and Reproductive Harm - www.P65Warnings.ca.gov

* Batteries not included

SECTION:

First Aid Kits



This section features first aid kits that meet the ANSI Z308.1-2015 performance standard. This standard establishes minimum performance requirements for first aid kits and their supplies. First aid kits are classified based on the assortment and quantity of first aid supplies intended to deal with most types of injuries that may be encountered in the workplace. These may include major and minor wounds, minor burns, sprains and strains and eye injuries. As each work environment is unique, it is expected that the contents of each kit will be supplemented as needed based upon the recommendations of a person competent in first aid.

For the workplace, OSHA 29 CFR 1910.151(b) requires that "Adequate first aid supplies shall be readily available." This rule applies to treatment of minor injuries that occur in the workplace. OSHA refers employers to ANSI Z308.1-2015 for guidance on minimum requirements for first aid kits. PIP® also offers an economy line for hobbyist and personal use.



STANDARDS

Class A First Aid Kits are designed to address the most common types of workplace injuries such as minor cuts and abrasions, burns and eye injuries.

Class B First Aid Kits offer a broader range of supplies for injuries that can occur in high-risk environments, such as severe lacerations, or bone fractures or breaks.

Types of First Aid Kits refer to the container characteristics:

- > Type I – Wall-mountable, for indoor use
- > Type II – Portable, for indoor use
- > Type III – Mountable, water-resistant and for indoor/outdoor use
- > Type IV – Waterproof, both portable and mountable

Kits are kept compliant when maintained and stocked to the specifications of the ANSI Z308.1-2015 standard. PIP® offers all-in-one refill packs to replace the components of each original first aid kit so compliance is never an issue.

Kit requirements may vary by state.



CUTS AND ABRASIONS



BURNS



EYE INJURIES



BONE FRACTURES OR BREAKS



SEVERE LACERATIONS



Scan it

CLASS A AND CLASS B First Aid Kits

MEETING ANSI Z308.1-2015



- > Class A and Class B kit solutions to fulfill all first aid needs
- > All-in-one refill pack replaces the components of the first aid kit all at once, in a clear pouch where the contents are easy to see
- > Assembled in the USA



PIP® First Aid Kits provide an upgrade to the ANSI Z30.1-2015 standard.



WATERPROOF GASKET
keeps kit contents dry



METAL CONSTRUCTION
maximum kit durability

WATERPROOF & DURABLE

The new lightweight First Aid Kits, item no. 299-15025A, 299-15050A are designed with waterproof gasket, protecting the contents from getting wet. The metal construction of item no. 299-15025A-M, 299-15050A-M, 299-15050B-M First Aid Kits provide durability and maximum performance.

THE PIP® ADVANTAGE: A UNIQUE REFILL SYSTEM

100% COMPLIANCE

Replace the parts of the first aid kit all at once, in a clear pouch where the contents are easy to see. No need to spend more money on a new case.



PIP'S ALL-IN-ONE REFILL PACK
Organized in a clear pouch, the contents are easy to see



THE COMPETITION
Disorganized and difficult to sort through

CLASS A KITS

PIP® Class A kits have contents designed to deal with the most common types of workplace injuries.

CLASS B KITS

PIP® Class B kits offer a broader range and quality of supplies to deal with injuries in more complex or high-risk environments like injuries requiring burn dressings, splints or tourniquets.

Kit requirements may vary by state.

STYLE NUMBER	STANDARDS MET	TREATMENTS	PACKAGING	MOUNT
ANSI Class A First Aid Kits				
299-15025A	ANSI Z308.1-2015	25 person	Weatherproof plastic box	Wall mountable via slots in carrying handle
299-15025A-M	ANSI Z308.1-2015	25 person	Metal box	Wall mountable via slots in carrying handle
299-15025A-RP	Refill pack for 299-1025A and 299-1025A-M			
299-15050A	ANSI Z308.1-2015	50 person	Weatherproof plastic box	Wall mountable via slots in carrying handle
299-15050A-M	ANSI Z308.1-2015	50 person	Metal box	Wall mountable via slots in carrying handle
299-15050A-RP	Refill pack for 299-1050A and 299-1050A-M			
ANSI Class B First Aid Kits				
299-15050B-M	ANSI Z308.1-2015	50 person	Metal box	Wall mountable via slots in carrying handle
299-15050B-RP	Refill pack for 299-1050A and 299-1050A-M			



PERSONAL & CONSTRUCTION KITS

Non-ANSI first aid kits available for hobbyist and personal use



SUPPLIES INCLUDED

STYLE	299-13210	299-13290
ABDOMINAL PAD (5" x 9")	1	1
ALCOHOL PREP PADS	-	20*
ANTISEPTIC TOWELETTES	12*	-
HAND SANITIZER	1	-
COLD INSTANT PACK (4" x 5")	1	1
CONFORMING GAUZE ROLL (2")	-	1
FLEXIBLE FABRIC STRIPS	6	-
EYE WASH (1 OZ.)	-	1
FLEXIBLE FABRIC FINGERTIP	2	-
FLEXIBLE FABRIC KNUCKLE	2	-
FIRST AID & BURN CREAM	8*	8*
GAUZE PADS (3" x 3")	4	-
MICROBIAL TOWELETTES	1	-
MEDICAL EXAM GLOVES	2	1
CLEAR ADHESIVE STRIPS	16*	100*
ELASTIC BANDAGE (2")	1	-
ASSORTED SAFETY PINS	4	-
SCISSORS (4")	1	1
SPLINTER FORCEPS	1	1
ADHESIVE TAPE (1/2")	1	1
TRIANGLE BANDAGE	1	1
CLEANSING TOWELETTES	6	-



Personal First Aid Kit
299-13210

- Variety of different items to treat minor injuries



Contractor First Aid Kit
299-13290

- Fewer items in bulk quantities to treat minor injuries

BLOODBORNE PATHOGENS KIT



Bloodborne Pathogens Kit
299-13215

- Biohazard kit for bodily fluid cleanup

SUPPLIES INCLUDED

FACE SHIELD & VISOR	1
ABSORBENT TOWELS	3
APRON	1
ANTI-MICROBIAL TOWELETTE	1
MEDICAL EXAM GLOVES	2
BIO SCOOP & SCRAPPER	1
BIOHAZARD WASTE BAGS	2
RED SUPER ABSORB FOAM (10G)	1
ANTISEPTIC TOWELETTES (XL)	2
INCIDENT REPORT	1 Exposure Control Report Form

IDEAL FOR:

- > Hobbyists
- > Personal Use

STYLE NUMBER	STANDARDS MET	PACKAGING	MOUNT
Personal First Aid Kit			
299-13210	---	Weatherproof plastic box	Wall mountable via slots in carrying handle
Contractor First Aid Kit			
299-13290	---	Weatherproof plastic box	Wall mountable via slots in carrying handle
Bloodborne Pathogens Kit			
299-13215	OSHA 1910.103	Weatherproof plastic box	Wall mountable via slots in carrying handle

SECTION:

Ergonomics



This section contains important PPE related to Ergonomics. Lifting, bending and performing repetitive motions can take a toll on the body, not only for workers who have been on the job for years, but also younger workers who may overexert themselves. Ergonomic products can provide extra support and help reduce stress on the back, knees, elbows and wrists.

PIP® Ergonomic products can be worn proactively to help provide a more comfortable work experience and reduce the wear and tear a job can take on the body.

PRODUCTS

Wrist & Elbow Supports

Reduce stress and provide stability

Knee Sleeves

Additional reinforcement for muscles and tissues

Knee Pads

Perform a similar job as the meniscus, acting as shock absorbers between the knee and hard surfaces

Back Supports

Reinforce the lumbar area and provide stability for the worker, especially when lifting



MUSCLE EXERTION



REPETITIVE TASKS



AWKWARD POSTURES



VIBRATION



Scan it

Wrist and Elbow Supports



STRETCHABLE WRIST SUPPORT

290-9010BLK

- Stretchable elastic fabric
- For use in office / retail / light industrial applications



ELASTIC WRIST WRAP

290-9011BLK

- Thumb loop holds support in place
- For use in office / retail / light industrial applications



SINGLE WRAP WRIST SUPPORT

290-9013

- Helps maintain a neutral wrist position
- For use in office / retail / light industrial applications



LIGHT NEOPRENE WRIST SUPPORT

290-9015

- Light neoprene body provides soothing warmth
- For use in office / retail / light industrial applications



ELBOW WRAP

290-9000

- Provides relief from muscle stress and pressure caused by repetitive motion
- For use in office / retail / light industrial applications



ELBOW SLEEVE

290-9001

- Provides therapeutic warming to reduce stress and comfort muscles
- For use in office / retail / light industrial applications

Wrist & Elbow Supports

STYLE	SUPPORT TYPE	FABRIC	THUMB LOOP	CLOSURE	SUPPORT STAYS	COLOR	SIZE	DIMENSIONS	PACKAGING	STOCK TYPE
290-9010BGE	Stretchable Wrist Support	Nylon Spandex	No	Hook and Loop	No	Beige	OS	---	1 per Poly Bag	Stock
290-9010BLK	Stretchable Wrist Support	Spandex Polyester	Yes	Hook and Loop	No	Black	OS	---	1 per Poly Bag	Stock
290-9011BLK	Elastic Wrist Wrap with Thumb Loop	Spandex Polyester	Yes	Hook and Loop	No	Black	OS	---	1 per Poly Bag	Stock
290-9013S	Single Wrap Ambidextrous Wrist Support	Nylon Neoprene	Yes	Hook and Loop	Yes	Black	S	5.375" - 6.125"	1 per Poly Bag	Stock
290-9013M	Single Wrap Ambidextrous Wrist Support	Nylon Neoprene	Yes	Hook and Loop	Yes	Black	M	6.125" - 6.875"	1 per Poly Bag	Stock
290-9013L	Single Wrap Ambidextrous Wrist Support	Nylon Neoprene	Yes	Hook and Loop	Yes	Black	L	6.875" - 7.625"	1 per Poly Bag	Stock
290-9013XL	Single Wrap Ambidextrous Wrist Support	Nylon Neoprene	Yes	Hook and Loop	Yes	Black	XL	7.625" - 8.375"	1 per Poly Bag	Stock
290-9015	Light Neoprene Wrist Support	Nylon Neoprene	Yes	Hook and Loop	No	Black	OS	---	1 per Poly Bag	Stock
290-9000S	Elbow Support Wrap	Nylon Neoprene	-	Hook and Loop	-	Black	S	8.5" - 10"	1 per Poly Bag	Stock
290-9000M	Elbow Support Wrap	Nylon Neoprene	-	Hook and Loop	-	Black	M	10" - 11"	1 per Poly Bag	Stock
290-9000L	Elbow Support Wrap	Nylon Neoprene	-	Hook and Loop	-	Black	L	11" - 12"	1 per Poly Bag	Stock
290-9000XL	Elbow Support Wrap	Nylon Neoprene	-	Hook and Loop	-	Black	XL	12" - 13.5"	1 per Poly Bag	Stock
290-9001S	Elbow Sleeve	Nylon Neoprene	-	Sleeve	-	Black	S	8.5" - 10"	1 per Poly Bag	Stock
290-9001M	Elbow Sleeve	Nylon Neoprene	-	Sleeve	-	Black	M	10" - 11"	1 per Poly Bag	Stock
290-9001L	Elbow Sleeve	Nylon Neoprene	-	Sleeve	-	Black	L	11" - 12"	1 per Poly Bag	Stock
290-9001XL	Elbow Sleeve	Nylon Neoprene	-	Sleeve	-	Black	XL	12" - 13.5"	1 per Poly Bag	Stock



Knee Pads And Sleeves

Scan it

REDUCE INJURIES AND INCREASE PRODUCTIVITY

PREVENT & PROTECT



HARD PLASTIC CAP KNEE PADS

291-100

- Abrasion-resistant and great for pivoting
- Thick foam center padding
- Durable lightweight pads that deliver all-day comfort



NON-MARRING KNEE PADS

291-110

- Ergonomically designed to flex with knee movement
- Extended rubber-like PVC cap won't mar, scratch or scuff surfaces



CLEAR FLAT CAP GEL KNEE PADS

291-130

- Air-injected gel pads are ideal for work on hard surfaces
- Flat kneeling surface prevents rocking to minimize fatigue



TERRY LINED KNEE SLEEVE

290-9020

- Terry-lined vented neoprene with nylon outer shell
- Additional neoprene panel surrounds patella

Knee Pads

STYLE	KEY FEATURE	APPLICATIONS	SUPPORT TYPE	KNEE CAP	ANTI-SLIP RIDGES	CLOSURE	COLOR	SIZE	STOCK TYPE	PACKAGING
291-100	Economical with Abrasion resistance & Great for Pivoting	Industrial / Construction	Hard Plastic Cap Knee Pads	Polyethylene	No	Hook and Loop	Gray Cap on Black	OS	Stock	1 per Poly Bag
291-110	PVC Cap Won't Mark, Scratch or Scuff Surfaces	Industrial / Construction	Non-Marring Knee Pads	Extended PVC	Yes	Hook and Loop	White Cap on Black	OS	Stock	1 per Poly Bag
291-130	Air-Injected Gel Pads are Ideal for Hard Surfaces	Industrial / Construction	Clear Flat Cap Gel Knee Pads	PVC with Flat Surface	Yes	Hook and Loop	Clear Cap on Black	OS	Stock	1 per Poly Bag

Knee Sleeves

STYLE	KEY FEATURE	COLOR	SIZE	DIMENSIONS	STOCK TYPE
290-9020	Supports muscles and tissues after suffering minor strains, sprains, injuries and arthritis	Black	S	13" - 14"	Stock
290-9020M		Black	M	14" - 15"	Stock
290-9020L		Black	L	15" - 17"	Stock
290-9020XL		Black	XL	17" - 18"	Stock



Scan it



Back Supports

REDUCE THE CHANCE OF COSTLY BACK INJURIES & LOST WORK DAYS



MESH BACK SUPPORT BELT

290-440
- Popular & economic design



HI-VIS SUPPORT BELT

290-550
- Bright hi-vis lime yellow side bands & suspenders

Proactively
help reduce
stress and limit
discomfort

APPLICATIONS



WAREHOUSE PERSONNEL



CONSTRUCTION WORKERS

Back Supports

STYLE	SUPPORT TYPE	KEY FEATURE	APPLICATIONS	BELT MATERIAL	BACK STAYS	FASTENER	SUSPENDERS	PACKAGING	COLOR	SIZE	STOCK TYPE
290-440S	Black Mesh Back Support Belt	Popular & Economic Design	Warehouse / Construction	9" Wide Nylon Mesh	5	Hook & Loop Closure on Front Panels	Adjustable & Detachable	1 per Poly Bag	Black	32"- 36"	Stock
290-440M	Black Mesh Back Support Belt	Popular & Economic Design	Warehouse / Construction	9" Wide Nylon Mesh	5	Hook & Loop Closure on Front Panels	Adjustable & Detachable	1 per Poly Bag	Black	36"- 40"	Stock
290-440L	Black Mesh Back Support Belt	Popular & Economic Design	Warehouse / Construction	9" Wide Nylon Mesh	5	Hook & Loop Closure on Front Panels	Adjustable & Detachable	1 per Poly Bag	Black	40"- 44"	Stock
290-440XL	Black Mesh Back Support Belt	Popular & Economic Design	Warehouse / Construction	9" Wide Nylon Mesh	5	Hook & Loop Closure on Front Panels	Adjustable & Detachable	1 per Poly Bag	Black	44"- 48"	Stock
290-440XXL	Black Mesh Back Support Belt	Popular & Economic Design	Warehouse / Construction	9" Wide Nylon Mesh	5	Hook & Loop Closure on Front Panels	Adjustable & Detachable	1 per Poly Bag	Black	48"- 54"	Stock
290-550M	Hi-Vis Lime Yellow Back Support Belt	Bright Hi-Vis Side Bands & Suspenders	Warehouse / Construction	8" Wide Nylon Elastic	5	Hook & Loop Closure on Front Panels	Adjustable & Detachable	1 per Poly Bag	Hi-Vis Lime Yellow	36"- 40"	Stock
290-550L	Hi-Vis Lime Yellow Back Support Belt	Bright Hi-Vis Side Bands & Suspenders	Warehouse / Construction	8" Wide Nylon Elastic	5	Hook & Loop Closure on Front Panels	Adjustable & Detachable	1 per Poly Bag	Hi-Vis Lime Yellow	40"- 44"	Stock
290-550XL	Hi-Vis Lime Yellow Back Support Belt	Bright Hi-Vis Side Bands & Suspenders	Warehouse / Construction	8" Wide Nylon Elastic	5	Hook & Loop Closure on Front Panels	Adjustable & Detachable	1 per Poly Bag	Hi-Vis Lime Yellow	44"- 48"	Stock
290-550XXL	Hi-Vis Lime Yellow Back Support Belt	Bright Hi-Vis Side Bands & Suspenders	Warehouse / Construction	8" Wide Nylon Elastic	5	Hook & Loop Closure on Front Panels	Adjustable & Detachable	1 per Poly Bag	Hi-Vis Lime Yellow	48"- 54"	Stock

SECTION:

Tool Tethering



This section contains the essential items required for dropped objects prevention – durable tool tethering lanyards, tool connectors and functional tool tethering accessories specifically designed to meet the ANSI / ISEA 121-2018 Dropped Objects Standard.

Falling objects gain speed as they drop, resulting in a higher force at impact. Factor in the drop height and weight of the object and you will realize that something as small as a tape measure can cause serious injury or damage to equipment.

IT'S A LAW OF PHYSICS

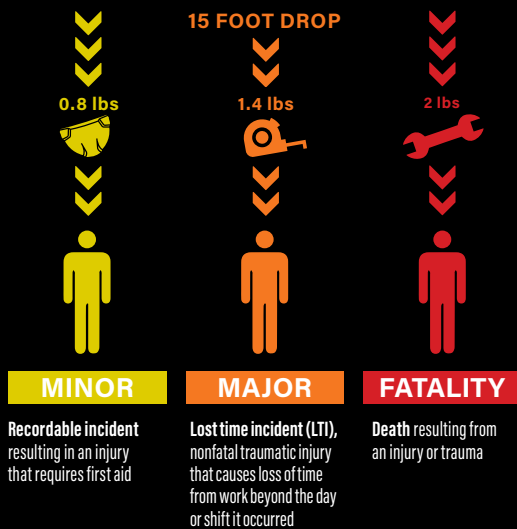

ANSI / ISEA 121:2018

ANSI / ISEA 121:2018 establishes minimum design, performance, testing and labeling requirements for safety equipment designed to reduce dropped objects incidents.

Dropped objects include hand tools, measuring instruments, small parts, structural components and other items that need to be transferred and used at heights. This standard focuses on preventative solutions actively used by workers to mitigate these hazards.

PIP® Tool Lanyards are designed to securely attach to tools to help prevent dangerous drops while providing the user with the freedom of mobility and unimpeded functionality of the tool.

PIP® Tool Connector Attachment Points and Accessories are designed to be installed onto tools or equipment to provide appropriate connection points for tethering.



FALLING OBJECTS



STRUCK OBJECT



WORKING AT HEIGHT



Scan it

Lanyards with Barrel-Lock Carabiner

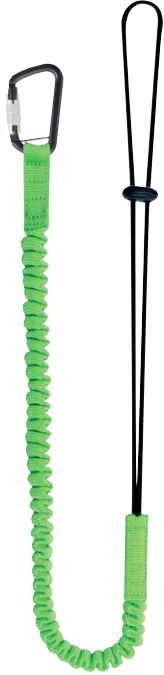

Maximum Load Limit
10 lbs.
4.5 kg

533-100011

- Snag-resistant D-frame barrel-lock carabiner with angled gate
- Lock-pin on carabiner for extra security
- Shock cording inside nylon protective webbing



Maximum Load Limit
22 lbs.
9.9 kg

533-100701

- Heavy-duty barrel-lock carabiner
- Strong nylon fastener end
- Swivel head for ease of use with large heavy tools



Maximum Load Limit
10 lbs.
4.5 kg

533-100012

- Snag-resistant D-frame barrel-lock carabiner with angled gate
- Lock-pin on carabiner for extra security
- Dual loop with shock cording inside nylon protective webbing

THE PIP® DIFFERENCE

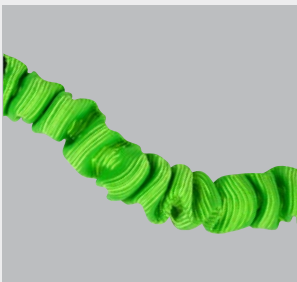

Hi-vis protective cover helps keep tether in view and provides heavy-duty protection against dirt, oil and abrasion.

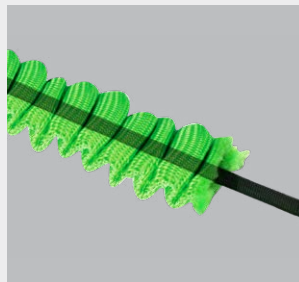

Reinforced shock cord is extra tough, providing superior protection and durability.



Designed for tools with **captive holes** or to be used in conjunction with tool tape for smaller tools.



Powder-coated quarter turn **barrel-lock carabiner** with 1" gate opening ensures a secure connection.

STYLE NUMBER	MAXIMUM LOAD LIMIT	LEG	CARABINER	GATE OPENING	FASTENER
533-100011	10 lbs / 4.5kg	Single	Barrel-lock	1" / 2.5cm	Draw string
533-100701	22 lbs / 9.9kg	Single	Barrel-lock	1" / 2.5cm	Nylon webbing
533-100012	10 lbs / 4.5kg	Double	Barrel-lock	1.5" / 3.8cm	Draw string



Connector Attachment Points

Scan it



Maximum Load Limit
3lbs.
1.4 kg

WEBBING TOOL CONNECTOR

- Premium nylon webbing
- Fully enclosed D-ring for secure attachment
- Swivel head for ease of use with small tools
- Used with tool tape as retrofit tether point for tools/equipment

533-100352 - 4.5"
533-100353 - 5.5"



Maximum Load Limit
2lbs.
0.9 kg

WIRE SLING LOOP

- Loop end to tether tools with small captive holes
- Premium coated stainless steel cable wire

533-100801

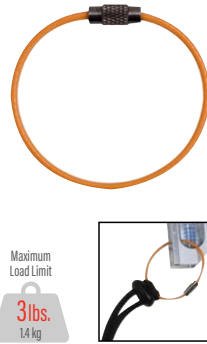

Maximum Load Limit
3lbs.
1.4 kg

WIRE SLING WITH SCREW GATE

- Screw gate end to tether tools with small captive holes
- Premium coated stainless steel cable wire

533-100802



Maximum Load Limit
15lbs.
6.8 kg

TOOL BINDING TAPE

- Premium self-adhering tape
- 12 foot roll
- Used with webbing tool connectors as retrofit tether point for tools/equipment

533-700101



Maximum Load Limit
15lbs.
6.8 kg

ELASTICATED CORD TOOL CONNECTOR

- Provides retrofit attachment point to tools/equipment
- Elastic shock cording with barrel lock to attach to tool/equipment

533-100151

Meets ANSI/ISEA 121-2018 dropped objects standard

MAKE TOOLS TETHER-READY

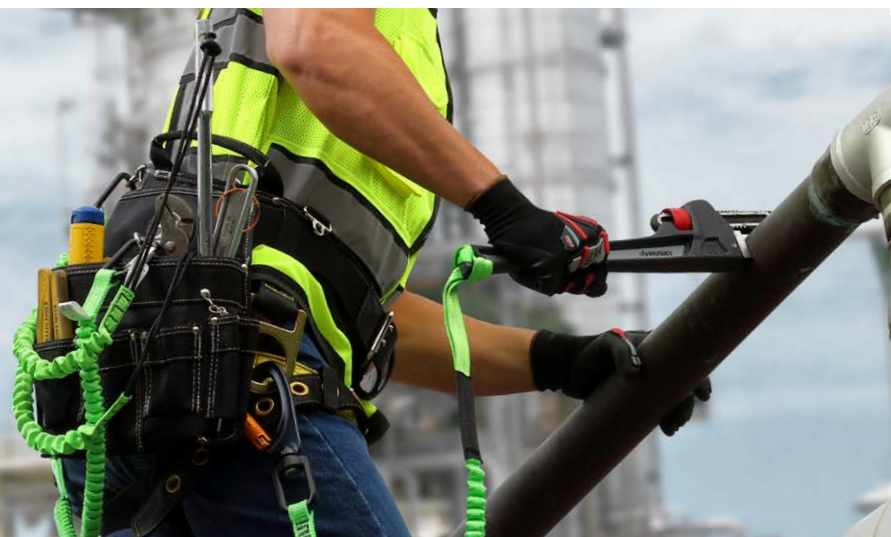

STYLE NUMBER	DESCRIPTION	MAXIMUM LOAD LIMIT
533-100352	Webbing Tool Connector - 4.5"	3lbs. / 1.4kg
533-100353	Webbing Tool Connector - 5.5"	3lbs. / 1.4kg
533-100801	Wire Sling Loop	2lbs. / 0.9kg

STYLE NUMBER	DESCRIPTION	MAXIMUM LOAD LIMIT
533-100802	Wire Sling with Screw Gate	3lbs. / 1.4kg
533-700101	Tool Binding Tape	15lbs./6.8kg
533-100151	Elasticated Cord Tool Connector	15lbs./6.8kg



Accessories

Scan it



HARD HAT LANYARD

- High-stretch elastic material
- Easy-to-attach clamp for fabric
- Tethering loop securely connects to hard hat

533-300101

Maximum Load Limit
2 lbs.
0.9 kg



MEASURING TAPE POUCH

- Used to secure most standard tape measures
- Fully enclosed D-ring for secure attachment
- Premium nylon and hook-and-loop design for strength and durability

533-300301

Maximum Load Limit
2 lbs.
0.9 kg



WRISTBAND TOOL HOLDER

- Premium nylon and elastic webbing
- Pull-on design for easy on/off application
- One size fits all

533-300401

Maximum Load Limit
2 lbs.
0.9 kg



UTILITY POUCH

- Premium nylon and elastic webbing
- Fully enclosed D-Ring for secure attachment
- Used to secure radios, cell phones and other small hand tools

533-300201

Maximum Load Limit
5 lbs.
2.3 kg



STYLE NUMBER	DESCRIPTION	MAXIMUM LOAD LIMIT
533-300101	Hard Hat Lanyard	2lbs. / 0.9kg
533-300301	Measuring Tape Pouch	2lbs. / 0.9kg

STYLE NUMBER	DESCRIPTION	MAXIMUM LOAD LIMIT
533-300401	Wristband Tool Holder	2lbs. / 0.9kg
533-300201	Utility Pouch	5lbs. / 2.3kg

Tool Tethering Kit

Be confident you have the most common tool tethering safety items you need available in one convenient kit.

STYLE NUMBER	INCLUDES
533-900101	533-100011, 533-100352, 533-700101



1 Durable Single-Leg Tool Lanyard
533-100011

6 4.5" Webbing Tool Connectors
533-100352

1 12-ft Roll of Premium Self-Adhering Tool Binding Tape
533-700101

Chemical and Liquid PROTECTION

EN 374-3



AJK

WHAT IS THE ALPHA CODING LISTING BELOW THE PICTOGRAM?

EN 374-3 coding: In order for a glove to receive the pictogram as shown, the glove must achieve a breakthrough time greater than (>) 30 minutes for at least 3 chemicals from the 12 listed below.

CODE LETTER	CHEMICAL	GAS NUMBER	CATEGORY
A	Methanol	67-56-1	Primary alcohol
B	Acetone	67-64-1	Ketone
C	Acetonitrile	75-05-8	Nitrile compound
D	Dichloromethane	75-09-2	Chlorinated paraffin
E	Carbon disulfide	75-15-0	Sulfur-containing organic compound
F	Toluene	108-88-3	Aromatic hydrocarbon
G	Diethylamine	109-89-7	Amine
H	Tetrahydrofuran	109-99-9	Heterocyclic and ethereal compound
I	Ethyl acetate	141-78-6	Ester
J	n-Heptane	142-85-5	Saturated hydrocarbon
K	Sodium hydroxide 40%	1310-73-2	Inorganic base
L	Sulfuric acid 96%	7664-93-9	Inorganic mineral acid

BREAKTHROUGH TIME (BTT)

The number of minutes from initial contact with a test chemical until it is first detected on the inside of the glove.

BREAKTHROUGH TIME PROTECTION INDEX

Each chemical tested is classified in terms of breakthrough time (performance level 0 to 6.)

PROTECTION INDEX

> 10 Minutes	Class 1
> 30 Minutes	Class 2
> 60 Minutes	Class 3
> 120 Minutes	Class 4
> 240 Minutes	Class 5
> 480 Minutes	Class 6

DISPOSABLE GLOVE GRADES

MEDICAL/EXAM GRADE

Medical/Exam grade disposable gloves go through rigorous factory-level testing to ensure the glove is high enough quality to provide effective barrier protection in higher-risk conditions. These gloves are commonly used in general clinics, emergency, first aid and on the frontline(s).

FOOD GRADE

Food grade disposable gloves are an effective barrier to prevent cross-contamination by preventing hands from coming into direct contact with food, proteins and oils. Often used as a liquid barrier under or over cut-resistant gloves to prevent contamination and wetness.

INDUSTRIAL GRADE

Industrial grade disposable gloves are typically 4 to 5 mill in thickness on average. Often used as limited use barrier gloves when coming into contact with unavoidable greases, oils, paints and other contaminants.



Latex

Beef and Pork Processing / Fish Processing /
Fruit and Vegetable Processing / Poultry Processing /
Chemical Handling / Chemical Refining / Cleaning /
Light-Assembly Tasks / Refining—Oil and Petrol /
Chemical Processing and Preparation /
Maintenance of Plant and Heavy Equipment /
Detergents and Cleaning Liquids / Janitorial Use



Scan it



EN 374
ABK

47-L170Y
- Raised diamond pattern for enhanced grip in wet or dry conditions
- Unlined to reduce potential of product contamination

STRAIGHT CUFF



EN 374
AKL

47-L210T
- Roughened sandblast pattern for enhanced grip in wet conditions
- Longer cuff for additional forearm protection

ROLLED CUFF



EN 374
AKL

48-L185B
- Honeycomb pattern for enhanced grip
- Pinked cuff offers additional tear resistance

PINKED CUFF

For general maintenance applications

Assurance® Unlined Latex

STYLE NUMBER ▲	EN 374	Z/CFR	CFIA	POLYMER	COLOR	THICKNESS	CUFF	LENGTH	CONSTRUCTION	GRIP PATTERN	LINING	SIZES
47-L161B	-	Yes	Yes	Latex	Blue	16 mil	Rolled	12"	Unsupported	Raised Diamond	Unlined	S-XL
47-L161N	-	Yes	Yes	Latex	Natural	16 mil	Rolled	12"	Unsupported	Raised Diamond	Unlined	S-XL
47-L170Y	ABK	Yes	Yes	Latex	Yellow	18 mil	Rolled	12"	Unsupported	Raised Diamond	Unlined	M-XL
47-L171B	ABK	Yes	Yes	Latex	Blue	18 mil	Straight	12"	Unsupported	Raised Diamond	Unlined	S-XL
47-L171N	ABK	Yes	Yes	Latex	Natural	18 mil	Straight	12"	Unsupported	Raised Diamond	Unlined	S-XL
47-L442	AKL	No	No	Latex	Black	44 mil	Rolled	17"	Unsupported	Smooth	Unlined	M-XL
47-L210T	-	Yes	No	Latex	Orange	18 mil	Rolled	15"	Unsupported	Roughened Sandblast	Unlined	S-XL
52L100	-	Yes	No	Latex	Blue	18 mil	Straight	12"	Unsupported	Raised Diamond	Unlined	7-10

Assurance® Flock Lined Latex

48-L140Y	-	No	No	Latex	Yellow	14 mil	Rolled	12"	Unsupported	Honeycomb	Flocked	S-XL
48-L160Y	-	Yes	Yes	Latex	Yellow	16 mil	Straight	12"	Unsupported	Honeycomb	Flocked	S-2XL
48-L185B	AKL	Yes	Yes	Latex	Blue	18 mil	Pinked	12"	Unsupported	Honeycomb	Flocked	S-XL
48-L185P	AKL	Yes	Yes	Latex	Pink	18 mil	Pinked	12"	Unsupported	Honeycomb	Flocked	S-XL
48-L185T	-	No	Yes	Latex	Orange	18 mil	Rolled	12"	Unsupported	Honeycomb	Flocked	S-XL
48-L185Y	AKL	No	No	Latex	Yellow	18 mil	Rolled	12"	Unsupported	Honeycomb	Flocked	S-XL
48-L187Y	AKL	No	No	Latex	Yellow	18 mil	Rolled	12"	Unsupported	Honeycomb	Flocked	S-XL
48-L302T	-	No	No	Latex	Orange	28 mil	Rolled	12"	Unsupported	Honeycomb	Flocked	S-2XL
48-L212Y	ABK	Yes	Yes	Latex	Yellow	21 mil	Rolled	12"	Unsupported	Raised Diamond	Flocked	XS-XL
48-L300K	-	Yes	No	Latex	Black	28 mil	Straight	12"	Unsupported	Raised Diamond	Flocked	M-2XL



Nitrile

Cleaning / Laboratory Analysis / Printing Industries /
Refining – Oil and Petrol / Agrochemicals / Assembly /
Chemical Processing and Preparation / Degreasing /
Fruit and Vegetable Processing / Fish Processing /
Meat and Poultry Processing / Janitorial Use /
Beef and Pork Processing



Scan it



EN 374
AKL

50-N092B

- Lightweight design offers high dexterity and sensitivity
- Raised diamond pattern for enhanced grip in wet or dry conditions
- CFIA approved

RAISED DIAMOND GRIP

EN 374
AKL

50-N2272G

- Sandpatch pattern for an enhanced grip
- Longer cuff for additional forearm protection

SANDPATCH GRIP

EN 374
AKL

50-N150G

- Raised diamond pattern for an enhanced grip
- Flock lining provides increased comfort and ease of donning

FLOCK LINED

Protects from solvents and oil-based chemicals

Assurance® Unlined Nitrile

STYLE NUMBER △	EN 374	Z1 CFR	CFIA	POLYMER	COLOR	THICKNESS	CUFF	LENGTH	CONSTRUCTION	GRIP PATTERN	LINING	SIZES
50-N092B	AJKL	Yes	Yes	Nitrile	Blue	8 mil	Straight	13"	Unsupported	Raised Diamond	Unlined	S-2XL
50-N110G	ABK	Yes	Yes	Nitrile	Green	11 mil	Straight	13"	Unsupported	Raised Diamond	Unlined	S-2XL
50-N140B	AJK	Yes	Yes	Nitrile	Blue	15 mil	Straight	13"	Unsupported	Raised Diamond	Unlined	S-2XL
50-N140G	AJK	Yes	Yes	Nitrile	Green	15 mil	Straight	13"	Unsupported	Raised Diamond	Unlined	S-2XL
50-N2250G	AKL	Yes	Yes	Nitrile	Green	22 mil	Straight	15"	Unsupported	Raised Diamond	Unlined	M-2XL
50-N2272G	AJK	Yes	Yes	Nitrile	Green	22 mil	Straight	18"	Unsupported	Sandpatch	Unlined	M-2XL

Assurance® Flock Lined Nitrile

50-N150G	AJKL	Yes	Yes	Nitrile	Green	15 mil	Straight	13"	Unsupported	Raised Diamond	Flocked	S-2XL
50-N160B	AJK	Yes	No	Nitrile	Blue	15 mil	Straight	13"	Unsupported	Raised Diamond	Flocked	S-2XL
50-N160G	AJK	Yes	Yes	Nitrile	Green	15 mil	Straight	13"	Unsupported	Raised Diamond	Flocked	S-2XL



Supported Blended Polymer

Scan it

Gearbox Assembly / General Handling / Handling Small Castings /
Handling of Small Components / Light Metal Fabrication / Parts Handling / Maintenance



▲ 56-630



▲ 56-633



▲ 56-635

MaxiChem®

- Lightweight design provides high dexterity and sensitivity
- Micro-cup non-slip grip provides enhanced grip in wet and oily conditions
- Tailored cuff enhances fit for superior control

Designed and developed for those working with chemicals who require higher levels of protection

STYLE NUMBER ▲	EN 374	EN 388	CFA	POLYMER	POLYMER COLOR	GRIP COLOR	COATING COVERAGE	CUFF	LENGTH	CONSTRUCTION	GRIP PATTERN	LINING	SIZES
56-630	AKL	4121	Yes	Nitrile	Green	Black	Full	Gauntlet	12"	Supported	Non-Slip	Nylon	S-2XL
56-633	AKL	4342	No	Nitrile	Green	Black	Full	Gauntlet	12"	Supported	Non-Slip	Engineered Yarn	S-2XL
56-635	AKL	4121	Yes	Nitrile	Green	Black	Full	Gauntlet	14"	Supported	Non-Slip	Nylon	S-2XL



Neoprene Flock Lined Canners



52-3665

- Provides superior protection from a wide range of chemicals such as acids, caustics, solvents and oils
- Raised diamond pattern for enhanced grip in wet or dry conditions



52-3670

- Heavyweight for enhanced protection
- Raised diamond pattern for enhanced grip in wet or dry conditions

Cleaning / Laboratory Analysis / Refining – Oil and Petrol
Petrochemicals / Specialty Chemicals

STYLE NUMBER ▲	EN 374	Z1 CFR	CFA	POLYMER	COLOR	THICKNESS	CUFF	LENGTH	CONSTRUCTION	GRIP PATTERN	LINING	SIZES
52-3665	AKL	Yes	No	Neoprene	Black	28 mil	Straight	12"	Unsupported	Raised Diamond	Flocked	S-XL
52-3670	AKL	Yes	No	Neoprene over Latex	Blue/Yellow	28 mil	Straight	12"	Unsupported	Raised Diamond	Flocked	S-3XL
52-3672	---	Yes	No	Neoprene over Latex	Blue/Yellow	19 mil	Straight	12"	Unsupported	Raised Diamond	Flocked	S-XL
52-3671	AKL	Yes	No	Neoprene over Latex	Blue/Yellow	28 mil	Straight	12"	Unsupported	Honeycomb	Flocked	S-2XL



ProCoat® PVC Dipped Gloves



Scan it

Chemical Processing / Oil Refining / Petrochemical / Plant Maintenance /
Handling Equipment and Abrasive Materials Coated with Oils, Grease and Acids



58-8030

- Interlock lining dries quickly and offers better dexterity
- Single dipped construction

SMOOTH GRIP COATING



58-8015R

- Single dipped construction
- Semi rough finish provides better grip in wet conditions

SEMI-ROUGH COATING



HVO1015

- Air infused foam provides impact protection
- Interlock lining dries quickly and offers better dexterity

ROUGH GRIP COATING



58-8120DD

- Double-dipped coating for superior liquid protection and extended wear
- Sandy finish offers better grip in wet conditions

SANDY GRIP COATING



58-8035DD

- Double-dipped coating for superior liquid protection and extended wear
- Jersey liner provides better comfort

ROUGH ACID COATING



1SP8718

- Single dipped construction
- Extended length provides additional forearm coverage

EXTENDED CUFF

Great for oily and wet conditions

STYLE NUMBER	EN 388	POLYMER	COLOR	CUFF	LENGTH	CONSTRUCTION	GRIP PATTERN Δ	LINING	SIZES	PROP 65
58-8015	4121XX	PVC	Black	Knit Wrist	10"	Supported, Single Dipped	Smooth	Interlock	MENS	-
58-8030	4121XX	PVC	Black	Straight	12"	Supported, Single Dipped	Smooth	Interlock	MENS	-
58-8040	4121XX	PVC	Black	Straight	14"	Supported, Single Dipped	Smooth	Interlock	MENS	-
1047	-	PVC	Black	Straight	14"	Supported, Single Dipped	Smooth	Interlock	L	Δ C&R
1SP8718	-	PVC	Black	Straight	18"	Supported, Single Dipped	Smooth	Interlock	L	Δ C
58-8060	4121XX	PVC	Black	Straight	18"	Supported, Single Dipped	Smooth	Interlock	MENS	-
1087	-	PVC	Black	Straight	18"	Supported, Single Dipped	Smooth	Interlock	L	Δ C&R
58-8015R	4121XX	PVC	Black	Knit Wrist	10"	Supported, Single Dipped	Semi-Rough	Interlock	MENS	-
58-8030R	4121XX	PVC	Black	Straight	12"	Supported, Single Dipped	Semi-Rough	Interlock	MENS	-
1027R	-	PVC	Black	Straight	12"	Supported, Single Dipped	Semi-Rough	Interlock	L	Δ C&R
1027RF	-	PVC	Black	Straight	12"	Supported, Single Dipped	Rough	Interlock	L	Δ C&R
1047RF	-	PVC	Black	Straight	14"	Supported, Single Dipped	Rough	Interlock	L	Δ C&R
J1027RF	-	PVC	Black	Straight	12"	Supported, Single Dipped	Rough	Jersey	L	Δ C&R
J1047RF	-	PVC	Black	Straight	14"	Supported, Single Dipped	Rough	Jersey	L	Δ C&R
HVO1015	4131X	PVC	Hi-Vis Orange	Straight	14"	Supported, Single Dipped	Rough	Interlock	L-2XL	Δ C&R
58-8035DD	4121XX	PVC	Green	Straight	14"	Supported, Double-Dipped	Rough Acid	Jersey	MENS	-
58-8120DD	4121XX	PVC	Black	Straight	10"	Supported, Double-Dipped	Sandy	Interlock	MENS	-
58-8215DD	-	PVC	Black	Knit Wrist	10"	Supported, Double-Dipped	Sandy	Jersey	MENS	-
1SP0712	-	PVC	Black	Straight	12"	Supported, Double-Dipped	Sandy	Jersey	MENS	Δ C
58-8230DD	-	PVC	Black	Straight	12"	Supported, Double-Dipped	Sandy	Jersey	MENS	-
58-8240DD	-	PVC	Black	Straight	14"	Supported, Double-Dipped	Sandy	Jersey	MENS	-
1SP1718	-	PVC	Dark Green	Straight	18"	Supported, Double-Dipped	Sandy	Jersey	MENS	Δ C
58-8362	4121XX	PVC	Black	Straight	12"	Supported, Single Dipped	Sandy	Jersey	MENS	-
58-8364	4121XX	PVC	Black	Straight	14"	Supported, Single Dipped	Sandy	Jersey	MENS	-
58-8431R	4121XX	PVC	Red	Straight	24"	Supported, Single Dipped	Sandy	Interlock	MENS	-

C = Δ WARNING: Cancer - www.P65Warnings.ca.gov R = Δ WARNING: Reproductive Harm - www.P65Warnings.ca.gov C&R = Δ WARNING: Cancer and Reproductive Harm - www.P65Warnings.ca.gov



ProCoat® & PermFlex® XtraTuff™

Insulated Supported PVC & Specialty PVC Blends

Outdoor General Applications / Chemical Handling /
Food Processing / Cold Storage / Cleaning and Degreasing



Scan it



58-7303

- Liquid proof
- Foam insulated to keep hands warm and dry
- Hi-Vis for enhanced hand visibility



58-8658K

- Kevlar® liner provides cut and light heat protection
- Seamless knit construction for enhanced dexterity



58-8650

- Special PVC blend stays soft and flexible in cold applications
- Rough finish provides good grip in wet and dry applications



58-8655

- Special PVC blend stays soft and flexible in oily applications
- Rough coated palm for enhanced grip
- Seamless liner

ProCoat® / XtraTuff™ Insulated Supported PVC

STYLE NUMBER △	EN 374	ANSI CUT	EN 388	POLYMER	COLOR	CUFF	LENGTH	CONSTRUCTION	GRIP PATTERN	LINING	SIZES	PROP 65
58-7303	-	-	-	PVC	Hi-Vis Orange	Knit Wrist	11"	Supported	Smooth	Foam	MENS	▲ C
58-7305	-	-	-	PVC	Hi-Vis Orange	Safety	10"	Supported	Smooth	Foam	MENS	▲ C
58-8658DL	AJK	-	4120X	PVC	Blue	Straight	12"	Supported	Rough	Interlock/Terry	L-2XL	▲ C&R
58-8658K	AJK	A3	4342CX	PVC	Blue	Straight	12"	Supported	Rough	Kevlar®	M-XL	▲ C&R

PermFlex® / XtraTuff™ Specialty PVC Blends

58-8650			3120X	PVC	Brown	Straight	10"	Supported	Rough	Interlock	S-XL	-
58-8651			3120X	PVC	Brown	Straight	12"	Supported	Rough	Interlock	S-XL	-
58-8655			4120X	PVC	Blue	Straight	10"	Supported	Rough	Interlock	S-XL	-
58-8656			4120X	PVC	Blue	Straight	12"	Supported	Rough	Interlock	S-2XL	-

C = ▲ WARNING: Cancer - www.P65Warnings.ca.gov R = ▲ WARNING: Reproductive Harm - www.P65Warnings.ca.gov C&R = ▲ WARNING: Cancer and Reproductive Harm - www.P65Warnings.ca.gov



ActivGrip™ & ChemGrip™

Supported Neoprene & Nitrile Coated

Petrochemical / Refining, Material Handling / Degreasing /
Chemical Handling / Plating / Galvanizing



Scan it



56-AG585

- Superior grip in dry, wet and oily conditions
- Seamless cotton liner for comfort and better fit



57-8630R

- Multi-dipped process provides fully liquid-proof protection
- Jersey liner for enhanced comfort
- Gauntlet cuff

Advanced chemical protection

ActivGrip™ Nitrile Coated with MicroFinish Grip

STYLE NUMBER △	EN 374	EN 388	POLYMER	COLOR	CUFF	LENGTH	CONSTRUCTION	GRIP PATTERN	LINING	SIZES	PROP 65
56-AG566	-	412XX	Nitrile	Green	Straight	12"	Supported	MicroFinish	Interlock	S-XL	
56-AG567	-	412XX	Nitrile	Green	Straight	25"	Supported	MicroFinish	Interlock	S-XL	
56-AG585	-	412XX	Nitrile	Gray	Straight	10"	Supported	MicroFinish	Interlock	XS-XL	
56-AG586	-	412XX	Nitrile	Gray	Straight	12"	Supported	MicroFinish	Interlock	XS-XL	
56-AG588	-	412XX	Nitrile	Gray	Safety	10"	Supported	MicroFinish	Interlock	S-XL	

ChemGrip™ Neoprene Coated

1SN2510	AJKL	-	Neoprene	Black	Knit Wrist	10"	Supported, Multi-Dipped	Smooth	Jersey	L	⚠ C&R
57-8630R	AJKL	312XX	Neoprene	Black	Straight	12"	Supported, Multi-Dipped	Etched	Brushed Interlock	L	
1SN2537	AJKL	312XX	Neoprene	Black	Straight	14"	Supported, Multi-Dipped	Etched	Brushed Interlock	L	⚠ C&R
1SN2539	AJKL	312XX	Neoprene	Black	Straight	18"	Supported, Multi-Dipped	Etched	Brushed Interlock	L	⚠ C&R
57-8653R	AJKL	312XX	Neoprene	Black	Straight	18"	Supported, Multi-Dipped	Etched	Foam	M-L	

Unsupported Butyl Gloves

1UB0007	-	-	Butyl	Black	Straight	14"	Unsupported	Smooth	Unlined	XS-XL	
1UB0007R	-	-	Butyl	Black	Straight	14"	Unsupported	Rough	Unlined	XS-XL	
1UB0014	-	-	Butyl	Black	Straight	14"	Unsupported	Smooth	Unlined	S-XL	
1UB0014R	-	-	Butyl	Black	Straight	14"	Unsupported	Rough	Unlined	XS-XL	
1UB0025R	-	-	Butyl	Black	Straight	14"	Unsupported	Rough	Unlined	S-XL	

C = ⚠ WARNING: Cancer - www.P65Warnings.ca.gov

R = ⚠ WARNING: Reproductive Harm - www.P65Warnings.ca.gov

C&R = ⚠ WARNING: Cancer and Reproductive Harm - www.P65Warnings.ca.gov



Extended Use

Automotive / Assembly / Paint Spraying / Electroplating /
Cleaning / Asbestos Removal / Janitorial Use



Scan it



- 67-306**
- Chemical resistant
 - Latex-free
 - Fish scale surface for wet and dry grip
 - Amazing fit

8 MIL



- 67-308**
- Latex-free
 - Fish scale surface for wet and dry grip
 - Suitable for all food types
 - Bagged for food environments

6 MIL



- 67-307**
- Chemical resistant
 - Latex-free
 - Fish scale surface for wet and dry grip
 - Flexible, snug fit

7 MIL

Ambidextrous Fish Scale Pattern Gives Superior Grip

Grippaz® Technology features a fish scale pattern that provides unparalleled grip performance. Grippaz® gloves are ergonomically designed to provide traction grip on the outside and inside of the glove.



- 67-246**
- Chemical resistant
 - Latex-free
 - Fish scale surface for wet and dry grip
 - Superb snug fit

6 MIL

Also available in orange:
67-246

STYLE NUMBER	21 CFR	CFIA	GRADE	THICKNESS ▾	COLOR	GRIP PATTERN	POWDER	SIZES	BOX COUNT
67-308	Yes	No	Food	8 mil	Blue	Fish Scale	Powder-Free	M-3XL	48
67-307	Yes	No	Industrial	7 mil	Orange	Fish Scale	Powder-Free	S-3XL	50
67-246	Yes	No	Industrial	6 mil	Black	Fish Scale	Powder-Free	S-2XL	50
67-256	Yes	No	Industrial	6 mil	Orange	Fish Scale	Powder-Free	S-2XL	50
67-306	Yes	No	Jan San	6 mil	Yellow	Fish Scale	Powder-Free	S-2XL	48



Scan it

Ambi-dex

Nitrile Single-Use



Inspection / Assembly and Inspection / Equipment Repair and Maintenance /
Painting and Printing / Automotive



▲ 63-338PF



▲ 63-332PF



▲ 63-732PF



▲ 63-632PF



▲ 2940



▲ 63-230PF



▲ 2920

For general duty applications,
dirt and oil

STYLE NUMBER	21CFR	CFIA	GRADE	THICKNESS	COLOR	GRIP PATTERN Δ	POWDER	SIZES	BOX COUNT
63-338PF	Yes	No	Industrial	8 mil	Blue	Textured	Powder-Free	S-XL	50
2940	Yes	No	Industrial	7 mil	Orange	Textured	Powder-Free	S-3XL	90
63-336PF	Yes	No	Industrial	6 mil	Blue	Textured	Powder-Free	S-XL	100
63-332	Yes	No	Industrial	5 mil	Blue	Textured	Powdered	S-2XL	100
63-332PF	Yes	No	Industrial	5 mil	Blue	Textured	Powder-Free	XS-2XL	100
63-732PF	Yes	No	Industrial	5 mil	Black	Textured	Powder-Free	S-XL	100
63-632PF	Yes	No	Industrial	4 mil	Black	Textured	Powder-Free	S-XL	100
1UH0004N	Yes	No	Food	4 mil	Hi-Vis green	Textured	Powder-Free	S-2XL	100
63-532PF	Yes	No	Food	4 mil	Blue	Textured	Powder-Free	S-2XL	100
63-230PF	Yes	No	Food	3 mil	Blue	Textured	Powder-Free	S-XL	100
2920	Yes	No	Industrial	5 mil	Black	Textured	Powder-Free	S-2XL	100
2910	Yes	No	Industrial	4 mil	Blue	Textured	Powder-Free	XS-2XL	100



Ambi-dex

Heavy-Duty Latex Single-Use

Food Processing / Food Service / Laboratory Applications /
Production / Inspection



Scan it



2550

- Powder-free for clean comfort and superior tactile sensitivity
- Fully textured palm and finger provides a good grip in wet or dry environments

Added Strength for Demanding Jobs

Ambi-Thix[®] Extra-Thick Latex

STYLE NUMBER	21CFR	CFIA	GRADE	THICKNESS	COLOR	GRIP PATTERN	POWDER	SIZES	BOX COUNT
2550	Yes	No	Exam	14 mil	Blue	Textured	Powder-Free	S-2XL	50

Ambi-dex

Latex Single-Use



INDUSTRIAL GRADE

Applications:
Production
Inspection
Cleaning

PREMIUM GRADE

Applications:
Laboratories
Inspection
Examinations
Pharmacy

Laboratory Applications / Cleaning / Inspection /
Production / Light Duty Applications

Ambi-dex[®] Latex

STYLE NUMBER	21CFR	CFIA	GRADE	THICKNESS	COLOR	GRIP PATTERN	POWDER	SIZES	BOX COUNT
2850	Yes	No	Industrial	7 mil	Natural	Textured	Powder-Free	S-XL	100
62-322PF	Yes	No	Industrial	5 mil	Natural	Textured	Powder-Free	XS-XL	100
62-321PF	Yes	No	Premium	5 mil	Natural	Textured	Powder-Free	S-XL	100



Ambi-dex

Vinyl & Non-Latex Synthetic Single-Use

Food Processing / Food Production / Laboratory Applications /
Pharmaceuticals / Electronics



Scan it



64-V77BPF

- Offers heavy-duty protection without sacrificing comfort, fit and dexterity



64-V2000PF

- Optimal combination of comfort, fit, flexibility, tactile sensitivity and performance



64-435PF

- Powder-free for clean comfort and superior tactile sensitivity
- Heavy-duty protection for additional strength and liquid run-off



64-346PF

- Have the look, fit and feel of latex without the concern of natural rubber latex proteins

Ambi-dex® Heavy-Duty Vinyl

STYLE NUMBER	ZI CFR	CFIA	GRADE	THICKNESS	COLOR	GRIP PATTERN	POWDER	SIZES	BOX COUNT	PROP 65
64-435PF	Yes	No	Premium	5 mil	White	Smooth	Powder-Free	S-XL	100	⚠️ C&R
64-V77BPF	Yes	No	Industrial	5 mil	Blue	Smooth	Powder-Free	S-XL	100	⚠️ C&R

Ambi-dex® Vinyl

64-V2000	Yes	No	Industrial	4 mil	White	Smooth	Powdered	S-2XL	100	⚠️ C&R
64-V2000PF	Yes	No	Industrial	4 mil	White	Smooth	Powder-Free	S-2XL	100	⚠️ C&R

Ambi-dex® Non-Latex Synthetic

64-346PF	Yes	No	Industrial	4 mil	White	Smooth	Powder-Free	S-XL	100	⚠️ C&R
----------	-----	----	------------	-------	-------	--------	-------------	------	-----	--------

C = ⚠️ **WARNING:** Cancer - www.P65Warnings.ca.gov R = ⚠️ **WARNING:** Reproductive Harm - www.P65Warnings.ca.gov C&R = ⚠️ **WARNING:** Cancer and Reproductive Harm - www.P65Warnings.ca.gov



Liquid Splash Protection

Scan it



205-420JH
Jacket



205-420B
Bib Overalls



205-420CV
Coveralls



205-375FR
Jacket & Bib Overalls

Assurance® ChemFR™ (Test method ASTM D6413)

STYLE NUMBER	COLOR	GARMENT	THICKNESS	FABRIC	CLOSURE	POCKETS	SIZES	PROP 65
205-420JH	Green	Jacket	0.42 mm	PVC / Nylon / PVC	Snap & Zipper	0	S-5XL	⚠️ C&R
205-420B	Green	Bib Overalls	0.42 mm	PVC / Nylon / PVC	-	0	S-5XL	⚠️ C&R
205-420CV	Green	Coveralls	0.42 mm	PVC / Nylon / PVC	Snap & Zipper	0	S-5XL	⚠️ C&R
4045	Green	Bib and Jacket	0.40 mm	PVC / Polyester / PVC	Snap	2	M-4XL	⚠️ C&R

Assurance® HydroFR™ (Test method ASTM D6413)

205-375FR	Yellow	Jacket & Bib Overalls	0.33 mm	PVC / Polyester / PVC	Hook & Loop and Zipper	2	S-8XL	⚠️ C&R
-----------	--------	-----------------------	---------	-----------------------	------------------------	---	-------	--------

C = ⚠️ WARNING: Cancer - www.P65Warnings.ca.gov R = ⚠️ WARNING: Reproductive Harm - www.P65Warnings.ca.gov C&R = ⚠️ WARNING: Cancer and Reproductive Harm - www.P65Warnings.ca.gov

Foot Protection



▲ 383-890

▲ 380-800

▲ 380-900

Boss® Foot Protection

STYLE NUMBER	GRADE	COLOR	MATERIAL	LENGTH	FEATURES		CLOSURE	SIZES
					STEEL TOE	STEEL SHANK		
383-890	Premium	Black	Polyblend	16"	•	•	Slip-On	6-14
380-800	Premium	Black	PVC	16"			Slip-On	6-14
380-900	Premium	White	PVC	16"			Slip-On	6-14



Safety Goggles

Scan it



FOGLESS³SIXTY™
TECHNOLOGY

MISSION™
251-63-0520-RHB

Helps provide protection against projectiles, impact and liquid splash



CONTEMPO™
251-5300-400

Modern styling with swivel headband adjustment



FOGLESS³SIXTY™
TECHNOLOGY

STONE™
251-60-0020

Optional visor attachment for face protection

VISOR: 251-60-000V



SOFTSIDES
248-5190-400B

Soft, flexible vinyl body molds comfortably to the face

STYLE	LENS	COATING	FRAME	STANDARDS MET				BASE CURVE	VENTS	FRAME MATERIAL	HEADBAND	PROP 65
				ANSI Z87.1+	CSA Z94.3	ANSI/D3 DROPLET						
251-63-0520-RHB	☐ Clear	Anti-Scratch / Fogless ³ Sixty™	■ Dark Green	•		•	6	Indirect ventilation	TPR	Neoprene Rubber	⚠ ^R	
251-5300-400	☐ Clear	Anti-Scratch, Anti-Fog	■ Light Blue	•			5.75	Indirect ventilation	PVC	Elastic	⚠ ^R	
251-60-0020	☐ Clear	Anti-Scratch / Fogless ³ Sixty™	■ Gray	•		•	5	Indirect ventilation	Synthetic Rubber	Elastic	⚠ ^R	
251-60-000V	■ Gray	-	-	•			-	-	Polycarbonate	-	⚠ ^R	
248-5190-400B	☐ Clear	Anti-Scratch, Anti-Fog	☐ Clear			•	Flat	Indirect ventilation	Vinyl	Elastic	⚠ ^R	

C = ⚠ **WARNING:** Cancer - www.P65Warnings.ca.gov R = ⚠ **WARNING:** Reproductive Harm - www.P65Warnings.ca.gov C&R = ⚠ **WARNING:** Cancer and Reproductive Harm - www.P65Warnings.ca.gov

Face Shields and Brackets

251-01-5211
Flat



251-01-5210
Curved



▲ 251-01-5271
251-01-5270 ▶



STYLE NUMBER	MATERIAL	LENS	THICKNESS	STANDARDS MET			SIZE	SHAPE	PROP 65
				ANSI Z87.1+	ANSI Z87.1	CSA Z94.3			
251-01-5211	PETG	Clear	0.040"	•			8"x15.5"	Flat	-
251-01-5210	Polycarbonate	Clear	0.040"		•	•	7"x15.5"	Curved	⚠ ^R

R = ⚠ **WARNING:** Reproductive Harm - www.P65Warnings.ca.gov

STYLE NUMBER	COMPATIBLE WITH	HOLE PATTERN	MATERIAL
251-01-5271	Cap Style	Universal	Aluminium
251-01-5270	Full Brim	Universal	Aluminium



Scan it

Liquid Splash Protection Kits

KIT 1







Petrochemical Industries / Sanitation & Janitorial /
Sewer & Water Works / Heavy-Duty Industrial Plant Maintenance

KIT 2



Hydroblast & Pressure Washing / Construction & Shipyards / Janitorial /
Agricultural Chemical Spraying / Industrial Plant Maintenance

Liquid Splash Protection Kits*

COMPONENTS					
KIT	PROTECTIVE CLOTHING	HARD HAT	BRACKET	FACE PROTECTION	FOOT PROTECTION
KIT 1	205-420CV	280-HP241R-01		251-60-0020 251-60-000V	380-800
KIT 2	205-375FR	280-HP241R-02	251-01-5270	251-01-5211	380-900

* All kit components are sold separately



Food SAFETY

This section of the catalog contains PPE commonly used in food manufacturing, processing and handling applications where both worker safety and food safety are essential.

Gloves and sleeves are used to help protect workers against cuts, heat or cold exposure. They are also used to protect against liquid and chemical splash as well as immersion.

Items like bouffants, beard covers and single-use gloves are pivotal in the most important task of food safety – keeping the product from being contaminated.

Other PPE products – including eye and hearing protection, boots, aprons and clothing – focus on worker safety, helping protect workers from dangerous noise and fluid splash or bone shards during the manufacturing process.

Gloves and Sleeves

Gloves and sleeves from PIP® provide a wide range of protective properties; from disposable gloves that help prevent product contamination while keeping hands clean and dry, to unsupported and supported polymer gloves that provide chemical, liquid and thermal protection, to seamless knit gloves that provide high-level cut protection. PIP® tests products to be compliant with U.S. and European standards to ensure worker confidence and safety.

- > ANSI/ISEA 105-2016 is the U.S. standard for specific performance properties related to mechanical protection, including cut, puncture and abrasion resistance.
- > EN ISO 374-1:2016 addresses terminology and performance requirements for chemical risks.

Food Safety Specifications

Food Safety Specifications – The Code of Federal Regulations Title 21 (21 CFR) contains rules established by the U.S. Food and Drug Administration (FDA) that are organized into more than 200 parts. Parts 174 and 177 relate to items used in food processing, manufacturing, preparation and handling.

Part 174 addresses specifications related to “items that come into contact with food as part of packaging, holding, or processing, but are not intended to be added directly to, become a component, or have a technical effect in or on the food” as Indirect Food Additives. Because gloves, in particular, come into contact with food during production, the materials used in making protective gloves and sleeves are included in this group. Part 177 addresses specifications related to materials or polymers. All the gloves and sleeves that PIP® recommends for food contact are synthetic and polymer-based.

Product noted within this catalog as 21 CFR complaint are deemed to be made from compliant materials.



**THE #1 TRUSTED BRAND FOR HIGH-RISK
FOOD INDUSTRY WORKERS**

Made in the USA, Claw Cover® gloves and sleeves are designed to provide high-level cut protection while complying with both U.S. and Canadian standards for food contact. Claw Cover® gloves and sleeves are launderable and can be used for operations where direct, indirect and incidental contact with food may occur.



**EXTREME CUT PROTECTION
FOR FOOD PROCESSING**

US Mesh® is the only choice for serious users in Food Safety. This preferred line of steel mesh gloves, sleeves and garments delivers maximum cut protection and significant protection against stabs and punctures for Food Processing operations.



Scan it



US MESH®

PROTECT FOOD WORKERS
FROM EXTREME CUT HAZARDS

Butchering / Cleaning / Food Preparation / Knife Sharpening



21
CFR

USM-1105

- Original adjustable closure with sewn-on web strap and snap, side split for easy donning and doffing
- 4-ring joined to protect against knife stabs and punctures
- Ergonomically constructed for maximum wearer comfort and safety
- Compliant with FDA 21 CFR 177.2800 and approved for direct food contact



21
CFR

USM-1147

- Metal spring is self-adjusting to the right fit
- All metal design features a fully-enclosed spring at the wrist for a secure, comfortable fit
- 4-ring joined to protect against knife stabs and punctures
- Ergonomically constructed for maximum wearer comfort and safety
- Compliant with FDA 21 CFR 177.2800 and approved for direct food contact



21
CFR

USM-1180

- Steel prong for a fully adjustable, comfortable fit
- Premium 4-ring hook ups on all glove seams for the ultimate in strength and puncture resistance
- Compliant with FDA 21 CFR 177.2800 and approved for direct food contact



21
CFR

USM-1190

- Original adjustable closure with sewn-on web strap and snap, side split for easy donning and doffing
- 7 mm steel rings which are more easily recognized by metal detectors
- Compliant with FDA 21 CFR 177.2800 and approved for direct food contact



21
CFR

USM-1305

- Original adjustable closure with two replaceable web straps with snap closure
- Premium 4-ring hook ups on all glove seams for the ultimate in strength and puncture resistance
- Mid-length cuff for extended coverage of the wrist
- Compliant with FDA 21 CFR 177.2800 and approved for direct food contact



21
CFR

USM-1547

- Metal self-adjusting, spring for the right fit, fully enclosed in mesh to avoid pinches
- Max-length cuff with an all metal design features a fully-enclosed spring at the wrist and forearm for a secure, comfortable fit
- Stiffeners in cuff to keep cuff in place on arm
- Compliant with FDA 21 CFR 177.2800 and approved for direct food contact



21
CFR

USM-1350

- An additional layer of metal mesh between index and middle finger to reinforce that area often used when working with meat hooks
- Mid-length cuff extends protection over wrist, with two adjustable straps for customized fit
- Compliant with FDA 21 CFR 177.2800 and approved for direct food contact



21
CFR

USM-3105

- Wrist-to-shoulder sleeve includes an adjustable chest strap that provides a custom fit and keeps the sleeve in position for all-day wear
- Web cuff at the wrist includes adjustable snap closure
- Compliant with FDA 21 CFR 177.2800 and approved for direct food contact

Hand Protection

STYLE	21 CFR	MATERIAL	CLOSURE	LENGTH	SIZES
USM-1105	Yes	316L Surgical Grade Stainless Steel	Adjustable Snap Strap	Wrist	2XS-3XL
USM-1147	Yes	316L Surgical Grade Stainless Steel	Self-Adjusting Metal Spring	Wrist	XS-XL
USM-1180	Yes	316L Surgical Grade Stainless Steel	Metal Steel Prong	Wrist	XS-2XL
USM-1190	Yes	316L Surgical Grade Stainless Steel	Adjustable Snap Strap	Wrist	XS-2XL
USM-1305	Yes	316L Surgical Grade Stainless Steel	Adjustable Snap Strap	Mid-Length	XS-XL
USM-1347	Yes	316L Surgical Grade Stainless Steel	Self-Adjusting Metal Spring	Mid-Length	XS-XL
USM-1350	Yes	316L Surgical Grade Stainless Steel	Adjustable Snap Strap	Mid-Length	XS-2XL
USM-1380	Yes	316L Surgical Grade Stainless Steel	Metal Steel Prong	Mid-Length	XS-2XL
USM-1547	Yes	316L Surgical Grade Stainless Steel	Self-Adjusting Metal Spring	Max-Length	XS-XL
USM-1580	Yes	316L Surgical Grade Stainless Steel	Metal Steel Prong	Max-Length	XS-2XL

Arm Protection

USM-3105	Yes	316L Surgical Grade Stainless Steel	Adjustable Snap Strap	-	S-2XL
----------	-----	-------------------------------------	-----------------------	---	-------



Scan it

Metal Mesh Garments

Aprons



USM-2100

- Stainless steel rings deliver the highest level of cut resistance available, plus significant protection against stabs and punctures
- Adjustable elastic straps help customize the fit
- Compliant with FDA 21 CFR 1772800 and approved for direct food contact



USM-2107

- Stainless steel rings deliver the highest level of cut resistance available, plus significant protection against stabs and punctures
- All stainless steel front with 3-piece elastic strap set for customized fit
- Compliant with FDA 21 CFR 1772800 and approved for direct food contact

Shirt



USM-3315

- The neck slit makes it easy to take metal mesh t-shirt on and off
- Wrist-to-shoulder sleeves feature web cuffs with adjustable snap closure
- Compliant with FDA 21 CFR 1772800 and approved for direct food contact

Tunics



USM-4300L

- Full body tunic provides protection from shoulders to knees, front and back
- The lightweight stainless steel wire allows for greater comfort without sacrificing durability or safety
- Compliant with FDA 21 CFR 1772800 and approved for direct food contact



USM-4352L

- Extended apron front and full back (24") provides full protection, with added belly guard for enhanced safety
- The lightweight stainless steel wire allows for greater comfort without sacrificing durability or safety
- Compliant with FDA 21 CFR 1772800 and approved for direct food contact



USM-4301TI

- 40% lighter than stainless steel allowing for a comfortable all-day use
- Full body construction to provide cut protection for upper torso and thighs
- Compliant with FDA 21 CFR 1772800 and approved for direct food contact

Apron

STYLE	21 CFR	MATERIAL	STRAPS	COVERAGE	ENHANCEMENTS	SIZES
USM-2100	Yes	316L Surgical Grade Stainless Steel	Adjustable Elastic Straps	-	-	20 x 34
USM-2107	Yes	316L Surgical Grade Stainless Steel	Adjustable Elastic Straps	-	-	20 x 34

Shirt

USM-3315	Yes	316L Surgical Grade Stainless Steel	-	Wrist-to-Shoulder	Double-Sleeved	XS-3XL
----------	-----	-------------------------------------	---	-------------------	----------------	--------

Tunic

USM-4300L	Yes	316L Surgical Grade Stainless Steel	-	Upper Torso and Thighs	-	S-3XL
USM-4352L	Yes	316L Surgical Grade Stainless Steel	-	Upper Torso and Thighs, and Belly Guard	-	XS-2XL
USM-4301TI	Yes	Titanium wire	-	Upper Torso and Thighs	-	S-XL



Scan it



HPPE

IDEAL FOR
FOOD PROCESSING WORKERS

Cutting / Chopping / Trimming / Filletting



ANSI A6 ANSI A9

CC-D3

- A6 knit glove is ideal for applications where extremely sharp cutting instruments are used
- ATA fiber patch (A9) reinforces highest cut risk areas

HIGHEST RISK



ANSI A7

13-131

- Lightweight cut resistant glove with antimicrobial treatment
- Compliant with FDA 21 CFR 1772800 and approved for direct food contact



ANSI A7

13-231

- Lightweight cut resistant glove with antimicrobial treatment
- Compliant with FDA 21 CFR 1772800 and approved for direct food contact

AVAILABLE WITH EXTENDED CUFF



ANSI A7

10-C6GY

- Highly durable 10-gauge cut resistant glove ideal for food processing
- Compliant with FDA 21 CFR 1772800 and approved for direct food contact

Available with extended cuff:
10-C6GYEC



ANSI A7

10-C5HVOCMX

- Highly durable 10-gauge cut resistant glove ideal for food processing
- Sta-COOL™ plating is cool against the skin

MORE COMFORT

Available in gray:
10-C5GYCMX



ANSI A6

10-121

- Highly durable 10-gauge cut resistant glove ideal for food processing
- Compliant with FDA 21 CFR 1772800 and approved for direct food contact



ANSI A6

7-221

- Highly durable 7-gauge cut resistant glove ideal for food processing
- Compliant with FDA 21 CFR 1772800 and approved for direct food contact



ANSI A5

13-121

- Lightweight cut resistant glove with antimicrobial treatment
- Compliant with FDA 21 CFR 1772800 and approved for direct food contact



ANSI A5

13-221

- Lightweight cut resistant glove with antimicrobial treatment
- Compliant with FDA 21 CFR 1772800 and approved for direct food contact

MADE IN AMERICA

Cut Protection for Food Industry Workers™

Claw Cover® with HPPE Technology

STYLE	CF	ANSI CUT	Z1CFR	MATERIAL	COLOR	CONSTRUCTION	GAUGE	WEIGHT	GRIP	SIZES
10-191	C19	A9	Yes	HPPE/Steel Blend & Sta-COOL™ Plating	Gray	Seamless Knit	10	Medium Weight	Uncoated	XS-XL
CC-D3	-	A9	Yes	HPPE / Steel Blend with ATA® Fiber Patch	Gray	Seamless Knit	7	Heavyweight	Uncoated	XS-XL
13-131	C13	A7	Yes	HPPE/Steel Blend & Sta-COOL™ Plating	Gray	Seamless Knit	13	Lightweight	Uncoated	XS-2XL
13-231	C13	A7	Yes	HPPE/Steel Blend & Sta-COOL™ Plating	White	Seamless Knit	13	Lightweight	Uncoated	S-XL
10-C6GYEC	-	A7	Yes	HPPE/Steel Blend	Gray	Seamless Knit	10	Medium Weight	Uncoated	S-XL
10-C6GY	C6	A7	Yes	HPPE/Steel Blend	Gray	Seamless Knit	10	Medium Weight	Uncoated	S-2XL
10-C5HVOCMX	-	A7	Yes	HPPE/Steel Blend & Sta-COOL™ Plating	Hi-Vis Orange	Seamless Knit	10	Medium Weight	Uncoated	S-3XL
10-121	C3	A6	Yes	HPPE/Steel Blend	Gray	Seamless Knit	10	Medium Weight	Uncoated	S-2XL
7-221	C4	A6	Yes	HPPE/Steel Blend	White	Seamless Knit	7	Heavyweight	Uncoated	XS-2XL
13-121	C2	A5	Yes	HPPE/Steel Blend	Gray	Seamless Knit	13	Lightweight	Uncoated	XS-2XL
13-221	C2	A5	Yes	HPPE/Steel Blend	White	Seamless Knit	13	Lightweight	Uncoated	S-XL
10-131	-	A8	Yes	High-Tenacity Poly/Steel Blend	Gray	Seamless Knit	10	Medium Weight	Uncoated	XS-2XL
10-231	-	A8	Yes	High-Tenacity Poly/Steel Blend	White	Seamless Knit	10	Medium Weight	Uncoated	XS-2XL



Scan it



PolyKor®

AFFORDABLE PROTECTION
OPTIMIZED FOR FOOD APPLICATIONS

Cutting / Chopping / Trimming / Filleting



ANSI
A9

22-600

- Heavy-duty cut resistant glove with antimicrobial treatment
- Complies with FDA food handling requirements 21 CFR, Part 177

HEAVY DUTY & HIGH CUT



ANSI
A9

22-600BK

- Heavy-duty cut resistant glove with antimicrobial treatment
- Complies with FDA food handling requirements 21 CFR, Part 177



ANSI
A9

22-601

- Siligrip coated palm provides a secure wet and dry grip
- Stands up to light solvents, proteins, fats and blood

EXTRA GRIP



ANSI
A9

22-615

- Siligrip coated palm provides a secure wet and dry grip
- Stands up to light solvents, proteins, fats and blood



ANSI
A7

22-650

- Highly durable 7-gauge cut resistant glove ideal for food processing
- Complies with FDA food handling requirements 21 CFR, Part 177

HIGH DURABILITY



ANSI
A6

22-720

- Medium weight cut resistant glove with antimicrobial treatment
- Complies with FDA food handling requirements 21 CFR, Part 177



ANSI
A5

14-ASP700

- Medium weight cut resistant glove ideal for food processing
- Complies with FDA food handling requirements 21 CFR, Part 177



ANSI
A4

22-730

- Lightweight cut resistant glove ideal for food processing
- Complies with FDA food handling requirements 21 CFR, Part 177

Engineered protection for food applications

Claw Cover® with PolyKor® Technology

STYLE	ANSI CUT	21 CFR	MATERIAL	COLOR	CONSTRUCTION	GAUGE	WEIGHT	GRIP	SIZES
14-ASP700	A5	Yes	Claw Cover® made with PolyKor®	Salt & Pepper	Seamless Knit	7	Heavyweight	Uncoated	S-XL
22-600	A9	Yes	Claw Cover® made with PolyKor®	White	Seamless Knit	7	Heavyweight	Uncoated	XS-XL
22-600BK	A9	Yes	Claw Cover® made with PolyKor®	Black	Seamless Knit	7	Heavyweight	Uncoated	S-L
22-601	A9	Yes	Claw Cover® made with PolyKor®	White	Seamless Knit, Hand Specific	7	Heavyweight	Silicone	S-XL
22-615	A9	Yes	Claw Cover® made with PolyKor®	White	Seamless Knit, Half Finger, Hand Specific	7	Heavyweight	Silicone	S-XL
22-650	A7	Yes	Claw Cover® made with PolyKor®	Blue	Seamless Knit	7	Heavyweight	Uncoated	XS-XL
22-720	A6	Yes	Claw Cover® made with PolyKor®	White	Seamless Knit	10	Medium Weight	Uncoated	XS-XL
22-730	A4	Yes	Claw Cover® made with PolyKor®	White	Seamless Knit	13	Lightweight	Uncoated	XS-2XL



Scan it



Dyneema®

UNPARALLELED COMFORT, COOLNESS AND PROTECTION PLUS MULTI-COLOR OFFERING

Filleting / Trimming / Chopping / Cutting

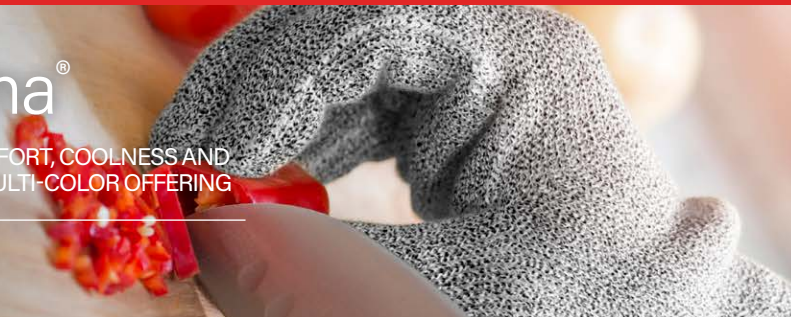

ANSI
A9

22-780

- Ideal for applications where extremely sharp cutting instruments are used
- Complies with FDA food handling requirements 21 CFR, Part 177



ANSI
A7

22-760G

- Highly durable 10-gauge cut resistant glove ideal for food processing
- Complies with FDA food handling requirements 21 CFR, Part 177

THIN + HIGH CUT SCORE



ANSI
A7

22-901

- Secure grip in wet and dry environments
- UV stable, will not degrade over time
- Complies with FDA food handling requirements 21 CFR, Part 177



ANSI
A5

22-765OR

- Heavyweight protection with the comfortable fit of a lightweight glove
- Complies with FDA food handling requirements 21 CFR, Part 177



ANSI
A4

17-DA700

- Heavyweight protection with resistance to light heat and spark
- Superior chemical resistance to acids, alkali and organic solvents

ANSI
A7

HIGH CUT GLOVES ▶

- Excellent cut resistance protects against cuts and scrapes
- Antimicrobial fiber has been shown to inhibit the growth of microorganisms
- Unparalleled comfort, fit and coolness



22-760BB



22-760BG



22-760GRN



22-760NP



22-760



22-760OR



22-760G

Claw Cover® with Dyneema® Technology

STYLE	ANSI CUT	21 CFR	MATERIAL	COLOR	CONSTRUCTION	GAUGE	WEIGHT	GRIP	SIZES	PROP 65
18-SD385	A6	Yes	Claw Cover® made with Dyneema®	Gray	Seamless Knit, Extended Cuff	7	Heavyweight	PVC	L	⚠️ C
22-750	A5	Yes	Claw Cover® made with Dyneema®	White	Seamless Knit	13	Lightweight	Uncoated	XS-XL	-
22-750G	A5	Yes	Claw Cover® made with Dyneema®	Gray	Seamless Knit	13	Lightweight	Uncoated	XS-XL	-
22-750NP	A5	Yes	Claw Cover® made with Dyneema®	Neon Pink	Seamless Knit	13	Lightweight	Uncoated	XS-XL	-
22-751	A5	Yes	Claw Cover® made with Dyneema®	White	Seamless Knit, Hand Specific	13	Lightweight	Silicone	S-XL	-
22-754	A4	Yes	Claw Cover® made with Dyneema®	Gray	Seamless Knit	13	Lightweight	Uncoated	S-XL	-
22-760	A7	Yes	Claw Cover® made with Dyneema®	White	Seamless Knit	10	Medium Weight	Uncoated	XS-XL	-
22-760BB	A7	Yes	Claw Cover® made with Dyneema®	Blue	Seamless Knit	10	Medium Weight	Uncoated	L	-
22-760BG	A7	Yes	Claw Cover® made with Dyneema®	Lime	Seamless Knit	10	Medium Weight	Uncoated	L	-
22-760G	A7	Yes	Claw Cover® made with Dyneema®	Gray	Seamless Knit	10	Medium Weight	Uncoated	XS-XL	-
22-760GRN	A7	Yes	Claw Cover® made with Dyneema®	Green	Seamless Knit	10	Medium Weight	Uncoated	L	-
22-760NP	A7	Yes	Claw Cover® made with Dyneema®	Pink	Seamless Knit	10	Medium Weight	Uncoated	M-L	-
22-760OR	A7	Yes	Claw Cover® made with Dyneema®	Orange	Seamless Knit	10	Medium Weight	Uncoated	XS-2XL	-
22-761	A7	Yes	Claw Cover® made with Dyneema®	Gray	Seamless Knit, Hand Specific	10	Medium Weight	Silicone	S-XL	-
22-765OR	A5	Yes	Claw Cover® made with Dyneema®	Orange	Seamless Knit	10	Medium Weight	Uncoated	XS-XL	-
22-770	A6	Yes	Claw Cover® made with Dyneema®	White	Seamless Knit	7	Heavyweight	Uncoated	XS-L	-
22-780	A9	Yes	Claw Cover® made with Dyneema®	White	Seamless Knit	7	Heavyweight	Uncoated	XS-XL	-
22-900	A7	Yes	Claw Cover® made with Dyneema®	Gray	Seamless Knit	7	Heavyweight	Uncoated	XS-XL	-
22-901	A7	Yes	Claw Cover® made with Dyneema®	Gray	Seamless Knit, Hand Specific	7	Heavyweight	Uncoated	S-XL	-

Claw Cover® with ACP™ Dyneema® Technology

17-DA700	A4	Yes	Claw Cover® made with ACP™ / Dyneema® Blend	Gray	Seamless Knit	7	Heavyweight	Uncoated	S-XL	-
17-DA752	A6	Yes	Claw Cover® made with ACP™ / Dyneema® Blend	Gray	Seamless Knit, Extended Cuff	10	Medium Weight	Silicone	XS-2XL	-

C = ⚠️ WARNING: Cancer - www.P65Warnings.ca.gov R = ⚠️ WARNING: Reproductive Harm - www.P65Warnings.ca.gov C&R = ⚠️ WARNING: Cancer and Reproductive Harm - www.P65Warnings.ca.gov



Scan it



Claw Cover®

THE #1 TRUSTED BRAND FOR
HIGH-RISK FOOD INDUSTRY WORKERS

Cutting / Chopping / Trimming / Filleting



ANSI
A8

CS7GY-AC

- Protection against high cut hazards
- Alligator clip securely keeps the sleeve up on the arm



ANSI
A7

CS7LGY-AC

- Protection against high cut hazards
- Antimicrobial properties will not wash out of the fiber and will last the life of the sleeve



ANSI
A6

7-21

- Protection against high cut hazards
- Alligator clip securely keeps the sleeve up on the arm



ANSI
A6

MS2696

- Protection against medium cut hazards
- Antimicrobial properties will not wash out of the fiber and will last the life of the sleeve



ANSI
A5

MS-1097

- Protection against medium cut hazards
- Antimicrobial properties will not wash out of the fiber and will last the life of the sleeve

Also available with Alligator clip: MS-1097-AC



25-76BB



25-76BG



25-76GRN



25-76NP

ANSI
A7 **21**
CFR

HIGH CUT SLEEVES

- Excellent cut resistance protects against cuts and scrapes
- Antimicrobial fiber has been shown to inhibit the growth of microorganisms
- Unparalleled comfort, fit and coolness

Match these sleeves with 22-760 cut resistant gloves shown on previous page

Claw Cover® Made with HPPE Technology

STYLE	ANSI CUT	21 CFR	MATERIAL	CONSTRUCTION	PLY	TOP CUFF	BOTTOM CUFF	COLOR	STANDARD LENGTH
MS-1097-AC	A5	Yes	Claw Cover® made with HPPE	Seamless Knit	1	Alligator Clip	Straight	Blue	18" - 22"
MS-1097	A5	Yes	Claw Cover® made with HPPE	Seamless Knit	1	Serged	Straight	Blue	22"
MS2696	A6	Yes	Claw Cover® made with HPPE	Seamless Knit	1	Serged	Straight	Gray	14"
CS7LGY-AC	A7	Yes	Claw Cover® made with HPPE	Seamless Knit	1	Alligator Clip	Straight	Gray	22"
CS7GY-AC	A8	Yes	Claw Cover® made with HPPE	Seamless Knit	1	Alligator Clip	Straight	Gray	18"
7-21	A6	Yes	Claw Cover® made with HPPE	Seamless Knit	1	Serged	Straight	White	21"

Claw Cover® Made with Polykor® Technology

25-6	A9	Yes	Claw Cover® made with Polykor®	Seamless Knit	1	Serged	Straight	White	18"
------	----	-----	--------------------------------	---------------	---	--------	----------	-------	-----

Claw Cover® Made with Dyneema® / Dyneema® Diamond Technology

25-76GRN	A7	Yes	Claw Cover® made with Dyneema®	Seamless Knit	1	Serged	Straight	Green	12"
25-76BB	A7	Yes	Claw Cover® made with Dyneema®	Seamless Knit	1	Serged	Straight	Bright Blue	12"
25-76BG	A7	Yes	Claw Cover® made with Dyneema®	Seamless Knit	1	Serged	Straight	Bright Green	12"
25-76NP	A7	Yes	Claw Cover® made with Dyneema®	Seamless Knit	1	Serged	Straight	Neon Pink	12"
20-DAPBTOV	A4	Yes	Claw Cover® made with ACP® / Dyneema®	Blousy	1	Hook & Loop	Thumb Hole	Gray	22"

REPLACE STANDARD 18" LENGTH WITH ANY CUSTOM LENGTH FROM 10" - 24"



Trusted Liquid Protection

Red Meat Processing / Fish Processing /
Fruit and Vegetable Processing / Poultry Processing



Scan it



21
CFR

48-L160Y

- Honeycomb pattern for enhanced grip
- Lightweight offers high dexterity and sensitivity

JANITORIAL / SANITIZING



EN 374
 21
CFR

52-3665

- Heavyweight for enhanced protection
- Raised diamond pattern provides added grip on wet or dry surfaces



EN 374
 21
CFR

52-3671

- Heavyweight for enhanced protection
- Honeycomb pattern for enhanced grip



EN 374
 21
CFR

47-L171N

- Raised diamond pattern provides added grip on wet or dry surfaces
- Unlined to reduce potential of product contamination



21
CFR

47-L161B

- Raised diamond pattern provides added grip on wet or dry surfaces
- Unlined to reduce potential of product contamination



EN 374
 21
CFR

50-N110G

- Lightweight to offer high dexterity and sensitivity
- Raised diamond pattern provides added grip on wet or dry surfaces

Assurance® Unsupported Chemical Resistant Gloves

STYLE	EN 374	21 CFR	CFR	POLYMER	COLOR	THICKNESS	CUFF	LENGTH	CONSTRUCTION	GRIP PATTERN	LINING	SIZES
47-L161B	-	Yes	Yes	Latex	Blue	16 mil	Rolled	12"	Unsupported	Raised Diamond	Unlined	S-XL
47-L171N	ABK	Yes	-	Latex	Natural	18 mil	Straight	12"	Unsupported	Raised Diamond	Unlined	S-XL
48-L160Y	-	Yes	-	Latex	Yellow	16 mil	Straight	12"	Unsupported	Raised Diamond	Unlined	S-2XL
50-N110G	ABK	Yes	Yes	Nitrile	Green	11 mil	Straight	13"	Unsupported	Raised Diamond	Unlined	S-2XL
50-N160G	AKL	Yes	Yes	Nitrile	Green	15 mil	Straight	13"	Unsupported	Raised Diamond	Flocked	XS-2XL
52-3665	AKL	Yes	-	Neoprene	Black	28 mil	Straight	12"	Unsupported	Raised Diamond	Flocked	S-XL
52-3671	AKL	Yes	-	Neoprene over Latex	Blue/Yellow	28 mil	Straight	12"	Unsupported	Honeycomb	Flocked	S-XL



Scan it



Extended Use & Single-Use Hand Protection

BUILT FOR LIQUID AND CONTACT PROTECTION

Food Processing / Food Service / Food Production



EXTENDED USE NITRILE DISPOSABLE GLOVES

Unparalleled performance



67-308

- Globally patented internal and external fish scale grip pattern
- Engineered for handling animal fats and proteins
- Rip-stop design to lower risk of foreign material contamination

Patented fish scale pattern on inside and outside of the glove provides superior grip and toughness



SINGLE-USE NITRILE DISPOSABLE GLOVES

Go-to quality and performance required for food processing and production



63-332PF

- Textured grip provides a good grip in wet or dry environments
- Economical puncture resistance with great comfort, dexterity and tactile sensitivity



63-3314PF

- Optimal combination of comfort, fit, flexibility, tactile sensitivity and performance
- Rolled cuff prevents liquid run-off

VINYL AND POLYETHYLENE DISPOSABLE GLOVES

Lightweight and economical protection required for food service and preparation



64-V2000PF

- Optimal combination of comfort, fit, flexibility, tactile sensitivity and performance
- Rolled cuff prevents liquid run-off
- Bagged for food environments



2745

- Optimal combination of comfort, flexibility, and tactile sensitivity
- Contains no rubber latex proteins
- Complies with FDA food handling requirements 21 CFR, Part 177

Grippaz® Extended Use Nitrile Disposable Gloves

STYLE	Z1 CFR	CFR	MATERIAL	THICKNESS	COLOR	GRIP PATTERN	POWDER	SIZES	BOX COUNT	GRIP PATTERN	SIZES	PROP 65
67-308	Yes	-	Nitrile	8 mil	Blue	Fish Scale	Powder-Free	M-3XL	48	Raised Diamond	S-XL	-

Ambi-Dex® Single-Use Nitrile Disposable Gloves

63-230PF	Yes	-	Nitrile	3 mil	Blue	Textured	Powder-Free	S-XL	100	Raised Diamond	XS-2XL	-
63-332PF	Yes	Yes	Nitrile	5 mil	Blue	Textured	Powder-Free	XS-2XL	100	Honeycomb	S-XL	-
63-338PF	Yes	-	Nitrile	8 mil	Blue	Textured	Powder-Free	S-XL	50	Raised Diamond	S-2XL	-
63-532PF	Yes	-	Nitrile	4 mil	Blue	Textured	Powder-Free	S-2XL	100	Raised Diamond	S-XL	-
63-3314PF	Yes	-	Nitrile	6 mil	Blue	Textured	Powder-Free	S-XL	50	Raised Diamond	XS-2XL	-

Ambi-Dex® Single-Use Vinyl & Polyethylene Disposable Gloves

64-V2000PF	Yes	-	Vinyl	4 mil	White	Smooth	Powder-Free	XS-2XL	100	Raised Diamond	XS-2XL	⚠️ C&R
65-543	Yes	-	Polyethylene	1 mil	Clear	Embossed	Powder-Free	XS-2XL	100	Raised Diamond	XS-2XL	-

⚠️ = **WARNING:** Cancer - www.P65Warnings.ca.gov R = **WARNING:** Reproductive Harm - www.P65Warnings.ca.gov C&R = **WARNING:** Cancer and Reproductive Harm - www.P65Warnings.ca.gov



Scan it

Reusable Arm and Body Protection



ANTIMICROBIAL

CFRZC-16WH-5PK Frock

- Aegis treated antimicrobial stops bacterial and fungal growth
- Raglan sleeves for more movement
- Military collar for a clean look
- Snaps at collar and bottom of zipper and coil zipper for easy donning
- ISO class 3-5
- ESD knit cuffs to help with grounding

CC1245-74-5PK Coverall

- Military collar with color coded hang loop
- Snaps at the top of zipper, leg hems and back of legs
- Raglan sleeves

CFR-60WH-5PK Frock

- Raglan sleeves for more movement
- Military collar for a clean look
- Snaps at front opening and sleeve hem for easy donning

CHB-75WH-20PK Bouffant

- Tricot white 21" bouffant cap
- Soft fabric for comfortability

Reusable clothing that withstands 50-100 washes

Reusable Frocks

STYLE NUMBER	COLOR	GARMENT	CONFIGURATION	CLOSURE	FABRIC	ESD YARN PATTERN	SIZES
CFRZC-16WH-5PK	White	Frock	Military Collar, Zip Front, Knit Cuffs	Zipper	Altessa Grid	Grid	S-3XL
CFR-60WH-5PK	White	Frock	Military Collar, Zip Front, Snap Cuffs	Zipper	Taffeta	Non-ESD	S-3XL
Reusable Coveralls							
CC1245-74WH-5PK	White	Coverall	Military Collar, Zip Front, Knit Cuffs, Snaps at leg hems and back of legs	Zipper	Altessa Grid	Grid	S-3XL
Reusable Bouffants							
CHB-75WH-20PK	White	Bouffant Cap	Tricot White 21" Bouffant Cap	-	Tricot	Non-ESD	21"



20 MIL

▲ 200-20001



8 MIL

▲ UPC

Reusable Aprons

Protection against liquid splash and incidental contact

200-20001

- High strength PVC layered material protects against liquid splashes and incidental contact
- Excellent resistance to chemicals, fats, oils and grease
- Excellent resistance to punctures and abrasion

UPC

- Excellent resistance to chemicals, fats, oils and grease
- Excellent resistance to punctures and abrasion
- Superior flexibility



▲ UVB-8HS

8 MIL

Reusable Sleeves

Offers extended protection against chemicals, fats, oils and grease

UVB-8HS

- Elastic at both ends for comfort
- Great for forearm coverage

Reusable Aprons and Sleeves

STYLE	ZI CFR	GARMENT	THICKNESS	CLOSURE	MATERIAL	COLOR	SIZES	PACKAGING	PROP 65
200-08001	Yes	Apron	8 mil	Tied Waist	Vinyl	White	35" x 45"	72/case	▲ C&R
200-12501	-	Apron	20 mil	Tied Waist	Neoprene	Black	35" x 45"	48/case	-
200-20001	Yes	Apron	20 mil	Tied Waist	Vinyl	White	35" x 45"	12/case	▲ C&R
UPB	Yes	Apron	8 mil	Tied Waist	Vinyl	Blue	35" x 45", 35" x 48", 35" x 55"	72/case	▲ C&R
UPC	Yes	Apron	8 mil	Tied Waist	Vinyl	Clear	35" x 45", 35" x 36"	72/case	▲ C&R
UPW	Yes	Apron	8 mil	Tied Waist	Vinyl	White	35" x 45", 35" x 48"	72/case	▲ C&R
UUB	Yes	Apron	6 mil	Tied Waist	Vinyl	Blue	35" x 45", 35" x 48", 35" x 50"	72/case	▲ C&R
UW-20	Yes	Apron	20 mil	Tied Waist	Vinyl	White	35" x 45"	36/case	▲ C&R
UVC-4HS	Yes	Sleeve	4 mil	Elastic	Vinyl	Clear	18"	144/case	▲ C&R
UVB-8HS	Yes	Sleeve	8 mil	Elastic	Vinyl	Blue	18"	144/case	▲ C&R

C = ▲ WARNING: Cancer - www.P65Warnings.ca.gov

R = ▲ WARNING: Reproductive Harm - www.P65Warnings.ca.gov

C&R = ▲ WARNING: Cancer and Reproductive Harm - www.P65Warnings.ca.gov



Scan it

Disposable Clothing



- 21 CFR Compliant
- Liquid-resistant yet breathable with high filtration efficiency
- Made from durable materials that aren't prone to shedding



C3802
Coverall

- Elastic wrist and ankles keep dirt and debris out
- Latex-free



C3818
Lab Coat

- Snap button front for quick donning
- Full-length coverage to thigh
- Latex-free



C3817
Shirt

- Snap button front for quick donning
- Professional collar



C3816
Pants

- Latex-free waist band for comfort
- Wide leg opening for easy donning
- Designed for a roomy fit



▲ **UBC-1000**



▲ **UB-1000**

Disposable Bouffants and Beard Covers

UBC-1000

- Elastic band for flexible fit
- Hair net available in a variety of sizes
- Lightweight nylon

UB-1000

- Elastic band for flexible fit
- Hair net available in a variety of sizes
- Lightweight polypropylene

Disposable Clothing

STYLE	21 CFR	GARMENT	CONFIGURATION	CLOSURE	MATERIAL	SEAM	COLOR	SIZES	PACKAGING
UB-1000	Yes	Bouffant	-	Elastic	Spunbond Polypropylene	-	White	18", 21", 24", 28"	1000/case
UBC-1000	Yes	Beard Cover	-	Elastic	Spunbond Polypropylene	-	White	18", 21"	1000/case
UC-1000	Yes	Bouffant	-	Elastic	Nylon	-	White	18", 21", 24", 28"	1000/case
UCBC-1000	Yes	Beard Cover	-	Elastic	Nylon	-	White	19"	1000/case
C3802	Yes	Coverall	Elastic Wrist & Ankle	Zipper	Spunbond Polypropylene Double Layer / Melt Blown Polypropylene Triple Layer	Serged	White	S-6XL	25/case
C3818	Yes	Lab Coat	-	Snap Front Closure	Spunbond Polypropylene Double Layer / Melt Blown Polypropylene Triple Layer	Serged	White	M-5XL	30/case
C3817	Yes	Shirt	-	Snap Front Closure	Spunbond Polypropylene Double Layer / Melt Blown Polypropylene Triple Layer	Serged	White	M-5XL	50/case
C3816	Yes	Pants	Elastic Waist	-	Spunbond Polypropylene Double Layer / Melt Blown Polypropylene Triple Layer	Serged	White	M-5XL	50/case



Hard Hats

Scan it



COLORS AVAILABLE



Dynamic® Whistler™ Hard Hat

280-HP241R

- Cap style hard hat with HDPE shell
- 4-point textile suspension
- Wheel ratchet adjustment



COLORS AVAILABLE



Dynamic® Bump Cap

280-HP940

- Lightweight ventilated HDPE shell
- 4-point pin lock suspension
- Does not meet or tested to any safety standards

Hard Hats

STYLE	CLASS	TYPE	ANSI Z89.1	CSA Z94.3-15	SHELL MATERIAL	SUSPENSION	SIZE ADJUSTMENT	BRIM	PROP 65
280-HP241R	Class E (NON-VENTED)	Type I	.	.	HDPE	4-Point Nylon	Wheel Ratchet	Standard	⚠️ C&R
280-HP940	-	-	-	-	HDPE	4-Point Nylon	Pin Lock	Standard	-

C = ⚠️ **WARNING:** Cancer - www.P65Warnings.ca.gov R = ⚠️ **WARNING:** Reproductive Harm - www.P65Warnings.ca.gov C&R = ⚠️ **WARNING:** Cancer and Reproductive Harm - www.P65Warnings.ca.gov

Eyewear



ZENON Z12™ Metal Detectable Rimless Safety Glasses FogLess® 3Sixty™

250-01-0520

- Special nylon temples are metal detectable and X-ray detectable
- Specifically designed to mitigate product loss risk in food processing and production facilities



Zenon Z12™ Extended Bridge Rimless Safety Glasses Anti-Scratch/Fog

250-01-0320

- Lightweight, rimless design provides all-day user comfort
- Thin, flexible temples provide a secure fit
- Meets ANSI Z87.1+ 2015 standards



Zenon Z11SM™ Rimless Safety Glasses Anti-Scratch

250-00-0900

- Lightweight, rimless design provides all-day user comfort
- Thin, flexible temples provide a secure fit
- Meets ANSI Z87.1+ 2015 standards



Zenon Z-LYTE II™ Rimless Safety Glasses Anti-Scratch/Fog

250-13-0020

- Modern wraparound lens style looks great on a variety of users
- Thin temple provides a secure fit
- Meets ANSI Z87.1+2015 standards

Eyewear

STYLE NUMBER	LENS	COATING	FRAME	STANDARDS MET		BASE CURVE	FIT	BRIDGE	TEMPLE	PROP 65
				ANSI Z87.1+	CSA Z94.3					
250-01-0520	Clear	FogLess® 3Sixty™	Blue	.	.	10	Universal	Molded	Spatula	⚠️ C&R
250-01-0553	Light Blue	FogLess® 3Sixty™	Blue	.	.	10	Universal	Molded	Spatula	⚠️ C&R
250-01-0020	Clear	FogLess® 3Sixty™	Blue	.	.	10	Universal	Molded	Spatula	⚠️ C&R
250-01-0053	Light Blue	FogLess® 3Sixty™	Blue	.	.	10	Universal	Molded	Spatula	⚠️ C&R
250-00-0900	Clear	Anti-Scratch	Clear	.	.	10	Narrow	Molded	Spatula	⚠️ C&R
250-01-0320	Clear	Anti-Scratch	Clear	.	.	9.5	Universal	Molded	Spatula	⚠️ C&R
250-13-0020	Clear	Anti-Scratch / Anti-Fog	Clear	.	.	10	Universal	Molded	Spatula	⚠️ C&R

C = ⚠️ **WARNING:** Cancer - www.P65Warnings.ca.gov R = ⚠️ **WARNING:** Reproductive Harm - www.P65Warnings.ca.gov C&R = ⚠️ **WARNING:** Cancer and Reproductive Harm - www.P65Warnings.ca.gov



Hearing Protection



Scan it



Headband

24
NRR



Dynamic® Spitfire™
263-NP111

- Dielectric headband reduces electrical hazards
- Smooth telescopic height adjustment for optimized comfort and seal
- Protection for moderate noise exposure

27
NRR



Dynamic® Hercules™
263-NP113

- Dielectric headband reduces electrical hazards
- Smooth telescopic height adjustment for optimized comfort and seal
- Protection for high noise exposure

Headbands

STYLE NUMBER	NRR	TYPE	DIELECTRIC	SIZE ADJUSTMENT	COLOR
270-NP111	24	Banded	Yes	Slide	Black/Blue
270-NP113	27	Banded	Yes	Slide	Black/Green

MAXIMUM HEARING PROTECTION



Metal Detectable Ear Plugs

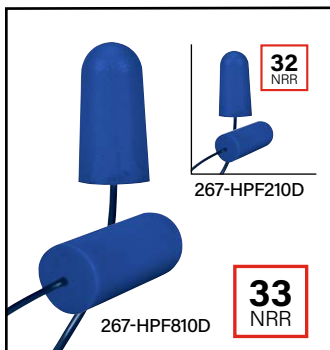

Tapered shape for easy insertion

Mega Bullet™ and Food Pro Bullet™ Plus

- Regular size fits most ear canals
- Easy roll-down for quick and easy insertion
- PowerSoft™ Foam Technology features a proprietary polyurethane formulation that delivers optimal recovery time, easy insertion and maximum all-day comfort
- Shape conforms to most ear canals for maximum sound attenuation
- For use in the food industry



Hybrid foam plug and unique stem enable easy insertion

EZ-Twist™

- No need to roll down before fitting, ideal for use with dirty hands
- PowerSoft™ Foam Technology features a proprietary polyurethane formulation that delivers optimal recovery time, easy insertion and maximum all-day comfort
- Shape conforms to most ear canals for maximum sound attenuation
- Traceable metal detectable (blue) style available for use in the food industry



Push-to-fit style reduces the risk of contamination

4-Flange Reusable

- Self-sealing 4 flange TPR (thermoplastic rubber) for all-day use and secure sound attenuation
- Corded version offers removable cord
- Metal detectable version offers metal infused ear plugs and cord for more detectability
- Metal detectable cord is NOT removable (used for food industry)



Smooth, dirt-repellent surface can be cleaned using soap and water, maintaining the wearer's comfort and safety

4-Flange Reusable

- Self-sealing 4-flange TPR (thermoplastic rubber) ear plug tips pivot to align with the ear canal for secure sound attenuation
- Ridged stem make insertion easy
- Cord can be detached for added safety when working around machines

Ear Plugs

STYLE NUMBER	NRR	USE	CORDING	MATERIAL	SIZE	SHAPE	COLOR	DETECTABLE	PAIR / PACK
267-HPF210D	32	Single	Blue Metal Detectable Cord	PowerSoft™ Polyurethane Foam	Standard	Bullet	Blue	Yes	100 / Box
267-HPF610D	30	Single	Blue Metal Detectable Cord	PowerSoft™ Polyurethane Foam	Standard	Cylinder Push-In	Blue	Yes	100 / Box
267-HPR410D	27	Reusable	Blue Metal Detectable Cord	TPR (thermoplastic rubber)	Standard	4-flange	Blue	Yes	100 / Box
267-HPR400D	27	Reusable	Orange Metal Detectable Cord	TPR (thermoplastic rubber)	Standard	4-flange	Orange	Yes	100 / Box
267-HPF810D	33	Single	Blue Metal Detectable Cord	PowerSoft™ Polyurethane Foam	Standard	Bullet	Blue	Yes	100 / Box
267-HPF910D	32	Single	Blue Metal Detectable Cord	PowerSoft™ Polyurethane Foam	Standard	Contoured	Blue	Yes	100 / Box



Scan it

Boss® Rubber and PVC Safety Boots



▲ 380-800



▲ 383-890



▲ 382-910

Cleaning / Power Washing /
Liquid and Chemical Splash

380-800

- Over-the-sock PVC construction
- Plain toe
- Energy-absorbing tread for all-day comfort

383-890

- Polyblend material offers superior resistance to oils and grease
- Steel toe and shank
- Lug outsole design provide comfort and slip resistance

382-910

- Over-the-sock PVC construction
- Steel toe
- Energy-absorbing tread for all-day comfort

Boss® Foot Protection

STYLE NUMBER	MATERIAL	LENGTH	COLOR	FEATURES			SIZES
				STEEL TOE	STEEL SHANK	TREAD PATTERN	
380-800	PVC	16"	Black			Cleated	6-14
383-890	-	16"	Black	•	•	Power-Lug	6-14
382-910	PVC	16"	White	•		Cleated	6-14

Liquid Splash Protection Kits

KIT 1



KIT 2



HACCP Cleaning / Sanitation / High-Pressure Washing / Alkaline and Acid Cleaning

Liquid Splash Protection Kits*

COMPONENTS					
KIT	PROTECTIVE CLOTHING	HARD HAT	BRACKET	FACE PROTECTION	FOOT PROTECTION
KIT 1	205-420CV	200-HP241R-01		251-60-0020 251-60-000V	380-800
KIT 2	205-375FR	200-HP241R-02	251-01-5270	251-01-5211	380-900

* All kit components are sold separately



Welding SAFETY

Find the right product for the job

Every day, welders face extreme environments complete with heat, sparks and slag. Choosing the right protection is essential to not only minimizing safety risks but maximizing worker productivity and the quality of the weld. When selecting hand protection, consider the application and environment to properly equip welders with gloves that are designed to meet the unique demands of welding.

Caiman® and Ironcat® welding gloves by PIP® are specifically designed for the various heat shielding, dexterity and protection demands of stick, MIG and TIG welding.

Stick

MAXIMUM HEAT PROTECTION AND DURABILITY

Gloves for stick welding are designed with thicker materials to withstand higher heat. The longer length provides better forearm coverage, while welts protect finger seams against sparks and abrasion. Various materials (split cowhide, elk), linings (cotton, foam insulation) and thumb designs (wing, straight, reinforced strap) are available to suit worker preferences.

MIG

ENHANCED DEXTERITY AND COMFORT

MIG welding gloves allow for maximum dexterity with an unlined palm, while foam insulation on the back of the hand provides increased heat protection. Various lightweight materials are available including cowhide for durability, goatskin for increased dexterity, deerskin for unparalleled comfort and pigskin, which stays pliable even with increased wear and exposure to moisture. Wing thumb designs for open-handed work are available, as are straight thumb designs for better grip. A reinforced thumb strap increases durability in high-wear areas.

TIG

EXTREME PRECISION AND DURABILITY

Constructed of lightweight materials, unlined TIG welding gloves allow for maximum dexterity. Goatskin provides durability and comfort, while kidskin offers unmatched dexterity. For a softer feel and comfort, deerskin gloves are the best option. Wing thumb designs ideal for open-handed work are also available in a straight thumb design for optimal torch grip.

Heat protecting technology

CLIMAX™ AEROGEL

Introducing the NEW, state-of-the-art aerospace technology that delivers maximum heat protection and comfort in welding gloves that's exclusive to PIP®. Originally created for panel lining on space shuttles, Climax™ Aerogel is a high-temperature heat shield, formed of a silica aerogel infused into a glass-fiber mat that does not burn or char - yet is hydrophobic, breathable, flexible and environmentally safe. Climax™ Aerogel withstands temperatures reaching over 3,600°F (2,000°C) and is featured in our premium gloves. Ironcat® gloves with Climax™ Aerogel offer advanced heat protection and comfort.

NOMEX®

Nomex® fiber has endured a rigorous series of fire scenarios that simulate real-life situations, making it one of the most advanced thermal burn injury prevention fabrics in the world. Nomex® is the go-to fabric for manufacturers that make products for protecting firefighters, air force pilots and industrial workers. For welders, this breathable fabric provides invaluable protection against flame.



Scan it



PREMIUM Stick / MIG Welding Gloves

The Revolution® Series offers a 3-dimensional, form-fitting design never before applied to welding gloves. The Revolution® Series has become known as the top-of-the-line, most premium welding gloves in the world.

From material selection to the attention to design details, Revolution® delivers unprecedented comfort, style and safety.

Revolution®, as the name suggests, is a complete departure from traditional welding gloves with minimal comfort, finger dexterity, or aesthetic value. Caiman® Revolution® gloves instantly set the bar higher and became the new standard for others to follow.

Industrial Fabrication / Infrastructure Construction / Shipbuilding / Railroads / Heavy-Duty Industrial



ANSI
A5



1507
CUT RESISTANT COW SPLIT PARA-ARAMID LINED MIG/STICK WELDING GLOVES
- Kontour™ form-fitting design
- Natural thumb design for proper ergonomic fit
- Reinforced palm and thumb for added durability
- Para-Aramid blend lining provides added cut and heat resistance



ANSI
A5



1521
CUT RESISTANT GOAT GRAIN WOOL PARA-ARAMID LINED MIG/STICK/PLASMA GLOVES
- Kontour™ form-fitting design
- Para-Aramid blend lining provides added cut and heat resistance
- Sewn with Kevlar® for maximum seam strength



ANSI
A5



1877
CUT RESISTANT 21" DEERSKIN PARA-ARAMID LINED STICK WELDING GLOVES
- Genuine leather heat shield patch, reinforced palm, cuff and lean-on patch
- Exclusive 3-dimensional, pre-curved fingers and form-fitting design for ultimate fit, comfort and dexterity
- Para-Aramid blend lining provides added cut and heat resistance



1832
GRAIN LEATHER FR FLEECE LINED WELDING GLOVES
- Kontour™ form-fitting design
- Wraparound index trigger patch, palm and lean-on patch
- Full-sock insulation with FR fleece and padded palm



1816
DEERSKIN FR FOAM FLEECE LINED WELDING GLOVES
- Kontour™ form-fitting design
- Patented double stitched palm padding and wear-patch
- Full-sock insulation with FR foam/fleece



1878
21" DEERSKIN FR INSULATED WELDING GLOVES
- Kontour™ form-fitting design
- Leather heat shield patch, reinforced palm, cuff and lean-on patch
- Sock-lined FR cotton fleece insulated

Premium Revolution® Series

STYLE NUMBER	HIDE	GRADE	STITCHING	COLOR	LINING	CUFF	SIZES
1507	Split Cowhide	Premium	Kevlar®	Blue / Charcoal	Para-Aramid blend	Gauntlet	OS
1521	Top Grain Goatskin / Split Cowhide	Premium	Kevlar®	Blue / Charcoal	Para-Aramid blend	Gauntlet	OS
1877	Deerskin	Premium	Kevlar®	Gold / Black	Para-Aramid blend	Scalloped	OS
1816	Split Deerskin	Premium	Kevlar®	Green / Gold	FR Foam Fleece	Gauntlet	M-XL
1832	Top Grain Goatskin	Premium	Kevlar®	Gold / Black	FR Fleece	Gauntlet	L-XL
1878	Deerskin / Split Cowhide	Premium	Kevlar®	Gold / Black	FR Cotton Fleece	Scalloped	L-XL, LHO



Premium Revolution® Series



1504
SPLIT COWHIDE FR COTTON LINED
WELDING GLOVES
- Kontour™ form-fitting design
- Thumb strap for added durability
- Sock-lined with fleece
for thermal protection



1506
SPLIT COWHIDE FLEECE LINED
WELDING GLOVES
- Kontour™ form-fitting design
- Reinforced palm and thumb
for added durability
- Sock-lined with fleece
for thermal protection



1508
18" SPLIT COWHIDE FLEECE LINED
WELDING GLOVES
- Kontour™ form-fitting design
- Reinforced palm and index area
for added durability
- Sock-lined with fleece
for thermal protection

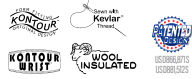

1512
SPLIT COWHIDE WOOL INSULATED BACK
WELDING GLOVES
- Kontour™ form-fitting design
- Kontour Wrist™ design to enhance
comfort and safety
- Wool lined for advanced
thermal protection

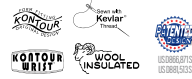

1520
GRAIN GOATSKIN WOOL INSULATED BACK
WELDING GLOVES
- Kontour™ form-fitting design
- Kontour Wrist™ design to enhance
comfort and safety
- Wool lined for advanced
thermal protection



1810
GRAIN COWHIDE UNLINED PALM WITH 2-LAYER
INSULATED BACK WELDING GLOVES
- Kontour™ form-fitting design
- Unlined, padded and reinforced palm
for added protection and comfort
- Two-layer insulated back for protection
against radiant heat



1812
GRAIN PIGSKIN FR COTTON FLEECE LINED
WELDING GLOVES
- Kontour™ form-fitting design
- Double layered protection features
lean-on and heat shield reinforcements
on the left hand
- Sock-lined FR cotton fleece insulated

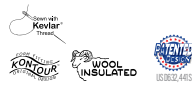

1852
DEERSKIN WOOL LINED WELDING GLOVES
- Kontour™ form-fitting design
- Thumb reinforcement strap,
pulse protector
- Wool lined for advanced
thermal protection



1879-5
21" PIGSKIN WELDING GLOVES WITH
HEAVY-DUTY TRIPLE LAYER CUFF
- Kontour™ form-fitting design
- Boarhide reinforcements
on palm and back provide
extra durability
- Triple-layer cuff for
heavy-duty protection

Premium Revolution® Series

STYLE NUMBER	HIDE	GRADE	STITCHING	COLOR	LINING	CUFF	SIZES
1504	Split Cowhide	Premium	Kevlar™	Gray / Black	Fleece	Gauntlet	One Size
1506	Split Cowhide	Premium	Kevlar™	Blue / Black	Fleece	Gauntlet	One Size
1508	Split Cowhide	Premium	Kevlar™	Blue / Black	Fleece	Gauntlet	One Size
1512	Split Cowhide	Premium	Kevlar™	Blue / Gold	Wool	Gauntlet	One Size
1520	Goatskin	Premium	Kevlar™	Blue / Black	Wool	Gauntlet	One Size
1810	Top Grain Cowhide	Premium	Kevlar™	Natural / Gold	Unlined Palm with Foam Fleece Back	Gauntlet	M-2XL
1812	Grain Pigskin	Premium	Kevlar™	Natural / Gold	FR Cotton Fleece	Gauntlet	L-XL
1852	Split Deerskin	Premium	Kevlar™	Black / Gold	Wool	Gauntlet	L-XL
1879-5	Pigskin / Sheep Skin	Premium	Kevlar™	Charcoal / Black	Foam Fleece	Triple Layer	L/XL



Industrial Grade



1434

GRAIN COWHIDE FLEECE LINED WELDING GLOVES

- Kontour™ form-fitting design
- Scalloped leather cuff provides additional forearm protection
- Sock-lined with fleece and internal padded palm for extra comfort



1440

SPLIT COWHIDE FOAM INSULATED WELDING GLOVES WITH REINFORCED PALM

- Kontour™ form-fitting design
- Reinforced supported palm and thumb for maximum wear and protection
- Aerofoam™ lining with full sock construction for unmatched comfort and insulation



1448

SPLIT COWHIDE ALUMINIZED WELDING GLOVES

- Kontour™ form-fitting design
- HeatFlect™ aluminized insulation reflects radiant heat
- Aerofoam™ lining with full sock construction for unmatched comfort and insulation



1449

18" SPLIT COWHIDE ALUMINIZED WELDING GLOVES

- Kontour™ form-fitting design
- HeatFlect™ aluminized insulation reflects radiant heat
- Aerofoam™ lining with full sock construction for unmatched comfort and insulation



1524

SPLIT COWHIDE ALUMINIZED BACK WELDING GLOVES

- Kontour™ form-fitting design
- Aluminized rayon back for radiant heat protection
- Wool lined for advanced thermal protection



1485

ELKSKIN UNLINED PALM WITH WOOL INSULATED BACK WELDING GLOVES

- Kontour™ form-fitting design
- Thumb reinforcement strap, pulse protector
- Wool lined for advanced thermal protection

Industrial Grade

STYLE NUMBER	HIDE	GRADE	STITCHING	COLOR	LINING	CUFF	SIZES
1434	Grain Cowhide	Premium	Kevlar™	Natural / Gold	Fleece	Scalloped	L-XL
1440	Split Cowhide	Premium	Kevlar™	Blue / Gold	Aerofoam™	Straight	One Size
1448	Split Cowhide	Premium	Kevlar™	Black / Gold	Aerofoam™ liner with HeatFlect™ insulation	Straight	One Size
1449	Split Cowhide	Premium	Kevlar™	Black / Gold	Aerofoam™ liner with HeatFlect™ insulation	Straight	One Size
1485	Grain Elkskin	Premium	Kevlar™	Gold / Gray	Wool	Gauntlet	M-XL
1524	Split Cowhide / Aluminized Back	Premium	Kevlar™	Blue / Black	Wool	Straight	One Size



MIG / TIG Welding Gloves

Aerospace / Automotive / Component Manufacturing /
Equipment Repair / Pipeline and Refinery



Scan it



1540
GRAIN GOATSKIN
UNLINED PADDED PALM
WELDING GLOVES
- Kontour™ form-fitting design
- Kontour Wrist™ design to
enhance comfort and safety
- Unlined padded palm
and index for comfort



1541
CUT RESISTANT GRAIN GOATSKIN
PADDED PALM WELDING GLOVES
- Kontour™ form-fitting design
- Padded palm & index for comfort
- Para-Aramid blend lining provides
added cut and heat resistance



1871
GRAIN GOATSKIN WOOL INSULATED
BACK WELDING GLOVES
- Kontour™ form-fitting design
- Boarhide™ palm patch for
extended wear and protection
- Unlined and padded palm
with wool insulated back

MIG / TIG

STYLE NUMBER	HIDE	GRADE	STITCHING	COLOR	LINING	CLIFF	SIZES
1540	Grain Goatskin	Premium	Kevlar™	Natural / Gold	Unlined with padded palm and FR Cotton back	Gauntlet	S-XL
1541	Grain Goatskin	Premium	Kevlar™	Natural / Gold	Para-Aramid blend	Gauntlet	S-XL
1871	Grain Goatskin	Premium	Kevlar™	White / Gold	Unlined with padded plam and Wool back	Scalloped	S-XL



1828
GRAIN COWHIDE
UNLINED PADDED PALM
WELDING GLOVES
- Kontour™ form-fitting design
- Patented double stitched palm padding and wear patch
- Unlined padded palm and thumb for added protection and comfort



1869
GRAIN GOATSKIN
UNLINED WELDING GLOVES
- Kontour™ form-fitting design
- Medium weight top grain goatskin leather for durability and comfort
- Unlined for maximum dexterity



1864
SPLIT DEERSKIN UNLINED WELDING GLOVES WITH LEAN-ON PATCH
- Kontour™ form-fitting design
- Large lean-on patch for extended protection and durability
- Unlined for maximum dexterity



1600
GRAIN GOATSKIN
UNLINED WELDING GLOVES
- Kontour™ Form Fitting Design
- Resilient and durable goatskin leather



1868
GRAIN GOATSKIN FR INSULATED BACK WELDING GLOVES
- Kontour™ form-fitting design
- Unlined, padded and reinforced palm and thumb saddle for added protection and comfort
- Flame resistant insulated back goatskin leather

ULTIMATE DEXTERITY AND COMFORT

MIG / TIG

STYLE NUMBER	HIDE	GRADE	STITCHING	COLOR	LINING	CLIFF	SIZES
1828	Grain Cowhide	Premium	Kevlar™	Natural / Gold	Unlined with padded palm and fleece back	Hook and Loop	M-XL
1869	Grain Goatskin	Premium	Kevlar™	Gold	Unlined	Gauntlet	S-XL
1864	Split Deerskin	Premium	Kevlar™	Gray / Black	Unlined	Gauntlet	S-XL
1600	Grain Goatskin	Premium	Kevlar™	Natural / Gold	Unlined	Gauntlet	S-XL
1868	Grain Goatskin	Premium	Kevlar™	Natural / Gold	Unlined with padded palm and FR Cotton back	Extended Gauntlet	S-XL



Multi-Task Work Gloves

Farm and Agriculture / Construction / Shipyards / Demolition



1302
TOP GRAIN COWHIDE LEATHER DRIVERS GLOVES
- Kontour™ form-fitting design
- Reinforced palm and index area for added durability
- Snap button closure to limit debris entry



1304
WATER-REPELLENT TOP GRAIN COWHIDE LEATHER DRIVERS GLOVES
- Kontour™ form-fitting design
- Reinforced palm and index area for added durability
- Snap button closure to limit debris entry



1306
ELK GRAIN LEATHER DRIVERS GLOVES
- Kontour™ form-fitting design
- Reinforced palm and index area for added durability
- Snap button closure to limit debris entry

General Work

STYLE NUMBER	HIDE	GRADE	STITCHING	COLOR	LINING	CLIFF	SIZES
1302	Top Grain Cowhide Palm / Split Leather Back	Premium	Nylon	White / Blue	Unlined with reinforced plam	Slip-On with pull-strap & elastic	S-2XL
1304	Top Grain Cowhide - Water Repellent	Premium	Nylon	Gold	Unlined with reinforced plam	Slip-On with pull-strap & elastic	S-XL
1306	Genuine Elk Grain	Premium	Nylon	Gold	Unlined with reinforced plam	Slip-On with pull-strap & elastic	S-XL



Scan it

Welding Accessories



Welding Blankets



69661

SILKGLASS™ WELDING BLANKET

- Extra soft and pliable to easily conform to equipment or work environment
- Withstands temperatures over 1000°F (538°C)

STYLE NUMBER	FABRIC	WEIGHT	COLORS	SIZES
69661	Silkglass™	26 oz.	White	6' x 6'
69662	Silkglass™	52 oz.	White	6' x 6'
69682	Silkglass™	26 oz.	White	6' x 8'

Electrode Holder



3250

BOARHIDE™ ELECTRODE HOLDER

- Reinforced bottom
- Spring clip
- Belt Loop

STYLE NUMBER	FABRIC	THREAD	COLORS	SIZES
3250	Pigskin	Kevlar™	Gold	One Size

Gear Bag



66980

WATERPROOF GEAR BAG

- Waterproof heavy-duty ballistic nylon material with double-stitched handles for durability
- 13 external pockets and 10 internal pockets offer plenty of storage to hold your tools

STYLE NUMBER	FABRIC	POCKETS	COLORS	SIZES
66980	Waterproof Nylon	13	Black	One Size

Leather Cover Mitt



1879-1

LEATHER COVER MITT

- Durable Boarhide™ provides exceptional abrasion, heat and puncture resistance due to its natural characteristics
- Can be used on left or right hand

STYLE NUMBER	FABRIC	THREAD	COLORS	SIZES
1879-1	Pigskin	Kevlar™	Gray	One Size



Scan it



Stick Welding

MAXIMUM HEAT PROTECTION
AND DURABILITY

Farm and Agriculture / Structural / Heavy Industrial /
Mining / Industrial Fabrication



KEVLAR® THREAD



9070
PREMIUM GOATSKIN/COWHIDE
GLOVES
- Climax™ aerogel insulation
- Precurved fingers
- Kevlar® thread



KEVLAR® THREAD



9060
PREMIUM ELKSKIN STICK
WELDING GLOVES
- Premium top grain elk
- Reinforced straight thumb
- Foam and cotton lining
- Also available in gray (9061)



CUT RESISTANT LINER



946
CUT RESISTANT COWHIDE
WELDING GLOVES
- Premium split cowhide
- Reinforced thumb
- Para-Aramid lining
- ARC Rating: ATPV 63 cal/cm²



KEVLAR® THREAD



9051
PREMIUM COWHIDE
STICK WELDING GLOVES
- Premium split cowhide
- Double reinforced
wing thumb
- Foam and cotton lining



KEVLAR® THREAD



9050
PREMIUM COWHIDE
STICK WELDING GLOVES
- Premium split cowhide
- Double reinforced
wing thumb
- Foam and cotton lining



KEVLAR® THREAD



73-7150
PREMIUM COWHIDE
STICK WELDING GLOVES
- Premium split cowhide
- Double reinforced
wing thumb
- Foam and cotton lining

Premium Leather

STYLE	HIDE	GRADE	STITCHING	COATING COLOR	LINER	CUFF	REINFORCED THUMB	SIZES
9070	Goatskin	Premium	Kevlar®	Brown	Climax™ Aerogel	Gauntlet	No	M-2XL (Left Hand)
9060	Elkskin	Premium	Kevlar®	Yellow	Unlined	Split Cowhide Gauntlet	Yes	S-XL
9061	Elkskin	Premium	Kevlar®	Gray	Unlined	Split Cowhide Gauntlet	Yes	S-XL
946	Split Cowhide	Premium	Kevlar®	Blue	Para-Aramid	Straight	Yes	S-2XL
9051	Split Cowhide	Premium	Kevlar®	Blue	Cotton Foam	Straight	Yes	M-XL (Left Hand)
9050	Split Cowhide	Premium	Kevlar®	Blue	Cotton Foam	Straight	Yes	L (Left Hand)
73-7150	Split Cowhide	Side Split	Kevlar®	Brown	Cotton Foam	Straight	Yes	L



2086GLF
- Premium split cowhide
- Reinforced straight thumb
- Cotton lining



9040
- Select shoulder split cowhide
- Reinforced wing thumb
- Foam and cotton lining



9012L
- Select shoulder split cowhide
- Reinforced wing thumb
- Foam and cotton lining



9041
- Select shoulder split cowhide
- Reinforced wing thumb
- Foam and cotton lining



9020
- Select shoulder split cowhide
- Reinforced straight thumb
- Cotton lining



9401
- Select shoulder split cowhide
- Straight thumb
- Cotton lining



945
- Premium split cowhide
- Reinforced wing thumb
- Cotton lining



9400
- Premium split cowhide
- Reinforced straight thumb
- Cotton lining



9010
- Standard shoulder split cowhide
- Wing thumb
- Cotton lining



73-7088
- Standard split cowhide
- Wing thumb
- Cotton lining



940R
- Standard split cowhide
- Wing thumb
- Cotton lining



930K
- Standard split cowhide
- Wing thumb
- Cotton lining

Standard Leather

STYLE	HIDE	GRADE	STITCHING	COATING COLOR	LINER	CUFF	REINFORCED THUMB	SIZES
2086GLF	Split Cowhide	Premium	Kevlar [®]	Rust	Cotton	Split Cowhide Gauntlet	Yes	L
9040	Split Cowhide	Select Shoulder	Kevlar [®]	Gold	Cotton Foam	Straight	Yes	L (Left Hand)
9012L	Split Cowhide	Shoulder	Kevlar [®]	Blue	Cotton Foam	Straight	No	Ladies
9041	Split Cowhide	Shoulder	Kevlar [®]	Blue	Cotton Foam	Straight	Yes	L (Left Hand)
9020	Split Cowhide	Premium	Kevlar [®]	Brown	Cotton	Straight	Yes	L (Left Hand)
9401	Split Cowhide	Select Shoulder	Kevlar [®]	Gold	Cotton	Straight	Yes	L
945	Split Cowhide	Premium	Kevlar [®]	Blue	Cotton	Straight	Yes	L-XL (Left Hand)
9400	Split Cowhide	Select Shoulder	Kevlar [®]	Red	Cotton	Straight	Yes	L

Engineered Value

STYLE	HIDE	GRADE	STITCHING	COATING COLOR	LINER	CUFF	REINFORCED THUMB	SIZES
9010	Split Cowhide	Shoulder	Nylon	Gray	Cotton	Straight	No	L (Left Hand)
73-7088	Split Cowhide	Shoulder	Nylon	Golden Brown	Cotton	Straight	No	L
940R	Split Cowhide	Shoulder	Nylon	Red	Cotton	Straight	No	L
930K	Split Cowhide	Shoulder	Kevlar [®]	Gray	Cotton	Straight	No	L



Scan it



MIG Welding

ENHANCED DEXTERITY
AND COMFORT

Tack Welding / Automotive / Industrial Repair /
Structural / Heavy-Duty Repair



9072

PREMIUM GOATSKIN
MIG WELDING GLOVES
- Premium split goatskin
- 8" cuff for added protection
- Climax™ Aerogel insulation



9071

PREMIUM GOATSKIN
MIG WELDING GLOVES
- Premium split goatskin
- 4" cuff
- Reinforced palm



6143

PREMIUM GOATSKIN/COWHIDE
GLOVES
- Premium grain goatskin palm
- Reinforced straight thumb
- Fleeced lined



6010

PREMIUM COWHIDE
MIG WELDING GLOVES
- Premium top grain cowhide
- Wing thumb
- 4" cuff



6030

PREMIUM DEERSKIN
MIG WELDING GLOVES
- Top grain reverse deerskin
- Reinforced straight thumb
- 4" cuff



6021

PREMIUM PIGSKIN
MIG WELDING GLOVES
- Top grain pigskin
- Straight thumb
- Foam lined back of hand



6000

STANDARD COWHIDE
MIG WELDING GLOVES
- Standard top grain cowhide
- Wing thumb
- 4" cuff



ANSI

A4

2

PPE

6243

CUT RESISTANT GRAIN GOATSKIN
MIG WELDING GLOVES
- Smooth top grain goatskin leather
- Fleece-lined for additional
heat protection
- Cut resistant Para-Aramid liner
- ARC Rating: ATPV 20 cal/cm²



ANSI

A4

3

PPE

6040

CUT RESISTANT COWHIDE
MIG WELDING GLOVES
- Top grain cowhide
- Wing thumb
- Para-Aramid lined for added
cut and heat resistance
- ARC Rating: ATPV 34 cal/cm²

Premium Leather

STYLE	HIDE	GRADE	STITCHING	COATING COLOR	LINER	CUFF	REINFORCED THUMB	SIZES
9072	Top Grain Goatskin	Premium	Kevlar [®]	Gray	Climax™ Aerogel	Split Cowhide Gauntlet	No	M-2XL
9071	Top Split Goatskin	Premium	Kevlar [®]	Gray	Unlined	Split Leather Band Top	No	M-2XL
6143	Top Grain Goatskin	Premium	Kevlar [®]	Golden Brown	Fleeced	Split Cowhide Gauntlet	Yes	M-XL
6010	Top Grain Cowhide	Premium	Kevlar [®]	Natural	Unlined	Split Cowhide Gauntlet	No	S-XL
6030	Reverse Split Deerskin	Premium	Kevlar [®]	Gold	Cotton Foam	Split Cowhide Gauntlet	Yes	M-XL
6021	Top Grain Pigskin	Premium	Kevlar [®]	Natural	Unlined	Split Cowhide Gauntlet	No	S-XL
6243	Top Grain Goatskin	Premium	Kevlar [®]	Brown	Para-Aramid blend	Split Cowhide Gauntlet	No	S-2XL
6040	Top Grain Cowhide	Premium	Kevlar [®]	Natural	Para-Aramid blend	Split Cowhide Gauntlet	No	S-2XL

Standard Leather

STYLE	HIDE	GRADE	STITCHING	COATING COLOR	LINER	CUFF	REINFORCED THUMB	SIZES
6000	Top Grain Cowhide	Standard	Kevlar [®]	Beige	Unlined	Split Cowhide Gauntlet	No	S-XL



Scan it



TIG Welding

EXTREME PRECISION
AND DURABILITY

Aerospace / Automotive / Art / Component Manufacturing /
Food Processing Equipment / Pipeline and Refinery



6144
CUT RESISTANT GRAIN KIDSKIN
WELDING GLOVES
- Premium top grain goatskin
- Kevlar® liner
- ANSI puncture 3
- ARC Rating: ATPV 36 cal/cm²



9073
PREMIUM GOATSKIN
TIG WELDING GLOVES
- Premium grain goatskin
- Nomex™ back of hand
- Snug elastic wrist



6130
PREMIUM DEERSKIN
TIG WELDING GLOVES
- Premium deerskin split
leather
- Straight thumb
- 4" cuff



6141
PREMIUM KIDSKIN
TIG WELDING GLOVES
- Premium top grain kidskin
- Straight thumb
- 4" cuff



6140
PREMIUM KIDSKIN
TIG WELDING GLOVES
- Premium top grain kidskin
- Straight thumb
- 2" cuff



6142
PREMIUM GOATSKIN
TIG WELDING GLOVES
- Premium top grain goatskin
- Wing thumb
- 4" cuff



75-4904
TOP GRAIN GOATSKIN
WELDING GLOVES
- Premium top grain goatskin
- Straight thumb
- Slip-on cuff



6100
METAL TAMER™ SILICONE
COATED GLOVES
- Cut resistant Kevlar®/wool shell
- Heat resistant palm
- ARC rating: ATPV 6.9 cal/cm²



6244
CUT RESISTANT GOATSKIN
WELDING GLOVES
- Premium grain goatskin
- Cut resistant para-aramid liner
- High heat impact protection
- ARC Rating: ATPV 37 cal/cm²
- Heat resistant up to 572° F

Premium Leather

STYLE	HIDE	GRADE	STITCHING	COATING COLOR	LINER	CUFF	REINFORCED THUMB	SIZES
6144	Top Grain Kidskin	Premium	Kevlar®	White	Kevlar®	Split Cowhide Gauntlet	No	M-2XL
9073	Top Grain Goatskin	Premium	Kevlar®	Black	Nomex® Back	Split Cowhide Gauntlet	No	M-2XL
6130	Split Deerskin	Premium	Kevlar®	Gray	Unlined	Split Cowhide Gauntlet	Yes	M-XL
6141	Top Grain Kidskin	Premium	Kevlar®	White	Unlined	Split Cowhide Gauntlet	No	S-XL
6140	Top Grain Kidskin	Premium	Kevlar®	White	Unlined	2" Split Cowhide Gauntlet	Yes	M-XL
6244	Top Grain Goatskin	Premium	Kevlar®	White	Para-Aramid	Split Cowhide Gauntlet	No	S-3XL

Standard Leather

STYLE	HIDE	GRADE	STITCHING	COATING COLOR	LINER	CUFF	REINFORCED THUMB	SIZES
6142	Top Grain Goatskin	Premium	Kevlar®	White	Unlined	Split Cowhide Gauntlet	No	M-XL
75-4904	Top Grain Goatskin	Premium	Kevlar®	Gray	Unlined	Goatskin Band Top Cuff	No	S-XL

Specialty

STYLE	COATING	COATING COVERAGE	COATING COLOR	GRIP	ANSI CUT	LINER MATERIAL	LINER COLOR	CUFF	SIZES
6100	FR Silicone	Palm and Fingers	Gray	Dot	A3	FR Blended	Green	Knit Wrist	S-2XL



Scan it



Work Gloves

PERFORMANCE
AND ENDURANCE

Farm and Agriculture / Construction /
Shipyards / Demolition



ANSI
A3



- 9076**
- Premium water buffalo and cowhide
 - Dorsal impact protection
 - Kevlar® lining



ANSI
A3



- 86552**
- Heavy-duty top grain goatskin
 - 4-way stretch spandex back
 - 360° Kevlar® lining



- 86555**
- Heavy-duty top grain goatskin
 - 4-way stretch spandex back
 - Reinforced palm, thumb saddle and fingertips



- 86400**
- Premium grade deerskin
 - 4-way stretch spandex back
 - Hook and loop closure



- 86550**
- Heavy-duty top grain goatskin
 - 4-way stretch spandex back
 - Reinforced palm, thumb saddle and fingertips



- 9414**
- Top grain cowhide palm
 - Split cowhide back of hand
 - Keystone thumb



- 9075**
- Premium water buffalo and cowhide
 - Dorsal impact protection
 - Kevlar® thread



- 9420**
- Top grain cowhide driver
 - Keystone thumb
 - Snug elastic wrist



- 86350**
- Premium grain cowhide
 - 4-way stretch spandex back
 - Reinforced palm, thumb saddle and fingertips



- 9074**
- Premium water buffalo and cowhide
 - Dorsal impact protection
 - Hi-vis green Spandex on back of hand



- 86355**
- Premium water buffalo and cowhide
 - Winter insulation
 - Reinforced palm, thumb saddle and fingertips



- 9405**
- Heavy-duty grain pigskin
 - Keystone thumb
 - Snug elastic wrist

Premium Leather

STYLE	HIDE	BACK	LINER	ANSI CUT	CLIFF	COATING COLOR	SIZES
9076	Buffalo Leather	Split Cowhide Leather	Kevlar®	A3	Slip-On	Gray/White	S-2XL
86552	Goatskin Leather	Spandex	Kevlar®	A3	Slip-On with Hook & Loop	Black/White	S-3XL
86555	Goatskin Leather	Spandex	Unlined	-	Slip-On with Hook & Loop	Black/Gold/White	S-2XL
86400	Deerskin Leather	Spandex	Unlined	-	Slip-On with Hook & Loop	Black/Gold	M-2XL
86550	Goatskin Leather	Spandex	Unlined	-	Slip-On with Hook & Loop	Black/White	S-2XL
9414	Grain Cowhide Leather	Split Cowhide Leather	Unlined	-	Slip-On	Brown/White	S-3XL

Standard Leather

STYLE	HIDE	BACK	LINER	ANSI CUT	CLIFF	COATING COLOR	SIZES
9075	Buffalo Leather	Split Cowhide Leather	Unlined	-	Slip-On	White	S-2XL
9420	Grain Cowhide Leather	Grain Cowhide Leather	Unlined	-	Slip-On	White	S-3XL
86350	Cowhide Leather	Spandex	Unlined	-	Slip-On with Hook & Loop	Black/Gold	S-3XL
9074	Buffalo Leather	Fabric	Unlined	-	Slip-On	Hi-Vis Green/White	M-2XL
86355	Grain Pigskin	Spandex	3M™ Thinsulate™	-	Slip-On with Hook & Loop	Black/Beige	S-3XL
9405	Split Cowhide Leather	Split Cowhide Leather	Unlined	-	Slip-On	Brown	S-3XL



ANSI A4 **4 PPE**

KS992K

- Top grain cowhide
- Kevlar® liner provides excellent cut resistance
- ARC rating: ATPV 43 cal/cm²
- ANSI puncture 3



ANSI A4 **4 PPE**

KS993KOA

- Treated with Oil Armor™ and Aqua Armor®
- ARC rating: ATPV 43 cal/cm²
- ANSI puncture 5



ANSI A4 **4 PPE**

KS993KOAB

- High cut and puncture resistance
- Water and oil resistant
- ARC rating: ATPV 43 cal/cm²



ANSI A5 **4 PPE**

09-LC533AR

- Top grain goatskin
- Para-Aramid liner provides excellent cut resistance
- ARC rating: ATPV 44 cal/cm²



ANSI A4 **3 PPE**

9444

- Top grain cowhide
- Para-Aramid liner provides cut and heat resistance
- ARC rating: 27 cal/cm²



ANSI A4

43-850

- Kevlar®/Preox blended shell
- Seamless construction offers increased comfort and breathability

HEAT HANDLING



ANSI A4

43-858

- Kevlar®/Preox blend shell provides excellent cut, abrasion and thermal protection

HEAT HANDLING



43-802

- EverGrip™ coating is a specially formulated nitrile that resists melting

HEAT HANDLING



5500
ALUMINIZED BACK OF HAND
WELDING PAD

- Flexible, form fitting
- Double layer protection
- Elastic and Kelvar® strap

Specialty Leather

STYLE	ANSI CUT	EN388	ANSI/ISEA 138	HIDE	GRADE	STITCHING	COLOR	LINING	CLIFF	SIZES
09-LC533AR	A5	2X32E	-	Grain Goatskin Leather	Premium	Kevlar®	Natural	Para-Aramid	Slip-On	S-3XL
KS992K	A4	2432D	-	Grain Cowhide Leather	Premium	Kevlar®	Natural	Para-Aramid	Slip-On	S-3XL
KS993KOA	A4	2524D	-	Grain Goatskin Leather	Premium	Kevlar®	Brown	Para-Aramid	Slip-On	S-3XL
KS993KOAB	A4	2524D	Impact Level 2	Grain Goatskin Leather	Premium	Kevlar®	Brown	Para-Aramid	Slip-On	S-3XL
9444	A4	-	-	Grain Cowhide Leather	Premium	---	Brown	Para-Aramid	Slip-On	S-3XL

Heat Accessories

STYLE	MATERIAL	SIZE	SIZES
5500	Aluminized Fiberglass	7.5" x 5.5"	OS

Heat Handling

STYLE	COATING	COATING COVERAGE	COATING COLOR	LINER MATERIAL	LINER COLOR	CONSTRUCTION	CLIFF	WEIGHT	SIZES
43-850	Uncoated	Uncoated	Green	Kevlar®/Preox Blend, Terry Cotton Lined	Green	Coated Double-Layered Seamless Knit	Open	32 oz.	S, L
43-858	Uncoated	Uncoated	Green	Kevlar®/Preox Blend, Terry Cotton Lined	Green	Coated Double-Layered Seamless Knit	Open	32 oz.	S, L, XL
43-802	EverGrip™ Nitrile	Single-Sided	Rust	100% Cotton	Natural	Coated Double-Layered Seamless Knit	Open	32 oz.	S, L



Impact Protection Gloves



Scan it



16-MP785
- 18-gauge shell has excellent dexterity and tactile sensitivity
- Neofoam® coating
- Knuckle and dorsal guards for medium-duty impact protection



16-MP585
- 18-gauge shell has excellent dexterity and tactile sensitivity
- NeoFoam® coating
- Knuckle and dorsal guards for medium-duty impact protection



9916
- Top grain goatskin
- Kevlar® blended liner provides superior cut protection
- Knuckle and dorsal guards for medium-duty impact protection



9120
- Sheepskin leather is soft and durable
- Aramid-blended liner provides excellent cut resistance
- Knuckle and dorsal guards for maximum back-of-hand impact protection

Cut & Abrasion Resistant



09-K1600
- Resistant to light heat and spark
- Handling heavy sharp parts in oily environments



09-K1630
- Kevlar® blended shell provides excellent cut protection
- Foam nitrile coating provides good grip and excellent abrasion resistance



713KSSN
- Aramid blended shell provides resistance to low heat and spark
- ARC rating: ATPV 4.4 cal/cm²



09-K1310
- Kevlar® fiber shell provides cut resistance and heat protection
- Crinkle latex coating provides superior grip in wet/dry conditions

Impact Protection

STYLE	ANSI CUT	EN388	ANSI/ISEA 138	COATING	COATING COVERAGE	COATING COLOR	LINER MATERIAL	LINER COLOR	GAUGE	SIZES
16-MP785	A7	4X43FP	Impact Level 1	NeoFoam® MicroSurface	Palm & Fingers	Black	PolyKor™ XT	Black	18	M-2XL
16-MP585	A5	4X42EP	Impact Level 1	NeoFoam®	Palm & Fingers	Black	PolyKor™	Blue	18	M-2XL
9916	A7	---	Impact Level 1	Grain Goatskin Leather	Full Hand	Natural	Kevlar® Blend	Yellow	---	S-3XL
9120	A4	---	Impact Level 2	Grain Sheepskin Leather	Full Hand	Natural	Aramid Blended	Yellow	---	S-3XL
997KB	---	2132	Impact Level 2	Grain Cowhide Leather	Full Hand	White	Unlined	---	---	XS-3XL

Cut & Abrasion Resistant

STYLE	ANSI CUT	EN388	COATING	COATING COVERAGE	COATING COLOR	LINER MATERIAL	LINER COLOR	GAUGE	SIZES
09-K1600	A7	4532FX	Nitrile Foam	Palm & Fingers	Black	Kevlar®	Yellow	13	S-3XL
09-K1630	A4	4X31D	Nitrile Foam	Palm & Fingers	Black	Kevlar®	Gray	13	S-2XL
09-K1310	A3	2444C	Crinkle Latex	Palm & Fingers	Blue	Kevlar®	Yellow	10	S-XL
09-K1600	A7	4532F	Nitrile Foam	Palm & Fingers	Black	Kevlar®	Yellow	13	S-3XL
713KSSN	A6	4542F	Nitrile Foam	Palm & Fingers	Green	Aramid/Stainless Steel	Green	13	XS-3XL



Caiman® FR Apparel

Scan it

Soft and pliable FR (Flame Resistant) 100% treated 9 oz. cotton fabric combined with functional features to enhance safety and comfort. Caiman® FR garments are tailored to address obvious complaints of traditional, starchy green FR garments. Affordable, functional and stylish...No need to ever go back.

Jacket

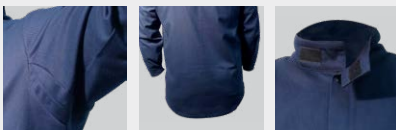

UNDERARM GUSSET
EXPANSION

EXTENDED
BOTTOM

ADJUSTABLE
RAISED BACK
STAND UP COLLAR

3000

9 OZ. FR COTTON JACKET

- Extended tail for added coverage and protection
- Stand up collar with raised back
- Underarm gussets for added mobility and reach

Jacket

STYLENUMBER	FABRIC	GRADE	WEIGHT	COLOR	SIZES
3000	Flame-Resistant Cotton	Premium	9 oz.	Navy	S-5XL

Apron



3002

36" 9 OZ. FR COTTON APRON

- Adjustable Comfort-Strap™ ensures a proper fit regardless of size or preference
- Large 2 compartment chest pocket

Apron

STYLENUMBER	FABRIC	GRADE	WEIGHT	POCKETS	COLOR	SIZES
3002	Flame-Resistant Cotton	Premium	9 oz.	2	Navy	36"

Sleeves



3004

18" 9 OZ. FR COTTON SLEEVES

- 9 oz. flame-resistant cotton — effective up to 100 washes
- Elastic top with snap-wrist buttons

Sleeves

STYLENUMBER	FABRIC	GRADE	WEIGHT	CUFF	COLOR	SIZES
3004	Flame-Resistant Cotton	Premium	9 oz.	Snap Button	Navy	18"



Leather Apparel

Scan it

Protective clothing is made of premium quality split pigskin leather. Boarhide® is 15 to 25% lighter, stays cleaner, more breathable and offers better cut, abrasion and heat resistant values than split cowhide leather of equal thickness. Also, unlike split cowhide leather, Boarhide® is naturally elastic which provides enhanced mobility.

Bib Aprons



3136

36" BOARHIDE® BIB APRON

- Offers greater mobility than cowhide
- Wide adjustable neck and waist straps

3142 - 42" bib apron

3148 - 48" bib apron

Split Leg Aprons



3242

42" BOARHIDE® SPLIT LEG BIB APRON

- Offers greater mobility than cowhide
- Wide adjustable shoulder and waist straps
- Bib pocket

3248 - 48" apron

Chaps



3240

40" BOARHIDE® CHAPS

- Offers greater mobility than cowhide
- Wide adjustable waist and leg straps

Bib Aprons

STYLE NUMBER	FABRIC	GRADE	COLORS	SIZES
3136	Pigskin Leather	Premium	Gold	36"
3142	Pigskin Leather	Premium	Gold	42"
3148	Pigskin Leather	Premium	Gold	48"

Split Leg Aprons

STYLE NUMBER	FABRIC	GRADE	COLORS	SIZES
3242	Pigskin Leather	Premium	Gold	42"
3248	Pigskin Leather	Premium	Gold	48"
Chaps				
3240	Pigskin Leather	Premium	Gold	24" x 40"



Jackets



3030

30\"/>

- Offers greater mobility than cowhide
- Satin lined shoulders and sleeves for enhanced comfort
- Vented back and underarms for increased breathability

3029

30\"/>

Cape Sleeves



3031

BOARHIDE\"/>

- Offers greater mobility than cowhide
- Satin lined shoulders and sleeves for enhanced comfort
- Corduroy lined collar for comfort

8051

COMBINATION FR COTTON / LEATHER CAPE SLEEVE WITH APRON

- Inherently flame resistant proban cotton for lightweight protection
- Leather reinforced snaps prevent flashback
- Custom apron included for each size XS-8XL
- NFPA 2112, NFPA 70E PPE2, ASTM F1959 and ASTM F1506 compliant

Replacement Bib



3032

18\"/>

- Offers greater mobility than cowhide
- Attaches to 3031 Boarhide® cape sleeve

Sleeves



3123

23\"/>

- Offers greater mobility than cowhide
- Adjustable wrist snaps for overhead welding
- Adjustable neck straps with quick-release plastic buckle

Jackets

STYLE NUMBER	FABRIC	GRADE	CLIFF	COLORS	SIZES
3029	Pigskin Leather	Premium	-	Black	S-3XL
3030	Pigskin Leather	Premium	-	Gold	S-5XL
Cape Sleeves					
3031	Pigskin Leather	Premium	-	Gold	M-3XL
8051	Split Cowhide	Premium	-	Black/Gold	XS-8XL

Replacement Bib

STYLE NUMBER	FABRIC	GRADE	CLIFF	COLORS	SIZES
3032	Pigskin Leather	Premium	-	Gold	18"
Sleeves					
3123	Pigskin Leather	Premium	Snap Button	Black	23"



Scan it



Welding Sleeves

EXTENDED
ARM PROTECTION

Tack Welding / Automotive / Table Cutting /
Tooling / Aerospace / Component Manufacturing



7070 | 7071

IRONCAT® FR TREATED SATEEN COTTON SLEEVES

- FR treated 9 oz. green 100% cotton sateen fabric offers protection in low heat and light spark applications
- Blousy fit protects from open flame and high heat applications
- Available lengths: 18" or 23"



7020

IRONCAT® PREMIUM SPLIT LEATHER SLEEVES

- Constructed of specially tanned split leather for heat resistance and protection from sparks
- Stitched with Kevlar® adding strength and burn resistance
- Anodized snaps reinforced with leather do not corrode and prevent flashback



10-K46

KUT GARD® VISCOSE / KEVLAR® BLENDED SLEEVE

- Excellent thermal and flame protection
- Offers cut resistance for light-duty applications
- Exceptionally comfortable, lightweight, breathable and shrink resistant



10-KA

KUT GARD® ACP / KEVLAR® BLENDED SLEEVE

- Heat resistance protects the arm from minor heat and burn injuries up to 350°F
- Offers twice the cut resistance compared to traditional Para-Aramid sleeves



Welding Sleeves

STYLE	FABRIC	GRADE	ANSI CUT	WEIGHT	COLOR	CUFF	SIZES
7070	FR Treated Sateen Cotton	Premium	---	9 oz.	Green	2" Elastic	18" & 23"
7071	FR Treated Sateen Cotton	Premium	---	9 oz.	Green	3/4" Elastic	18" & 23"
7042	FR Treated Cotton Twill	Standard	---	9 oz.	Green	2" Elastic	18"
7041	FR Treated Cotton Twill	Standard	---	9 oz.	Green	3/4" Elastic	18"
7020	Split Cowhide Leather	Premium	---	---	Brown	Adjustable Buckle and Snaps	18"
10-K46	Viscose/Kevlar® Blended	Premium	A2	---	Brown/Yellow	Elastic with Thumb Hole	22" & 26"
10-KA	ACP™/Kevlar® Blended	Premium	A5	---	Green	Straight	10", 12", 14", 16", 18", 20" & 24"



Scan it



Welding Apparel

TAILORED FOR DIFFERENT TYPES
OF WELDING

Stick Welding / TIG Welding / MIG Welding



WELDING JACKETS



7005
Ironcat® Heat Resistant Leather Jacket



7040
Ironcat® FR Cotton Jacket



7060
Ironcat® Irontex™ Cotton Sateen Jacket

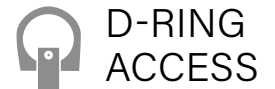

Ironcat® Irontex™ FR Treated Cotton Sateen Jacket 7050

- FR treated 9 oz. green 100% cotton sateen fabric protects from sparks
- Anodized snaps with leather reinforcement do not corrode and prevent flashback
- Black pop-up welders collar with snap closure
- Scribe/soapstone pocket on left sleeve and 1 interior lower pocket
- ASTM D6413 Compliant
- 100 home washing or 50 commercial washings

AVAILABLE COLORS



Welding Jackets

STYLE	FABRIC	GRADE	WEIGHT	COLORS	SIZES
7005	Split Cowhide Leather	Premium	---	Brown	M-3XL
7050	FR Treated Sateen Cotton	Premium	9 oz.	Green, Black, Navy, Royal Blue, Red, Orange	S-5XL
7060	FR Treated Sateen Cotton	Premium	9 oz.	Orange	S-6XL
7040	FR Treated Cotton Twill	Standard	9 oz.	Green	M-5XL



WELDING APRONS



7010
Ironcat® Bib Apron



7011
Ironcat® Split Apron



7012
Ironcat® Waist Apron



7080
Ironcat® FR Cotton Sateen Apron



SLEEVES AND BIBS



7000
Cape Sleeve

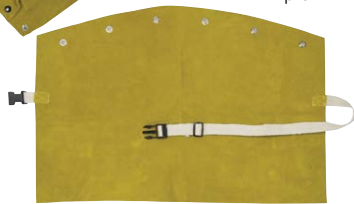

7001
Apron

Ironcat® Split Leather Cape Sleeve & Bib 7000 | 7001

- Heat resistant split cowhide with Kevlar® thread
- Anodized and leather reinforced snaps



7051
Cape Sleeve



7052
Apron

Ironcat® Cotton Sateen Cape Sleeve & Bib 7051 | 7052

- 9 oz. cotton sateen fabric
- Adjustable cotton strap and 6 snap adjustments along the width of the bib



Welding Aprons

STYLE	FABRIC	GRADE	WEIGHT	POCKETS	COLOR	SIZES
7010	Split Cowhide Leather	Premium	-	2 chest pockets	Brown	36" & 42"
7011	Split Cowhide Leather	Premium	-	2 chest pockets	Brown	36" & 42"
7012	Split Cowhide Leather	Premium	-	-	Brown	24"
7080	FR Treated Sateen Cotton	Premium	9 oz.	-	Green	36" & 42"
7043	FR Treated Cotton Twill	Standard	9 oz.	-	Green	36"

Cape Sleeves

STYLE	FABRIC	GRADE	WEIGHT	POCKETS	COLOR	SIZES
7000	Split Cowhide Leather	Premium	-	-	Brown	M-4XL
7051	FR Treated Sateen Cotton	Premium	9 oz.	-	Green	M-3XL

Welding Bibs

STYLE	FABRIC	GRADE	WEIGHT	POCKETS	COLOR	SIZES
7001	Split Cowhide Leather	Premium	-	-	Brown	14" & 20"
7052	FR Treated Cotton Sateen	Premium	9 oz.	-	Green	14" & 20"



Scan it

FR Apparel

COMFORTABLE AND
BREATHABLE



ARC Rated Flame Resistant Apparel



305-2200
Solid vest



385-1370FR
AR/FR Fleece Hoodie



385-FRWS
AR/FR Workshirt



385-FRLS
Long Sleeve T-Shirt

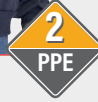

385-FRPH
AR/FR Fleece Hoodie

Flame Resistant Apparel

STYLE	COLORS AVAILABLE	ANSI 107	PPE CATEGORY	ARC RATING	MATERIAL	WEIGHT	POCKETS	STANDARD	CLOSURE	REFLECTIVE	SIZE
305-2200	Hi-Vis Yellow	2	2	8.9 cal/cm ²	Westex	6.2 oz. Solid	0	ANSI 107, NFPA 70E, ASTM F1506	Hook and Loop	2" Silver	M - 5XL
305-3200	Hi-Vis Yellow	3	2	8.9 cal/cm ²	Westex	6.5 oz. Solid	0	ANSI 107, NFPA 70E, ASTM F1506	Hook and Loop	2" Silver	M - 5XL
385-FRLS	Navy, Orange, Light Gray, Gray	-	2	11.8 cal/cm ²	100% Cotton	6.5 oz.	1	NFPA 70E, ASTM F1506	Pullover	-	M - 4XL
385-FRPH	Navy & Orange	-	2	20.9 cal/cm ²	Cotton	12 oz. Fleece	0	NFPA 70E, ASTM F1506	Pullover	-	M - 3XL
385-1370FR	Hi-Vis Yellow / Black	3	2	19.2 cal/cm ²	Fleece	11.2 oz. Fleece	2	ANSI 107, NFPA 70E, ASTM F1506	Zipper	2" Silver FR	S - 5XL
385-FRWS	Khaki / Navy	-	2	8.5 cal/cm ²	Cotton/FR Twill	7 oz.	2	NFPA 70E, NFPA 2112-2012	FR Buttons	-	S - 4XL



Dual Certified Clothing



Dual certified means the garment and material have been tested and certified by a third party and indicates compliance with two standards:

NFPA 70e:

Standard for electrical safety in the workplace

NFPA 2112:

Standard for protection against flash fire

385-FRSC
Coverall



385-FRWS
Workshirt

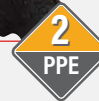

Dual Certified Clothing

STYLE NUMBER	COLOR	GARMENT	PPE CATEGORY	ARC RATING	MATERIAL	POCKETS	STANDARD	CLOSURE	SIZE
385-FRSC-KH 385-FRSC-NV	Khaki Navy	Flame Resistant Coverall	2	8 cal/cm ²	Cotton/Nylon	8	NFPA 70E, ASTM F1506 & NFPA 2112-2012	Zipper	S - 5XL
385-FRWS-KH 385-FRWS-NV	Tan Navy	Flame Resistant Shirt	2	8.5 cal/cm ²	Cotton/Nylon	2	NFPA 70E, ASTM F1506 & NFPA 2112-2012	Buttons	M - 4XL

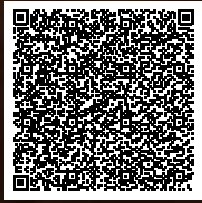

Scan it

Above-the-neck Protection

ULTIMATE COMFORT
AND PERFORMANCE



FACE SHIELDS

bouton



BOUTON® OPTICAL VISOR
250-01-5201
- Universal hole pattern will fit most headgear and hard hat adapters



BOUTON® OPTICAL VISOR
250-01-7204
- Made with virgin resin which leads to better uniformity of the viewing area



BOUTON® OPTICAL VISOR
250-01-7311
- Cylindrical shape is tapered at the chin for improved head/neck range of motion

HEADGEAR



BOUTON® OPTICAL BRACKET
251-01-5271
- Lightweight aluminum provides a secure face shield mounting for tough jobs



BOUTON® OPTICAL HEADGEAR
251-01-5400
- Lightweight and durable construction with universal visor attachments

Face Shields

STYLE	MATERIAL	LENS	THICKNESS	SIZE	BINDING	SHAPE	STANDARDS
251-01-5201	Polycarbonate	Clear	0.040"	8" x 15.5"	-	Flat	ANSI Z87+
251-01-7206	Polycarbonate	Clear	0.060"	8" x 15.5"	-	Flat	ANSI Z87+
251-01-7204	Polycarbonate	Clear	0.040"	9" x 15.5"	Aluminum	Curved	ANSI Z87+
251-01-7311	Polycarbonate	Medium Green	0.078"	8" x 15"	-	Molded-Cylindrical	ANSI Z87+
251-01-7312	Polycarbonate	Dark Green	0.078"	8" x 15"	-	Molded-Cylindrical	ANSI Z87+
251-01-7313	Polycarbonate	IR Filter 3.0	0.078"	8" x 15"	-	Molded-Cylindrical	ANSI Z87+
251-01-7315	Polycarbonate	IR Filter 5.0	0.078"	8" x 15"	-	Molded-Cylindrical	ANSI Z87+

Headgear

STYLE	MATERIAL	FIT	HOLE PATTERN
251-01-5400	Polypropylene	Premium Fine Tooth Ratchet	Universal
251-01-5271	Aluminum	Cap Style Hard Hat	Universal



Bouton® Safety Glasses

bouton



ANSER™
250-AN-10119
IR lenses help protect eyes from UV rays and flash burns, while also offering a high level of impact protection



ZENON Z13™
250-06-0014
Soft rubber tips on the temples provide comfort behind the ear, as well as a secure fit



FORTIFY™
250-54-0024
Lightweight and comfortable foam-sealed design keeps out dust and airborne particles



OVERSITE™
250-98-0013
Adjustable Over-The-Glass (OTG) style offers a perfect fit over any kind of personal eyewear

Welding Eyewear

STANDARDS MET

STYLE NUMBER	LENS	COATING	FRAME	ANSI Z87.1+	CSA Z94.3	BASE CURVE	FIT	BRIDGE	TEMPLE	PROP 65
250-AN-10520	☐ Clear	FogLess 3Sixty™	■ Black	•	•	9	Universal	Rubber	Bayonet, Rubber Tips	⚠ ^R
250-AN-10118	■ IR Filter 3.0	Anti-Scratch	■ Black	•	•	9	Universal	Rubber	Bayonet, Rubber Tips	⚠ ^R
250-AN-10119	■ IR Filter 5.0	Anti-Scratch	■ Black	•	•	9	Universal	Rubber	Bayonet, Rubber Tips	⚠ ^R
250-06-0014	■ IR Filter 1.7	Anti-Scratch	■ Black	•	•	10	Universal	Molded	Flexible, Rubber Tips	⚠ ^R
250-54-0024	■ IR Filter 1.7	Anti-Fog	■ Gray	•	•	9	Universal	Molded	Flexible, Co-Molded	⚠ ^R
250-98-0024	■ IR Filter 1.7	Anti-Scratch / Anti-Fog	■ Black/Gray	•	•	3	Universal	Molded	Rubber Spatula, Co-Molded	⚠ ^R
250-98-0013	■ IR Filter 3.0	Anti-Scratch	■ Black/Gray	•	•	3	Universal	Molded	Rubber Spatula, Co-Molded	⚠ ^R
249-5907-207	■ IR Filter 3.0	Anti-Scratch	■ Smoke	•	•	6	Universal	Molded	Spatula	⚠ ^R

C = ⚠ **WARNING:** Cancer - www.P65Warnings.ca.gov

R = ⚠ **WARNING:** Reproductive Harm - www.P65Warnings.ca.gov

C&R = ⚠ **WARNING:** Cancer and Reproductive Harm - www.P65Warnings.ca.gov

IR Filter Shade

IR lenses help protect eyes from UV rays and infrared flash burns, while cutting, brazing and torch soldering. These products also offer ANSI Z87.1+ level of impact protection.

IR 1.7

54% VISIBLE LIGHT TRANSMISSION



IR 3.0

10% VISIBLE LIGHT TRANSMISSION



IR 5.0

2% VISIBLE LIGHT TRANSMISSION





Hearing Protection



263-NP120

24
NRR

EAR MUFF

Mirage™ Neck Band

- Non-slip customizable strap adjustment
- Lightweight, low profile ear cups
- Protection for moderate noise exposure

STYLE	NRR	TYPE	DIELECTRIC	SIZE ADJUSTMENT	COLOR
263-NP120	24	Neck Band	No	Adjustable Strap with Velcro	Black/Yellow



267-HPF810

33
NRR



267-HPF810C

Mega Bullet™ Plus

- Regular size fits most ear canals
- Easy roll-down for quick and easy insertion
- PowerSoft™ Foam Technology features a proprietary polyurethane formulation that delivers optimal recovery time, easy insertion and maximum all-day comfort
- Shape conforms to most ear canals for maximum sound attenuation



267-HPF910

33
NRR



267-HPF910C

Mega Flare™ Plus

- Design resists backing out of ear
- Non-irritating smooth outer surface
- PowerSoft™ Foam Technology features a proprietary polyurethane formulation that delivers optimal recovery time, easy insertion and maximum all-day comfort
- Shape conforms to most ear canals for maximum sound attenuation



267-HPR310

25
NRR

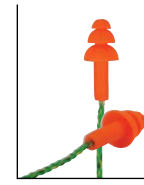

267-HPR310C

3-Flange Reusable

- Self-sealing 3-flange TPR (thermoplastic rubber) for all-day use and secure sound attenuation
- Corded version offers removable cord

STYLE NUMBER	NRR	USE	CORDING	MATERIAL	SIZE	SHAPE	COLOR	DETECTABLE	PAIR / PACK
Mega Bullet™ Plus									
267-HPF810	33	Single	Uncorded	PowerSoft™ Polyurethane Foam	Standard	Bullet	Orange	No	200 / Box
267-HPF810C	33	Single	Black PVC Cord	PowerSoft™ Polyurethane Foam	Standard	Bullet	Orange	No	100 / Box
Mega Flare™ Plus									
267-HPF910	33	Single	Uncorded	PowerSoft™ Polyurethane Foam	Standard	Contoured	Red	No	200 / Box
267-HPF910C	33	Single	Black PVC Cord	PowerSoft™ Polyurethane Foam	Standard	Contoured	Red	No	100 / Box
3-Flange Reusable									
267-HPR310	25	Reusable	Uncorded	TPR (thermoplastic rubber)	Standard	3-flange	Orange	No	200 / Box
267-HPR310C	25	Reusable	Textile Cord	TPR (thermoplastic rubber)	Standard	3-flange	Orange	No	100 / Box

Respiratory Protection



STANDARD N95



N95 Disposable Respirator

270-RPD713N95

- Curved nose clip follows the contours of the user's nose for a superior seal which helps minimize the fogging of eyewear

ECONOMY N95



N95 Economy Disposable Respirator

270-RPD513N95

- Open-cell foam nose pad creates a cushion between the nose and the mask for increased comfort

Respirators

STYLE	EXHALATION VALVE	NOSE PIECE	HEAD STRAP	STRAP ATTACHMENT	FLAME RESISTANT	APPROVALS
270-RPD713N95	No	Adjustable Aluminum	Latex-Free Woven	Ultrasonically Welded	No	NIOSH Certified
270-RPD513N95	No	Adjustable Aluminum	Latex-Free Woven	Ultrasonically Welded	No	NIOSH Certified



Dynamic® Head Protection



ELEVATED HEAT APPLICATIONS

Dynamic® Vesuvio™ 280-HP851

- Ambient heat protection up to 400°F
- Wheel ratchet size adjustment
- ANSI/CSA Type I; Class E

POPULAR COLORS



Dynamic® Stromboli™ 280-HP84

- ABS/Polycarbonate matte finished shell
- Wheel or swing ratchet adjustment
- ANSI/CSA Type I or 2; Class E

POPULAR COLORS



Head Protection

STANDARDS MET

STYLE NUMBER	CLASS	TYPE	ANSI Z89.1	CSA Z94.1-15	SHELL MATERIAL	SUSPENSION	SIZE ADJUSTMENT	BRIM	FEATURES	AVAILABLE COLORS
Dynamic® Vesuvio™										
280-HP851	Class E (NON-VENTED)	Type I	•	•	Nylon Resin	4-Point Nylon	Wheel Ratchet	Standard	Ambient heat protection up to 400°F	Gray, Dark Gray, Black, Steel Blue
Dynamic® Stromboli™										
280-HP84IR	Class E (NON-VENTED)	Type I	•	•	ABS/Polycarbonate	4-Point Nylon	Wheel Ratchet	Standard	High Strength Outer Shell with Matte Finish	White, Yellow, Orange, Gray, Red, Steel Blue
280-HP84ISR	Class E (NON-VENTED)	Type I	•	•	ABS/Polycarbonate	4-Point Nylon	Swing Wheel Ratchet	Standard	High Strength Outer Shell with Matte Finish	White, Yellow, Orange, Gray, Red, Steel Blue
280-HP84ZR	Class E (NON-VENTED)	Type II	•	•	ABS/Polycarbonate	4-Point Nylon	Wheel Ratchet	Standard	High Strength Outer Shell with Matte Finish	White, Yellow, Orange, Gray, Red, Steel Blue



Dynamic® Cap Lock Blades 251-EPHC

- To attach welding helmets, headgears or brackets to a hard hat

Full Face Protection



906-8416CBX CARBON/TECHNORA® FULL FACE HOOD

- Carbon fiber is lightweight and provides excellent fire resistance
- Technora® adds strength, durability and helps hood retain its shape when laundered
- TPP Rating 28 & Meets NFPA 1971 Requirements



202-101 SINGLE-LAYER NOMEX® BALACLAVA- FULL FACE

- Nomex® flame-resistant balaclavas offer limited chemical splash protection along with excellent wear and durability
- Protective qualities of Nomex® fabric will not wash out



FR Face Protection

STYLE	COVERAGE	LAYER	BIB	COLOR	SIZES
906-8416CBX	Full Face	Single	With	Black	OSFM
202-101	Full Face	Single	Without	Black	OSFM

Electrical SAFETY

ARC and Flame Resistance

ARC RATED (AR)

ARC Rated (AR) garments help to provide flame and thermal protection from exposure to an electrical ARC flash. AR garments are designed and treated to help limit exposure and burn percentage as a result of an electrical ARC flash incident.

There are many variables to consider when selecting AR protective clothing. Most importantly, the employer must perform a Hazard Risk Analysis for the workplace to identify risks and set the appropriate boundaries. The results of this analysis will then guide the employer to the level of protection needed.

The National Fire Protection Association (NFPA) uses four ARC flash PPE Categories to classify ranges of ARC flash hazards, and the corresponding requirements for Personal Protective Equipment (PPE). The categories are one method used in the current NFPA 70E standard to inform workers about the protection they need while working on energized equipment.

Each category includes a minimum ARC Rating (AR) value for the required garment. This value indicates the amount of heat energy (in cal/cm²) that the clothing can absorb or block before the wearer would be likely to receive a second-degree burn. (Second-degree burns are expected when skin is exposed to 1.2 cal/cm² of incident energy.)

PPE Category 1 and 2 requirements are typically met with single-layer ARC/FR garments and lighter head and face gear. To meet higher risk hazard levels such as PPE Category 3 or 4, multi-layer garments and headgear with more coverage is required.

IMPORTANT: All AR garments are flame-resistant, however not all FR garments are rated for ARC flash protection.

FLAME RESISTANT (FR)

Flame resistant garments earn their designation because they are made of fabrics that are inherently resistant to or are treated to be resistant to igniting when exposed directly to flame. The material resists ignition and/or will self-extinguish when ignited and will not melt. FR garments also create a thermal barrier to help protect the wearer's skin when exposed to direct heat energy and may minimize the amount of second- and third-degree burns incurred.

FR fabrics include:

- > Modacrylics, Aramids and Para-aramids are among the inherently flame-resistant fabrics. They do not lose those characteristics through wear or laundering.
- > Treated Fabrics such as cotton and cotton blends require FR treatment to achieve self-extinguishing properties. This treatment will eventually fade with washing. However, if the garment is properly cared for, the treatment can last the life of the garment. FR treated cotton and cotton blends provide a more comfortable and affordable solution.

DUAL CERTIFIED PROTECTION

Dual Certified means that the materials have been tested and certified to meet both the NFPA 70E (ARC Flash Protection) and the NFPA 2112 (Flash Fire Protection) standards. The NFPA 2112-2012 requires third-party certification of the garment. All PIP® NFPA 2112-2012 certified garments are UL certified. All PIP® Dual-Certified apparel are identified as such.

The NFPA 70E should be reviewed thoroughly and regularly to ensure compliance and to be aware of any revisions or updates as they occur.

Understanding Rubber Insulating Gloves

AS ONE OF THE MOST IMPORTANT COMPONENTS OF PPE FOR ELECTRICAL WORKERS, RUBBER INSULATING GLOVES NEED TO BE STRONG, FLEXIBLE, DURABLE AND, OF COURSE, DIELECTRIC.

RUBBER INSULATING GLOVES STANDARDS AND USE

Rubber insulating gloves are critical PPE for electrical workers. Electrical insulating gloves help protect electricians and utility workers from electrical shock if contact is made to an energized surface. Gloves should meet and/or exceed the requirements of the ASTM D120-14a – Standard Specification for Rubber Insulating Gloves. Gloves should also be electrically tested following ASTM D120-14a.

The proper function of rubber insulating gloves is extremely critical and there are strict requirements outlined by OSHA 29 CFR 1910.137 with regards to their use and in-service care. There are also different classes of gloves available depending on the level of voltage protection they provide (see the table in the Rubber Insulating Glove section for chart).

LEATHER PROTECTORS

Rubber insulating gloves work as a system with leather protectors that are worn over the rubber insulating gloves when working. Leather protectors help provide cut, puncture and abrasion protection for the rubber insulating gloves. The class of the leather protectors needs to match the class of the electrical gloves. Leather protectors alone do not provide electrical protection.

LINER GLOVES

Reduce the discomfort of wearing rubber insulating gloves. Liners provide warmth in cold weather and absorb perspiration in the warm months.

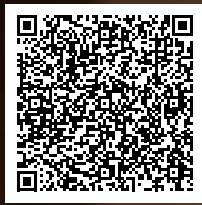

Scan it

New Installations

Installing Electrical Equipment / Pulling Wire & Cable / Installing Cable / Tray & Conduit / Connecting Wires



Seamless Knit Coated Gloves



34-874

- High dexterity and tactility
- Excellent dry grip and compatibility with light oils



ANSI **A2**

16-D622

- General use glove with light cut resistance
- Comfortable wearing glove for multi-task operations



ANSI **A4**

16-560

- Liner/coating hides dirt for longer wear
- Flexible liner with thin coating for precision work



ANSI **A2**

34-8743

- High dexterity and tactility
- Patented MicroFoam nitrile coating offers 360° breathability



ANSI **A3**

44-3445

- High tactile sensitivity and dexterity
- Patented MicroFoam nitrile coating offers 360° breathability



ANSI **A3**

44-3455

- High tactile sensitivity and dexterity
- Patented MicroFoam nitrile coating offers 360° breathability

FULL COATING COVERAGE

Heavy Duty Gloves



ANSI **A2**



09-K3750

- ARC rated with high cut protection
- Provides high abrasion resistance
- Straight thumb is ergonomic providing better dexterity



ANSI **A4**



KS992K

- High cut and puncture resistance
- Protects against ARC flash
- High comfort and protection



ANSI **A4**



KS993KOAB

- High cut and puncture resistance
- Protects against ARC flash
- Water and oil resistant

Seamless Knit Coated Gloves

STYLE NUMBER	ANSI CUT	EN388	COATING	COATING COVERAGE	COATING COLOR	LINER	LINER COLOR	GAUGE	SIZES	PROP 65
16-D622	A2	4342BX	Polyurethane	Palm & Fingers	Gray	PolyKor	White	13	XS - 2XL	⚠️ C
16-560	A4	4543DX	Polyurethane	Palm & Fingers	Gray	PolyKor	Gray	13	XS - 2XL	⚠️ C
34-874	-	4131AX	Nitrile MicroFoam	Palm & Fingers	Black	Nylon / Lycra	Gray	15	XXS-3XL	-
34-8743	A2	4331BX	Nitrile MicroFoam	Palm & Fingers	Black	MaxiFlex® Cut™	Green	15	XS - 3XL	-
44-3445	A3	4542CX	Nitrile MicroFoam	Palm & Fingers	Black	MaxiCut® Ultra DT™	Blue	15	XS - 2XL	-
44-3455	A3	4542CX	Nitrile MicroFoam	Palm & Fingers	Black	MaxiCut® Ultra DT™	Blue	15	XS - 2XL	-

Heavy-Duty Gloves

STYLE NUMBER	ANSI CUT	EN388	ANSI/ISEA 138	MATERIAL	BACK	CLIFF	COLOR	SIZES	PROP 65
09-K3750	A2	3322BX	-	Top Grain Goatskin	-	Slip-on	Natural	S - 3XL	-
KS992K	A4	2432DX	-	Top Grain Cowhide	-	Slip-on	Natural	S - 3XL	-
KS993KOAB	A4	2524DX	Impact Level 2	Top Grain Goatskin	TPR	Slip-on	Brown	S - 3XL	-

C = ⚠️ WARNING: Cancer - www.P65Warnings.ca.gov

R = ⚠️ WARNING: Reproductive Harm - www.P65Warnings.ca.gov

CR = ⚠️ WARNING: Cancer and Reproductive Harm - www.P65Warnings.ca.gov



Head Protection



**DYNAMIC[®]
WHISTLER™
HARD HAT
280-HP241R**

Cap Style Hard Hat with HDPE Shell,
4-Point Textile Suspension and Wheel
Ratchet Adjustment



**DYNAMIC[®]
KILIMANJARO™
HARD HAT
280-HP641R**

Full Brim Hard Hat with HDPE Shell,
4-Point Textile Suspension and Wheel
Ratchet Adjustment

STANDARDS MET

STYLE NUMBER	CLASS	TYPE	ANSI Z89.1	CSA Z94.1-15	SHELL MATERIAL	SUSPENSION	SIZE ADJUSTMENT	BRIM	AVAILABLE COLORS	PROP 65
280-HP241R	Class E (NON-VENTED)	Type I	•	•	HDPE	4-Point Nylon	Wheel Ratchet	Standard	White, Yellow, Orange, Green, Blue, Gray, Black, Red	⚠️ R
280-HP641R	Class E (NON-VENTED)	Type I	•	•	HDPE	4-Point Nylon	Wheel Ratchet	Full Brim	White, Yellow, Orange, Dark Green, Sky Blue, Blue, Gray, Red, Dark Gray, Royal Blue, Hi-Vis Yellow, Hi-Vis Orange	⚠️ R

C = ⚠️ **WARNING:** Cancer - www.P65Warnings.ca.gov

R = ⚠️ **WARNING:** Reproductive Harm - www.P65Warnings.ca.gov

C&R = ⚠️ **WARNING:** Cancer and Reproductive Harm - www.P65Warnings.ca.gov

Eye Protection



MEETS ANSI
Z87.1+

**ANSER™
250-AN-11120**

Lightweight, semi-rimless design
provides all-day user comfort



MEETS ANSI
Z87.1+ MEETS CSA
Z94.3

**RECON™
250-32-0520**

Lightweight, rimless design for ergonomic fit



MEETS ANSI
Z87.1+

**DOUBLE MAG READERS™
250-25-2020**

Safety readers in a semi-rimless design



MEETS ANSI
Z87.1+

**ZENON Z13R™
250-26-0020**

Reader version of the popular Z13™ style

STANDARDS MET

STYLE NUMBER	LENS	COATING	FRAME	DIOPTR	ANSI Z87.1+	CSA Z94.3	BASE CURVE	FIT	BRIDGE	TEMPLE	PROP 65
250-AN-11120	Clear	Anti-Scratch, Anti-Fog	Black	-	•	•	9	Universal	Rubber	Bayonet, Rubber Tips	⚠️ R
250-32-0520	Clear	Anti-Scratch, FogLess 3Sixty™	Clear	-	•	•	9	Universal	Rubber	Bayonet, Rubber Tips	⚠️ C&R
250-25-2020	Clear	Anti-Scratch, Anti-Fog	Black	1.50	•	•	8	Universal	Rubber	Rubber Tips	⚠️ R
250-26-0020	Clear	Anti-Scratch	Clear	2.00	•	•	10	Universal	Molded	Rubber Tips	⚠️ C&R

C = ⚠️ **WARNING:** Cancer - www.P65Warnings.ca.gov

R = ⚠️ **WARNING:** Reproductive Harm - www.P65Warnings.ca.gov

C&R = ⚠️ **WARNING:** Cancer and Reproductive Harm - www.P65Warnings.ca.gov

Arm Protection



ANSI
A3

20-TG

- Unparalleled comfort and coolness while providing cut and abrasion resistance
- Excellent fit and dexterity



ANSI
A3

10-KSTOLP

- Excellent cut protection and heat resistance
- Leather protective patch for added protection



ANSI
A4

10-21KVACPMBK

- Excellent protection against heat, cuts, lacerations and abrasions
- Exceptional comfort and fit
- Smart-Fit™ technology



ANSI
A2

15-21PRIBPS

- Exceptional comfort
- Excellent abrasion and fatigue resistance
- Smart-Fit™ technology

STYLE NUMBER	ANSI CUT	MATERIAL	CONSTRUCTION	PLY	TOP CUFF	BOTTOM CUFF	COLOR	STANDARD LENGTH	PROP 65
10-21KVACPMBK	A4	ACP™ / Kevlar™ Blend	Smart-Fit™ Seamless Knit	Single	Serged	Straight	Green	18"	-
15-21PRIBPS	A2	Pritex™	Smart-Fit™ Seamless Knit	Single	Serged	Straight	Black	12"	-
20-TG	A3	Dyneema™ Diamond	Seamless Knit	2	Serged	Straight	Gray	14"	-
10-KSTOLP	A3	DuPont™ Kevlar™	Seamless Knit	2	Serged	Thumb Hole	Yellow	14"	-

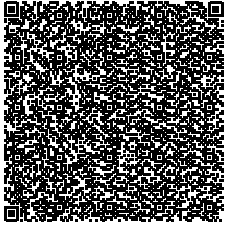

Scan it

Rubber Insulating Gloves



▲ 155-2-14
STRAIGHT CUFF



▲ 147-1-14
STRAIGHT CUFF



▲ 150-2-14
STRAIGHT CUFF



▲ 170-0-14
STRAIGHT CUFF



▲ 161-2-16
BELL CUFF



▲ 158-2-18
CONTOUR CUFF

NOVAX® Straight Cuff

STYLE NUMBER	CLASS	COLOR	LENGTH	SIZES
147-00-11	00	Orange	11"	7-12
150-00-11	00	Black	11"	7-12
150-00-14	00	Black	14"	7-12
170-00-11	00	Yellow	11"	7-12
170-00-14	00	Yellow	14"	7-12
147-0-11	0	Orange	11"	7-12
150-0-11	0	Black	11"	7-12
150-0-14	0	Black	14"	7-12
153-0-11	0	Red	11"	8-12
155-0-11	0	Black/Orange	11"	7-12
170-0-11	0	Yellow	11"	7-12
170-0-14	0	Yellow	14"	7-12
147-1-14	1	Orange	14"	7-12
150-1-14	1	Black	14"	7-12
153-1-14	1	Red	14"	7-12

STYLE NUMBER	CLASS	COLOR	LENGTH	SIZES
155-1-14	1	Black/Orange	14"	7-12
147-2-14	2	Orange	14"	7-12
150-2-14	2	Black	14"	7-12
152-2-16	2	Black/Yellow	16"	8-12
152-2-18	2	Black/Yellow	18"	8-12
153-2-14	2	Red	14"	7-12
155-2-14	2	Black/Orange	14"	7-12
155-2-16	2	Black/Orange	16"	8-12
155-2-18	2	Black/Orange	18"	8-12
170-2-14	2	Yellow	14"	7-12
155-3-16	3	Black/Orange	16"	8-12
155-3-18	3	Black/Orange	18"	9-12
155-4-16	4	Black/Orange	16"	9-12
155-4-18	4	Black/Orange	18"	9-12

NOVAX® Bell Cuff

STYLE NUMBER	CLASS	COLOR	LENGTH	SIZES
154-2-16	2	Black/Yellow	16"	8-12
154-2-18	2	Black/Yellow	18"	8-12
159-2-16	2	Black/Orange	16"	9-12
159-2-18	2	Black/Orange	18"	9-12
159-3-16	3	Black/Orange	16"	9-12
159-3-18	3	Black/Orange	18"	9-12
159-4-16	4	Black/Orange	16"	9-12
159-4-18	4	Black/Orange	18"	9-12
161-2-16	2	Black/Red	16"	8-12
161-2-18	2	Black/Red	18"	8-12
161-3-16	3	Black/Red	16"	9-11

NOVAX® Contour

STYLE NUMBER	CLASS	COLOR	LENGTH	SIZES
151-2-18	2	Black/Yellow	18"	8-12
158-2-18	2	Black/Orange	18"	8-12
162-2-18	2	Black/Red	18"	8-12
151-3-18	3	Black/Yellow	18"	9-12
158-3-18	3	Black/Orange	18"	8-12
151-4-18	4	Black/Yellow	18"	9-12
158-4-18	4	Black/Orange	18"	9-12
162-4-18	4	Black/Red	18"	9-11

STRONG, FLEXIBLE, DURABLE AND DIELECTRIC

Labeling

CLASS COLOR	NOVAX® GLOVE LABEL	TEST AC VOLTS	USE AC VOLTS	USE DC VOLTS
	10 NOVAX® by G.B. INDUSTRIES ANSI / ASTM MAX USE VOLT D120 CLASS 00 TYPE I MAX USE VOLT 3000V AC	2,500	500	750
	10 NOVAX® by G.B. INDUSTRIES ANSI / ASTM MAX USE VOLT D120 CLASS 0 TYPE I MAX USE VOLT 1000V AC	5,000	1,000	1,500
	10 NOVAX® by G.B. INDUSTRIES ANSI / ASTM MAX USE VOLT D120 CLASS 1 TYPE I MAX USE VOLT 7500V AC	10,000	7,500	11,250
	10 NOVAX® by G.B. INDUSTRIES ANSI / ASTM MAX USE VOLT D120 CLASS 2 TYPE I MAX USE VOLT 17000V AC	20,000	17,000	25,500
	10 NOVAX® by G.B. INDUSTRIES ANSI / ASTM MAX USE VOLT D120 CLASS 3 TYPE I MAX USE VOLT 26500V AC	30,000	25,500	39,750
	10 NOVAX® by G.B. INDUSTRIES ANSI / ASTM MAX USE VOLT D120 CLASS 4 TYPE I MAX USE VOLT 36000V AC	40,000	36,000	54,000

Standards and Regulations

OSHA

29CFR part 1910 (Occupational Safety and Health Standards)

ASTM

ASTM D120-14a (Rubber Insulating Gloves)

ASTM F496-14a (In-Service Care of Insulating Gloves and Sleeves)

ASTM F696-06 (Leather Protectors for Rubber Insulating Gloves and Mittens)

ASTM F1236-16 (Visual Inspection of Electrical Protective Rubber Products)

ASTM D1051-14a (Rubber Insulating Sleeves)

ASTM D1048-14 (Rubber Insulating Blankets)

NFPA

National Electric Safety Code

NFPA 70E (Electrical Safety in the Workplace - General Workplaces)



Rubber Insulating Products



Rubber Insulating Sleeves

STYLE NUMBER	CLASS	COLOR	SIZES
199-2	2	Yellow/Red	S-XL
199-3	3	Yellow/Red	S-XL



Rubber Insulating Blankets
(ASTM 1048-14, ISO 9001:2015)

STYLE NUMBER	CLASS	MATERIAL	STYLE	COLOR	SIZES
187-4	4	Type II Ozone-resistant rubber	Solid	Orange	36" x 36"
188-4	4	Type II Ozone-resistant rubber	Slotted	Orange	36" x 36"



Glove Inflator Kit

STYLE NUMBER	STANDARD
9010-51200	In compliance with OSHA 1910.137



Leather Protector Glove Covers

STYLE NUMBER	CLASS	MATERIAL	CUFF	LENGTH	SIZES
148-1000	00-0	Goatskin	Slip-on	10"	7-12
148-2000	00-0	Goatskin	Gauntlet	13"	7-12
148-4000	1-2	Goatskin	Gauntlet	12"	7-12
148-5000	1-2	Goatskin	Gauntlet	12"	8-12
148-6000	1-2	Goatskin	Gauntlet	14"	8-12
148-7000	3-4	Goatskin	Gauntlet	12"	9-12



Glove Storage Bags

STYLE NUMBER	COLOR	MATERIAL	LENGTH
148-2136	Black	Nylon	11"
148-2142	Black	Nylon	14"
148-6011	Natural	Canvas	11"
148-6014	Natural	Canvas	14"
148-6016	Natural	Canvas	16"
148-6018	Natural	Canvas	18"
148-6030	Natural	Canvas	30"
148-6330	Natural	Canvas	30"

Electrical Safety Kits

Just pick the class that your application requires, the color and size rubber glove that you want and we do the rest by assembling a kit that works.



CONTENTS:

- 1 PAIR OF RUBBER INSULATING GLOVES
- 1 PAIR OF LEATHER PROTECTOR GLOVE COVERS
- 1 11" OR 14" STORAGE BAGS FOR GLOVES

Electrical Safety Kits

STYLE NUMBER	CLASS	LENGTH	SIZES	ESP GLOVES	GLOVE PROTECTION	STORAGE
147-SK-00	00	11"	7-12	147-00-11	148-1000	148-2136
150-SK-00	00	11"	7-12	150-00-11	148-1000	148-2136
150-SK-00-14	00	14"	7-12	150-00-14	148-4000	148-2136
147-SK-0	0	11"	7-12	147-0-11	148-1000	148-2136
150-SK-0	0	11"	7-12	150-0-11	148-1000	148-2136
150-SK-0-14	0	14"	7-12	150-00-14	148-4000	148-2136
147-SK-1	1	14"	7-12	147-1-14	148-4000	148-2142
150-SK-1	1	14"	7-12	150-1-14	148-4000	148-2142
147-SK-2	2	14"	7-12	147-2-14	148-4000	148-2142
150-SK-2	2	14"	7-12	150-2-14	148-4000	148-2142
155-SK-2	2	14"	7-12	155-2-14	148-4000	148-2142

All kit gloves are black



NFPA 70E PPE Categories

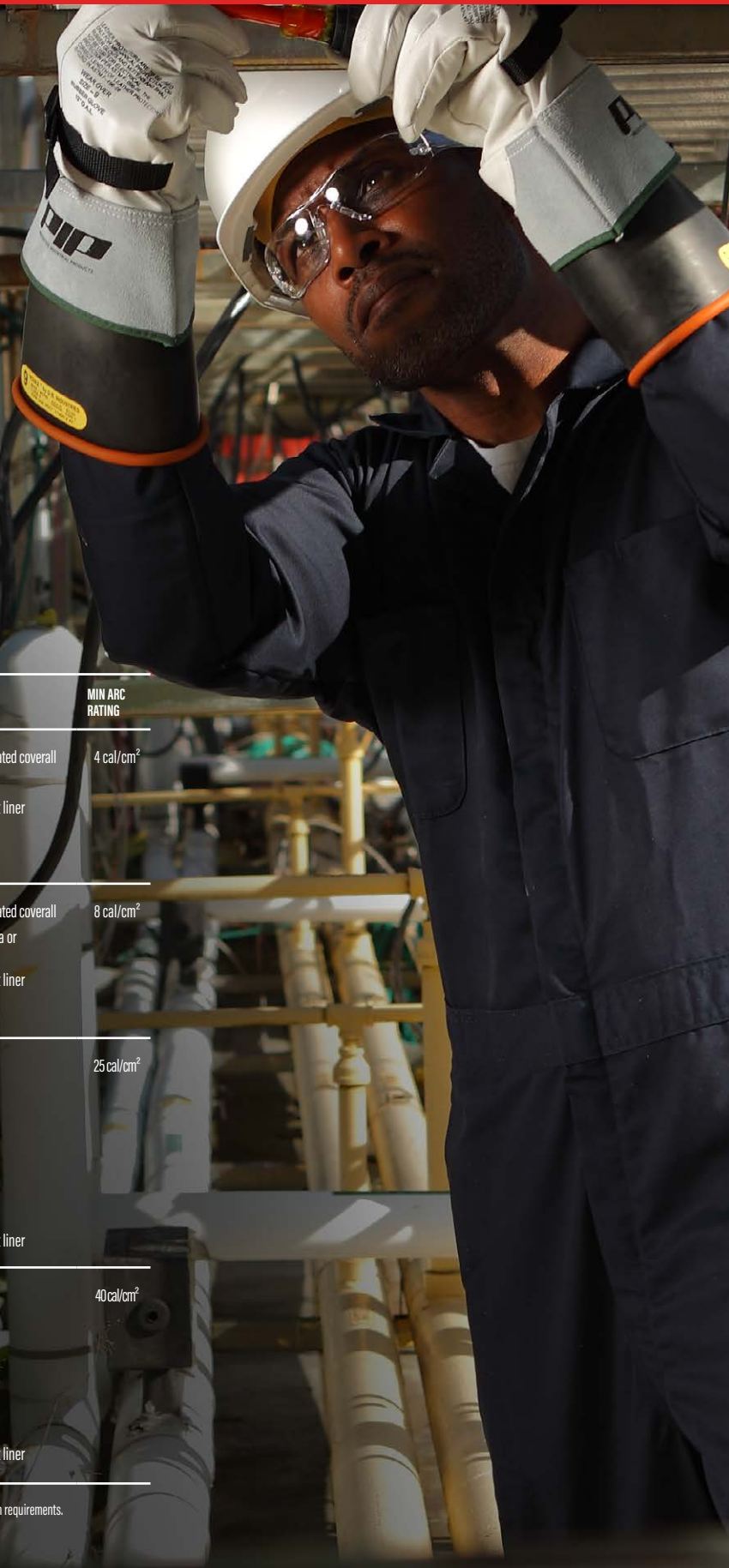

PPE CATEGORY	PROTECTIVE EQUIPMENT	PROTECTIVE CLOTHING	MIN ARC RATING
1 PPE	<ul style="list-style-type: none"> • Hard hat • Safety glasses or safety goggles (SR) • Hearing protection (ear canal inserts) • Heavy-duty leather gloves* • Leather work shoes 	<ul style="list-style-type: none"> • ARC rated long sleeve shirt and pants or ARC rated coverall • ARC rated face shield or ARC flash suit hood • ARC rated jacket, parka, rainwear or hard hat liner 	4 cal/cm ²
2 PPE	<ul style="list-style-type: none"> • Hard hat • Safety glasses or safety goggles (SR) • Hearing protection (ear canal inserts) • Heavy-duty leather gloves* • Leather work shoes 	<ul style="list-style-type: none"> • ARC rated long sleeve shirt and pants or ARC rated coverall • ARC rated face shield and ARC rated balaclava or ARC flash suit hood • ARC rated jacket, parka, rainwear or hard hat liner 	8 cal/cm ²
3 PPE	<ul style="list-style-type: none"> • Hard hat • Safety glasses or safety goggles (SR) • Hearing protection (ear canal inserts) • Heavy-duty leather gloves* • Leather work shoes 	<ul style="list-style-type: none"> • ARC rated long sleeve shirt • ARC rated pants • ARC rated coverall • ARC rated ARC flash suit jacket • ARC rated ARC flash suit pants • ARC rated ARC flash suit hood • ARC rated gloves • ARC rated jacket, parka, rainwear or hard hat liner 	25 cal/cm ²
4 PPE	<ul style="list-style-type: none"> • Hard hat • Safety glasses or safety goggles (SR) • Hearing protection (ear canal inserts) • Heavy-duty leather gloves* • Leather work shoes 	<ul style="list-style-type: none"> • ARC rated long sleeve shirt • ARC rated pants • ARC rated coverall • ARC rated ARC flash suit jacket • ARC rated ARC flash suit pants • ARC rated ARC flash suit hood • ARC rated gloves • ARC rated jacket, parka, rainwear or hard hat liner 	40 cal/cm ²

* NFPA 70E Table 130.7(C)(16) Note 1 - The combination of rubber insulating gloves and leather protectors satisfies the ARC flash protection requirements.



Scan it



ARC Protective Shields



PREMIUM ANTI-FOG COATING
Reduces fogging while maintaining clear vision

SLOT ATTACHMENT
Designed to fit slotted hard hats

CHIN PROTECTOR
Provides additional protection to the chin and neck areas



Adapters & storage bags



ARC Protective Shields (NFPA 70e, ASTM F2178, ANSI Z87+S, Includes Chin Cup)

STYLE NUMBER	ARC RATING	MATERIAL	FITS	CHIN CUP COLOR	INCLUDES
9400-55504	20 cal/cm ²	Polycarbonate	-	Gray	Replacement Shield
9400-55505	12 cal/cm ²	Polycarbonate	Cap Style	Gray	Clip Mount
9400-55511	20 cal/cm ²	Polycarbonate	Cap Style	Gray	Clip Mount
9400-55512	12 cal/cm ²	Polycarbonate	Full Brim	Transparent	Mounting Bracket
9400-55514	12 cal/cm ²	Polycarbonate	Cap Style	Transparent	Mounting Bracket
9400-55520	20 cal/cm ²	Polycarbonate	Full Brim	Transparent	Mounting Bracket
9400-55524	20 cal/cm ²	Polycarbonate	Cap Style	Transparent	Mounting Bracket

ARC Protective Accessories (NFPA 70E, ASTM F2178, ANSI Z87+S)

STYLE NUMBER	MATERIAL	DESCRIPTION
9400-52503	Nylon	Cap Style Hard Hat Adapter With Slotted Attachment
9400-52515	Polyurethane Backed Nylon	Large Backpack, Fits All ARC Kits, Orange, Made In USA
9400-52508	Cotton	Cotton Premium ARC Shield Storage Bag(Only), USA
9400-52509	Cotton	ARC Shield Storage Bag
9400-80016	Nylon	Universal Cap Bracket for Paulson ARC Shields with Elastomeric Attachment
9400-80017	Nylon	Slotted Cap Bracket for Paulson High Transparency Amp Shields
9400-80018	Nylon	Slotted and Non-Slotted Cap Bracket for Paulson High Transparency Amp Shields



Scan it



Head Gear Kits



PPE 2 ARC Head Gear Kits

COMPONENTS							ARC RATING
KIT NUMBER	BALACLAVA	ARC SHIELD	HEAD GEAR BAG	HARD HAT	SAFETY GLASSES	STORAGE BAG	
9150-52508	9100-HDFR15	9400-55505	9400-52509	Included	Included	-	12 cal/cm ²
9150-52512	9100-HDFR15	9400-55505	9400-52509	Included	Included	9400-52599	12 cal/cm ²
9150-52500	9100-HDFR15	9400-55505	9400-52509	Included	Included	9400-52515	12 cal/cm ²
9150-56510	-	9400-55505	-	Included	-	-	12 cal/cm ²
9150-56511	-	9400-55512	-	Included	-	-	12 cal/cm ²

** Component parts listed can be purchased separately for replacement*





Scan it



ARC Rated Shirts



385-FRLS



385-FRHN



385-FRSS



385-FRPH



385-FRZH



Next-to-skin
comfort and
breathability

ARC Rated Flame Resistant Shirts (short sleeve t-shirts should be worn as an undergarment only)

STYLE NUMBER	COLOR	GARMENT	PPE CATEGORY	ARC RATING	MATERIAL	WEIGHT	POCKETS	STANDARD	CLOSURE	SIZE
385-FRLS-NV	Navy	Long Sleeve T-Shirt	2	11.8 cal/cm ²	100% Cotton	6.5oz	1	NFPA 70E, ASTM F1506	Pullover	M - 4XL
385-FRLS-OR	Orange	Long Sleeve T-Shirt	2	11.8 cal/cm ²	100% Cotton	6.5oz	1	NFPA 70E, ASTM F1506	Pullover	M - 4XL
385-FRLS-LG	Light Gray	Long Sleeve T-Shirt	2	11.8 cal/cm ²	100% Cotton	6.5oz	1	NFPA 70E, ASTM F1506	Pullover	M - 4XL
385-FRLS-GR	Gray	Long Sleeve T-Shirt	2	11.8 cal/cm ²	100% Cotton	6.5oz	1	NFPA 70E, ASTM F1506	Pullover	M - 4XL
385-FRHN-NV	Navy	Long Sleeve Henley	2	11.8 cal/cm ²	100% Cotton	6.5oz	1	NFPA 70E, ASTM F1506	Pullover	M - 3X
385-FRHN-OR	Orange	Long Sleeve Henley	2	11.8 cal/cm ²	100% Cotton	6.5oz	1	NFPA 70E, ASTM F1506	Pullover	M - 3X
385-FRHN-LG	Light Gray	Long Sleeve Henley	2	11.8 cal/cm ²	100% Cotton	6.5oz	1	NFPA 70E, ASTM F1506	Pullover	M - 3X
385-FRSS-NV	Navy	Short Sleeve Shirt	2	11.8 cal/cm ²	100% Cotton	6.5oz	1	NFPA 70E, ASTM F1506	Pullover	M - 3X
385-FRSS-LG	Light Gray	Short Sleeve Shirt	2	11.8 cal/cm ²	100% Cotton	6.5oz	1	NFPA 70E, ASTM F1506	Pullover	M - 3X
ARC Rated Flame Resistant Sweatshirts										
385-FRPH-NV	Navy	Hoodie	2	20 cal/cm ²	100% Cotton	12 oz. Fleece Knit	1	NFPA 70E, ASTM F1506	Pullover	M - 3XL
385-FRPH-OR	Orange	Hoodie	2	20 cal/cm ²	100% Cotton	12 oz. Fleece Knit	1	NFPA 70E, ASTM F1506	Pullover	M - 3XL
385-FRZH-NV	Navy	Hoodie	2	20 cal/cm ²	100% Cotton	12 oz. Fleece Knit	2	NFPA 70E, ASTM F1506	Zipper	M - 3XL
385-FRZH-OR	Orange	Hoodie	2	20 cal/cm ²	100% Cotton	12 oz. Fleece Knit	2	NFPA 70E, ASTM F1506	Zipper	M - 3XL



Scan it



ARC Rated Clothing



9100-2170D
Coveralls



9100-52564
Overalls



9100-21782
Jacket



9100-22070
Overpants



ARC Rated Flame Resistant Dual Certified Coveralls (NFPA 70E, ASTM F1506)

STYLE NUMBER	COLOR	PPE CATEGORY	ARC RATING	MATERIAL	POCKETS	STANDARD	CLOSURE	SIZE
385-FRSC-NV	Navy	2	8 cal/cm ²	90% Cotton, 10% Nylon	8	NFPA 70E, ASTM F1506 & NFPA 2112-2012	Zipper	S - 5XL
385-FRSC-KH	Khaki	2	8 cal/cm ²	90% Cotton, 10% Nylon	8	NFPA 70E, ASTM F1506 & NFPA 2112-2012	Zipper	S - 5XL
9100-2100D	Tan	2	8 cal/cm ²	90% Cotton, 10% Nylon	2	NFPA 70E, ASTM F1506 & NFPA 2112-2012	Hook and Loop	S - 5XL
9100-2110D	Tan	2	8 cal/cm ²	90% Cotton, 10% Nylon	2	NFPA 70E, ASTM F1506 & NFPA 2112-2012	Hook and Loop	S - 5XL
9100-2120D	Blue	2	8 cal/cm ²	90% Cotton, 10% Nylon	2	NFPA 70E, ASTM F1506 & NFPA 2112-2012	Hook and Loop	S - 5XL
9100-2160D	Navy	2	8 cal/cm ²	90% Cotton, 10% Nylon	2	NFPA 70E, ASTM F1506 & NFPA 2112-2012	Hook and Loop	S - 5XL
9100-2170D	Navy	2	12 cal/cm ²	90% Cotton, 10% Nylon	2	NFPA 70E, ASTM F1506 & NFPA 2112-2012	Hook and Loop	S - 5XL

ARC Rated Flame Resistant Overalls (NFPA 70E, ASTM F1506)

9100-52564	Navy	2	12.4 cal/cm ²	90% Cotton, 10% Nylon	2	NFPA 70E, ASTM F1506	Buckle	S - 4XL
------------	------	---	--------------------------	-----------------------	---	----------------------	--------	---------

ARC Rated Flame Resistant Jackets (NFPA 70E, ASTM F1506)

9100-21782	Navy	2	12.4 cal/cm ²	90% Cotton, 10% Nylon	2	NFPA 70E, ASTM F1506	Hook and Loop	L - 2XL
------------	------	---	--------------------------	-----------------------	---	----------------------	---------------	---------

ARC Rated Flame Resistant Overpants (NFPA 70E, ASTM F1506)

9100-22070	Navy	2	12.4 cal/cm ²	90% Cotton, 10% Nylon	2	NFPA 70E, ASTM F1506	Hook and Loop	L - 2XL
------------	------	---	--------------------------	-----------------------	---	----------------------	---------------	---------



Scan it



ARC Protection Kits



PPE 2 ARC Protection Kits - Carry Bag (9400-52599)

COMPONENTS									FEATURE	ARC RATING	PPE RATING	SIZE
KIT NUMBER	COVERALL	JACKET	OVERALL	PANT	BALACLAVA	ARC SHIELD	HARD HAT	SAFETY GLASSES				
9150-5388E	9100-21600	-	-	-	9100-HDFR15	9400-55505	Included	Included	Action Back	8 cal/cm ²	2	S - 5XL
9150-5488E	9100-21700	-	-	-	9100-HDFR15	9400-55505	Included	Included	Action Back	12 cal/cm ²	2	S - 5XL
9150-52810	-	9100-21780	-	9100-22070	9100-HDFR15	9400-55505	Included	Included	2-Piece Set	12 cal/cm ²	2	S - 4XL
9150-52812	-	9100-21782	9100-52564	-	9100-HDFR15	9400-55505	Included	Included	2-Piece Set	12 cal/cm ²	2	S - 4XL
9150-52804	-	9100-21780	9100-52564	-	9100-HDFR15	9400-55505	Included	Included	2-Piece Set	12 cal/cm ²	2	S - 4XL
PPE 2 ARC Protection Kits - Back Pack (9400-52515)												
9150-53871	-	9100-21780	9100-52564	-	9100-HDFR15	9400-55505	Included	Included	2-Piece Set	12 cal/cm ²	2	S - 4XL
9150-5388EB	9100-21600	-	-	-	9100-HDFR15	9400-55505	Included	Included	Action Back	8 cal/cm ²	2	S - 5XL
9150-5488EB	9100-21700	-	-	-	9100-HDFR15	9400-55505	Included	Included	Action Back	12 cal/cm ²	2	S - 5XL

* Component parts listed can be purchased separately for replacement





Scan it



Dual Certified Clothing



Dual certified means the garment and material have been tested and certified by a third-party and indicates compliance with two standards:

NFPA 70e:

Standard for electrical safety in the workplace

NFPA 2112:

Standard for protection against flash fire



385-FRWS
Shirt

385-FRCJ
Carpenter jeans



385-FRWS
Shirt

385-FRRJ
Regular jeans

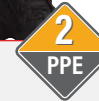

Dual Certified Clothing

STYLE NUMBER	COLOR	GARMENT	PPE CATEGORY	ARC RATING	MATERIAL	WEIGHT	POCKETS	STANDARD	CLOSURE	SIZE
385-FRWS-KH	Tan	Flame Resistant Shirt	2	8.5 cal/cm ²	Cotton/Nylon	7oz	2	NFPA 70E, ASTM F1506 & NFPA 2112-2012	Buttons	M - 4XL
385-FRWS-NV	Navy	Flame Resistant Shirt	2	8.5 cal/cm ²	Cotton/Nylon	7oz	2	NFPA 70E, ASTM F1506 & NFPA 2112-2012	Buttons	M - 4XL
385-FRRJ	Denim	Flame Resistant Jeans	2	16 cal/cm ²	Cotton/Twill/Denim	13oz	5	NFPA 70E, ASTM F1506 & NFPA 2112-2012	Zipper	30-50W x 30-36L
385-FRCJ	Denim	Flame Resistant Jeans	2	16 cal/cm ²	Cotton/Twill/Denim	13oz	6	NFPA 70E, ASTM F1506 & NFPA 2112-2012	Zipper	30-50W x 30-36L



Scan it

ARC Rated Flame Resistant Hi-Vis Apparel



Resists ignition
and self
extinguishes

Hi-Vis Apparel

STYLE NUMBER	COLOR	ANSI 107	GARMENT	PPE CATEGORY	ARC RATING	MATERIAL	WEIGHT	POCKETS	STANDARD	CLOSURE	REFLECTIVE	SIZE
305-2100	Hi-Vis Yellow	Type R Class 2	Mesh Vest	1	5.1 cal/cm ²	Modacrylic	6.2 oz. Mesh	1	ANSI 107, NFPA 70E, ASTM F1506	Hook and Loop	2" Silver	M - 5XL
305-2200	Hi-Vis Yellow	Type R Class 2	Solid Vest	2	8.9 cal/cm ²	Westex	6.2 oz Solid	0	ANSI 107, NFPA 70E, ASTM F1506	Hook and Loop	2" Silver	M - 5XL
305-3100	Hi-Vis Yellow	Type R Class 3	Mesh Vest	1	5.1 cal/cm ²	Modacrylic	6.2 oz Mesh	1	ANSI 107, NFPA 70E, ASTM F1506	Hook and Loop	2" Silver	M - 5XL
305-3200	Hi-Vis Yellow	Type R Class 3	Solid Vest	2	8.9 cal/cm ²	Westex	6.5 oz Solid	0	ANSI 107, NFPA 70E, ASTM F1506	Hook and Loop	2" Silver	M - 5XL
385-1370FR	Hi-Vis Lime Yellow/Black	Type R Class 3	Hoodie	2	19 cal/cm ²	Modacrylic / FR Cotton	12 oz. Fleece Knit	3	ANSI 107 Type R Class 3, NFPA 70E, ASTM F1506	Zipper	2" FR Segmented Heat Applied	S - 5XL
315-1350FR	Hi-Vis Yellow	Type R Class 3	Long Sleeve T-Shirt	2	8.6 cal/cm ²	100% Cotton	--	0	NFPA 70E, ASTM F1506	Pullover	2" Silver FR Treated	M - 5XL

ARC Rated Flame Resistant Rainwear

STYLE NUMBER	COLOR	ANSI 107	GARMENT	PPE CATEGORY	ARC RATING	MATERIAL	THICKNESS	POCKETS	STANDARD	CLOSURE	REFLECTIVE	SIZE
355-2500AR	Hi-Vis Yellow	Type R Class 3	Jacket	2	16 cal/cm ²	Cotton / Polyester	12 oz.	2	NFPA 70E, ASTM F1891, ASTM F2733, ANSI 107-2015	Zipper		S - 5XL
355-2501AR	Hi-Vis Yellow	-	Bib Overalls	2	16 cal/cm ²	Cotton / Polyester	12 oz.	0	NFPA 70E, ASTM F1891, ANSI 107-2015	Hook and Loop		S - 5XL
355-2505AR	Hi-Vis Yellow	Type R Class 3	Raincoat	2	16 cal/cm ²	Cotton / Polyester	12 oz.	2	NFPA 70E, ASTM F1891, ASTM F2733, ANSI 107-2015	Zipper		S - 5XL

Vests to be worn over ARC rated FR clothing only



High-Risk ARC Protection



Working in high-risk and high-voltage environments demands serious protection. PIP® offers a full line of ARC flash protection PPE to keep workers safe in the most demanding environments.



Scan it



ARC Flash Hoods

LIFT FRONT HOOD
makes it easy to obtain fresh air when outside of the hazard zone

PREMIUM ANTI-FOG COATING
Reduces fogging while maintaining clear vision

ERGONOMIC HOOD DESIGN
Allows for full rotation and movement without compromising coverage



9150-53850

Replacement window

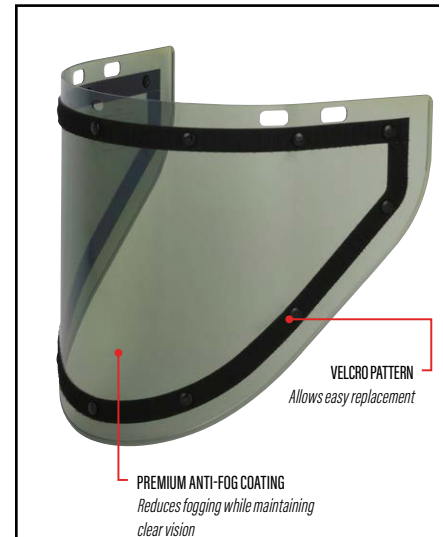

Electrical ARC Hoods - includes ARC shield, hard hat and mounting bracket (NFPA 70E, ASTM F1506)

STYLE NUMBER	WEIGHT	LAYERS	MATERIAL	PPE CAT	ARC RATING
9150-52548	9 oz.	1	Cotton / Nylon	2	12 cal/cm ²
9150-52515	7 oz.	2	Cotton / Nylon	3	25 cal/cm ²
9150-52685	9 oz.	2	Cotton / Nylon	3	33 cal/cm ²
9150-523ULT	8 oz. / 6 oz.	2	Protera [®] / Ultrasoft [®]	4	40 cal/cm ²
9150-52689	-	Multi	Ultrasoft [®] / High Tenacity Nylon	4	100 cal/cm ²
9150-52850	9 oz. / 13 oz.	2	Cotton / Nylon	4	40 cal/cm ²
9150-53850	8 oz. / 6.5 oz.	2	Protera [®] / Ultrasoft [®]	4	40 cal/cm ²
9150-5236V	8 oz. / 6 oz.	2	Protera [®] / Ultrasoft [®]	4	40 cal/cm ²
9150-5237V	8 oz. / 6 oz.	2	Protera [®] / Ultrasoft [®]	4	40 cal/cm ²

Electrical ARC Hood Replacement Windows (NFPA 70E, ASTM F2178, ANSI Z87+S)

9400-55517	6.4 oz.	-	Polycarbonate	3	25 cal/cm ²
9400-54686	8 oz.	-	Polycarbonate	4	40 cal/cm ²
9400-55569	9.6 oz.	-	Polycarbonate	4	100 cal/cm ²

9150-5236V
Ventilated hood with battery pack



9150-5237V
Ventilated dual-fan hood with rechargeable battery pack and heat sensor

Ventilating Units

- 6+ usable hours of battery life
- Ventilating unit and power pack are protected by a compact and durable ABS case covered by ultralight fabric

UNIT WEIGHT: 1 LB (16 OZ.)
AIRFLOW: 35 CFM



Scan it



ARC Rated Clothing



9100-52758
Coveralls



9100-52422
Overalls



9100-52680
Jacket



9100-530ULT
Overpants



ARC Rated Flame Resistant Coveralls

STYLE NUMBER	COLOR	PPE CATEGORY	ARC RATING	MATERIAL	POCKETS	STANDARD	CLOSURE	SIZE
9100-52758	Navy	Cotton / Nylon	3	33 cal/cm ²	3	NFPA 70E, ASTM F1506	Hook and Loop	S - 6XL
9100-52772	Navy	Cotton / Nylon	3	25 cal/cm ²	3	NFPA 70E, ASTM F1506	Hook and Loop	S - 6XL

ARC Rated Flame Resistant Overalls

9100-21731	Navy	Cotton / Nylon	3	25 cal/cm ²	2	NFPA 70E, ASTM F1506	Buckle	S - 6XL
9100-53680	Navy	Cotton / Nylon	3	33 cal/cm ²	2	NFPA 70E, ASTM F1506	Buckle	S - 6XL
9100-52422	Navy	Cotton / Nylon	4	40 cal/cm ²	2	NFPA 70E, ASTM F1506	Buckle	S - 5XL
9100-75001	Navy	Cotton / Nylon	4	75 cal/cm ²	2	NFPA 70E, ASTM F1506	Buckle	M - 5XL
9100-53750	Gray	Aramid / Cotton	4	100 cal/cm ²	2	NFPA 70E, ASTM F1506	Buckle	L - 3XL

ARC Rated Flame Resistant Jackets

9100-21721	Navy	Cotton / Nylon	3	25 cal/cm ²	2	NFPA 70E, ASTM F1506	Hook and Loop	S - 6XL
9100-52680	Navy	Cotton / Nylon	3	33 cal/cm ²	2	NFPA 70E, ASTM F1506	Hook and Loop	S - 6XL
9100-52412	Navy	Cotton / Nylon	4	40 cal/cm ²	2	NFPA 70E, ASTM F1506	Hook and Loop	S - 5XL
9100-524ULT	Navy	Protera / Ultrasoft	4	40 cal/cm ²	2	NFPA 70E, ASTM F1506	Hook and Loop	L - 2XL
9100-75000	Navy	Cotton / Nylon	4	75 cal/cm ²	2	NFPA 70E, ASTM F1506	Hook and Loop	M - 5XL
9100-52750	Gray	Aramid / Cotton	4	100 cal/cm ²	2	NFPA 70E, ASTM F1506	Hook and Loop	M - 5XL

ARC Rated Flame Resistant Overpants

9100-530ULT	Navy	Protera / Ultrasoft	4	40 cal/cm ²	4	NFPA 70E, ASTM F1506	Hook and Loop	L - 2XL
-------------	------	---------------------	---	------------------------	---	----------------------	---------------	---------



Scan it



ARC Protection Kits



PPE 3 & 4 ARC Protection Kits - Carry Bag (9400-52599)

COMPONENTS								FEATURE	ARC RATING	PPE RATING	SIZE
KIT NUMBER	COVERALL	JACKET	OVERALL	PANT	HOOD	HARD HAT	SAFETY GLASSES				
9150-52821	9100-52772	-	-	9150-52515	9150-52515	Included	Included	2-Piece Set	25 cal/cm ²	3	S - 6XL
9150-53003	-	9100-21721	9100-21731	9150-52515	9150-52515	Included	Included	Aramid Thread & Cuffs	25 cal/cm ²	3	S - 6XL
9150-52917	9100-52758	-	-	9150-52685	9150-52685	Included	Included	Aramid Thread & Cuffs	33 cal/cm ²	3	S - 6XL
9150-52609	-	9100-52680	9100-53680	9150-52685	9150-52685	Included	Included	2-Piece Set	33 cal/cm ²	3	S - 6XL
9150-52436	9100-52412	9100-52422	-	9150-52850	9150-52850	Included	Included	2-Piece Set	40 cal/cm ²	4	S - 6XL
9150-540ULT	9100-524ULT	-	9100-530ULT	9150-523ULT	9150-523ULT	Included	Included	Ultralight	40 cal/cm ²	4	S - 5XL
9150-54VULT	9100-524ULT	-	9100-530ULT	9150-5236V	9150-5236V	Included	Included	Ultralight	40 cal/cm ²	4	S - 5XL
9150-75050	9100-75000	9100-75001	-	9150-75002	9150-75002	Included	Included	2-Piece Set	75 cal/cm ²	4	M - 5XL
9150-52730	9100-52750	9100-53750	-	9150-52689	9150-52689	Included	Included	2-Piece Set	100 cal/cm ²	4	M - 5XL

PPE 3 ARC Protection Kits - Back Pack (9400-52515)

9150-52815	9100-52772	-	-	-	9150-52515	Included	Included	2-Piece Set	25 cal/cm ²	3	S - 6XL
9150-53018	-	9100-21721	9100-21731	-	9150-52515	Included	Included	Aramid Thread & Cuffs	25 cal/cm ²	3	S - 6XL
9150-52946	9100-52758	-	-	-	9150-52685	Included	Included	Aramid Thread & Cuffs	33 cal/cm ²	3	S - 6XL
9150-21712	-	9100-21780	9100-52564	-	9150-52685	Included	Included	2-Piece Set	33 cal/cm ²	3	S - 6XL
9150-540ULTB	9100-524ULT	-	9100-530ULT	-	9150-523ULT	Included	Included	Ultralight	40 cal/cm ²	4	S - 5XL
9150-54VULTB	9100-524ULT	-	9100-530ULT	-	9150-5236V	Included	Included	Ultralight	40 cal/cm ²	4	S - 5XL

* Component parts listed can be purchased separately for replacement



Scan it

Electrical ARC Rated Gloves



713KSSN
- Excellent dexterity, tactile sensitivity and cut resistance
- Good grip and excellent abrasion resistance
- Comfortable and breathable



73-K1800
- Excellent dexterity, tactile sensitivity and cut resistance
- Good grip and excellent abrasion resistance
- Comfortable and breathable



86560
- Flame and heat resistant
- Helps protect against ARC flash
- Excellent dexterity



09-K3750
- ARC rated with high cut protection
- Provides high abrasion resistance
- Straight thumb is ergonomic providing better dexterity



73-1700
- Outstanding comfort, fit and feel
- Enhanced cut protection and good heat dispersion
- Superior abrasion-resistant



KS993KOA
- High cut and puncture resistance
- Helps protect against ARC flash
- Water and oil resistant



KS993KOAB
- High cut and puncture resistance
- Helps protect against ARC flash
- Water and oil resistant



KS991KP
- Insulated with high cut and puncture resistance
- Helps protect against ARC flash
- Water and oil resistant



KS992K
- High cut and puncture resistance
- Helps protect against ARC flash
- High comfort and protection

STYLE NUMBER	ANSI CUT	PPE CAT	ARC RATING	EN388	COATING	LINER MATERIAL	GAUGE	COLOR	SIZES
713KSSN	A6	1	4.4 cal/cm ²	4542F	Nitrile Foam	Aramid / Stainless Steel	13	Green / Black	XS - 3XL
73-K1800	A4	1	7.4 cal/cm ²	2542C	Nitrile	Aramid	13	Yellow / Black	S - 2XL
86560	A3	3	24 cal/cm ²	-	-	Aramid	-	Black / White/ Orange	S - 2XL
09-K3750	A2	3	28.5 cal/cm ²	3322B	-	Kevlar [®]	-	Natural	S - 3XL
73-1700	A2	3	30 cal/cm ²	2332B	-	Kevlar [®]	-	Black / Brown	S - 2XL
KS993KOA	A4	4	43 cal/cm ²	2524D	-	Aramid	-	Brown	S - 3XL
KS993KOAB	A4	4	43 cal/cm ²	2524D	-	Aramid	-	Brown	S - 3XL
KS991KP	A4	4	43 cal/cm ²	2524D	-	Aramid / Fleece	-	Brown	S - 3XL
KS992K	A4	4	43 cal/cm ²	2432D	-	Kevlar [®]	-	Natural	S - 3XL



Head Protection

Scan it



DYNAMIC[®] KILIMANJARO[™] HARD HAT 280-HP641R

Full Brim Hard Hat with HDPE Shell, 4-Point Textile Suspension and Wheel Ratchet Adjustment



MK8 EVOLUTION[®] HARD HAT 280-AHS240

Type II Linesman Hard Hat with HDPE Shell, EPS Impact Liner, Polyester Suspension, Wheel Ratchet Adjustment and 4-Point Chin Strap

STANDARDS MET

STYLE NUMBER	CLASS	TYPE	ANSI Z89.1	CSA Z94.1-15	SHELL MATERIAL	SUSPENSION	SIZE ADJUSTMENT	BRIM	OPTIONS	AVAILABLE COLORS	PROP 65
280-HP641R-03	Class E (NON-VENTED)	Type I	•	•	HDPE	4-Point Nylon	Wheel Ratchet	Full Brim	-	Orange	⚠️ R
280-AHS240-10	Class E (NON-VENTED)	Type II	•		HDPE	6-Point Polyester Textile	Wheel Ratchet	Standard	High Strength Outer Shell with Chinstrap	White	⚠️ R

C = ⚠️ WARNING: Cancer - www.P65Warnings.ca.gov R = ⚠️ WARNING: Reproductive Harm - www.P65Warnings.ca.gov C&R = ⚠️ WARNING: Cancer and Reproductive Harm - www.P65Warnings.ca.gov

Safety Glasses



HI-VOLTAGE AC[™] 250-21-0120

Contemporary styling with bayonet temples for excellent fit



BOND[™] 250-57-0020

Lightweight nylon frame provides ultimate comfort with practically no pressure behind the ear



Q VISION 250-36-0020

Rimless design offers improved field of vision and comfort



HI-VOLTAGE ARC[™] 250-24-0300

Economic eye protection with adjustable length temples

STANDARDS MET

STYLE NUMBER	LENS	COATING	FRAME	ANSI Z87.1+	CSA Z94.3	BASE CURVE	FIT	BRIDGE	TEMPLE	PROP 65
250-21-0120	☐ Clear	Anti-Scratch / Anti-Fog	Blue	•		10	Narrow	Rubber	Bayonet, Rubber Tips	⚠️ R
250-57-0020	☐ Clear	Anti-Scratch / Anti-Fog	Dark Gray	•		8.5	Universal	Keyhole	Spatula	⚠️ R
250-36-0020	☐ Clear	Anti-Scratch / Anti-Fog	Burgundy	•		9.75	Round	Rubber	Bayonet, Co-Molded	⚠️ R
250-24-0300	☐ Clear	Anti-Scratch	Blue	•		4	Universal	Molded	Spatula	⚠️ R

C = ⚠️ WARNING: Cancer - www.P65Warnings.ca.gov R = ⚠️ WARNING: Reproductive Harm - www.P65Warnings.ca.gov C&R = ⚠️ WARNING: Cancer and Reproductive Harm - www.P65Warnings.ca.gov

ALL EYEWEAR STYLES ARE DIELECTRIC



ARC Rated Balaclavas



385-FRBL-11-NV



9100-HDFR15

ARC Rated Balaclavas

STYLE NUMBER	COLOR	WEIGHT	LAYERS	MATERIAL	PPE CATEGORY	ARC RATING	CLOSURE	SIZE
385-FRBL-11-NV	Navy	6.5 oz.	Single	FR Cotton Knit	2	11.8 cal/cm ²	Hook and Loop	S - 6XL
385-FRBL-11-OR	Orange	6.5 oz.	Single	FR Cotton Knit	2	11.8 cal/cm ²	Hook and Loop	S - 6XL
9100-HDFR12	Navy	8.5 oz.	Single	Pro-C FR Westex® Ultrasoft™	2	12.1 cal/cm ²	Hook and Loop	S - 6XL
9100-HDFR15	Navy	8.5 oz.	Single	FR Cotton Rib	2	15.1 cal/cm ²	Buckle	S - 6XL
385-HDFR13-NV	Navy	13 oz.	Double	FR Cotton / Nylon Knit	3	32.4 cal/cm ²	Buckle	S - 6XL
385-HDFR13-OR	Orange	13 oz.	Double	FR Cotton / Nylon Knit	3	32.4 cal/cm ²	Buckle	S - 6XL

ESP Kit Storage



9400-52515
Back Pack



9400-52599
Carry Bag

ESP Kit Storage

STYLE NUMBER	COLOR	STYLE	MATERIAL	FEATURE	CLOSURE	SIZE	SIZE
9400-52515	Orange	Back Pack	600 D Polyester	Insulating Glove Pocket	Zipper	20"L x 8"W x 15"H	S - 6XL
9400-52599	Orange	Carry Bag	600 D Polyester	Molded Rubber Bottom	Zipper	24"L x 10"W x 13"H	S - 6XL

Controlled Environment SAFETY

Controlled Environment refers to a work area that requires specific parameters for environmental conditions, handling, manufacturing, or testing. Typically, this covers room pressure, temperature, segregation and contamination control. Many laboratories are considered a Controlled Environment. A cleanroom is a type of Controlled Environment that requires more stringent environmental controls. This includes special equipment, processes and isolation as well as environmental air filtration meeting a higher ISO level that relates to the maximum acceptable numbers of particles (by size) in the air per cubic meter.

PIP® offers an extensive line of apparel, gloves and accessories for Controlled Environments that are designed to protect both the worker and the product by meeting multiple standards related to electrostatic discharge, contact, liquid resistance and extreme temperature handling.

Cleanroom Standards

The standards of cleanroom cleanliness are dictated by the size and quantity of particles that are present per volume of air. PIP's cleanroom PPE performs as an effective particle barrier to ensure particle emissions comply with cleanroom class specifications.

> **ISO 14644** – This standard categorizes the different sizes and amounts of airborne particles that are allowed per cubic foot within a cleanroom environment.

CLASS	FED STD 209E EQUIVALENT	0.1 MICRON	0.2 MICRON	0.3 MICRON	0.5 MICRON	1 MICRON	5 MICRON
ISO 1		10	2				
ISO 2		100	24	10	4		
ISO 3	1	1,000	237	102	35	8	
ISO 4	10	10,000	2,370	1,020	352	83	
ISO 5	100	100,000	23,700	10,200	3,520	832	29
ISO 6	1,000	1,000,000	237,000	102,000	35,200	8,320	293
ISO 7	10,000				352,000	83,200	2,930
ISO 8	100,000				3,520,000	832,000	29,300
ISO 9						8,320,000	293,000

> **IEST RP-CC005** – Test procedures for gloves and finger cots used in cleanrooms that evaluate cleanliness, barrier integrity, heat resistance, static charge, chemical compatibility and more.

Chemical Standards

PPE that acts as an effective barrier during chemical work is essential. PIP® offers specific lines of hand protection and disposable apparel that complies with the following standards:

- > **ENG 374:2003** – Evaluates the efficacy of chemical resistant gloves under continuous contact.
- > **ASTM F739 / F903** – Evaluates barrier effectiveness of PPE materials, seams and closures against liquid penetration via continuous contact.

ESD Standards

ESD safe PPE is composed of materials designed for protection against and the prevention of electrostatic discharge and is an essential part of the ESD workstation. Components work together to reduce discharge or act as a path to the ground where static electricity can be diverted. These materials are categorized by their conductive range, which include:

- > **Static Dissipative** – Materials that allow a slow, controlled flow of electric charges to the ground, preventing discharge to and from human contact.
- > **Anti-static** – Materials that have the ability to suppress charge generation or the prevention of static build up.

PIP® offers anti-static and static-dissipative gloves as well as an all-encompassing groundable static control garment system.

To successfully integrate into a professionally managed ESD program, PIP® has specific ESD Safe products that meet the following standards:

- > **ANSI/ESD S20.20** – A standard providing tailored administrative and technical requirements for the development of a comprehensive ESD control program.
- > **ANSI/ESD SP15.1** – A test procedure to measure both the intrinsic resistance and in-use electrical resistance of gloves or finger cots and personnel together as a system by using a constant area force electrode (CAFE).

PIP's ESD Safe products are an essential component of your facility's comprehensive and professionally managed ESD Program.

Microorganism Standards

To reduce the hazard of pathogen contamination, PPE materials are evaluated by resistance to liquid and viral penetration. PIP's products that protect against this contamination meet these strict guidelines:

- > **ASTM 1670** – This method is used to evaluate a material's resistance to blood penetration via continuous liquid contact.
- > **ASTM 1671** – Material resistance to the penetration of viral and bloodborne pathogens is tested by using a surrogate microbe under continuous liquid contact.

Additional Controlled Environment Standards

For Controlled Environment apparel and gloves:

- > **NFPA 99** – A standard specifying that materials should have a resistivity of $1 \times 10^{11} \Omega/\text{sq}$ at 50% relative humidity and a static decay time of less than 0.5 seconds when measured to the 10% (500 volt) cutoff level.
- > **RoHS** - Restriction of Hazardous Substances - This European standard restricts the use of ten hazardous materials in the manufacture of various types of electronic and electrical equipment. All applicable products in the EU market since July 1, 2006 must pass RoHS compliance.



Clean Handling



Scan it

General Assembly / Finishing Assembly /
Electronics Assembly / Computer Manufacturing /
Quality Control / Inspection / Paint Shop /
Pharmaceutical Production



40-C125
CLEANTEAM™
- Polyurethane coated palm and fingertips
- Can be worn under disposable and other liquid-proof gloves



40-730
CLEANTEAM™
- Reversible design
- Can be used as a glove liner



91-7
QRP™ QUALAKNIT™
- 18-gauge construction
- Lint-free
- Continuous filament



40-C2130
CLEANTEAM™
- Provides abrasion resistance
- Polyester can be sterilized
- Silicone-free



91-4
QRP™ QUALAKNIT™
- 18-gauge construction
- Lint-free
- Continuous filament

A comprehensive lineup of high gauge knit gloves for precision assembly and production

CleanTeam™ Nylon Seamless Knit

STYLE NUMBER	MATERIAL	CONSTRUCTION	COLOR	GAUGE	COATING	COATING COLOR	COVERAGE	SIZES	PROP 65
40-C125	Nylon	Seamless Knit	White	13	Polyurethane	White	Palm & Fingers	XS-2XL	⚠️ C
99-126	Nylon	Seamless Knit	White	13	Polyurethane	White	Fingertips	S-XL	⚠️ C
40-736	Nylon	Seamless Knit, Half-Finger	White	13	-	-	-	S-L	-
40-732	Nylon	Seamless Knit, Half-Finger	White	13	-	-	-	S-XL	-
40-730	Nylon	Seamless Knit	White	13	-	-	-	S-XL	-
40-750	Nylon	Seamless Knit	White	10	-	-	-	S-L	-
91-7	Nylon	Seamless Knit	White	18	-	-	-	XS-XL	-

CleanTeam™ Polyester Seamless Knit

40-C2210	Polyester	Seamless Knit	White	10	-	-	-	S-L	-
40-C2130	Polyester	Seamless Knit	White	13	-	-	-	S-XL	-
40-230	Polyester	Seamless Knit	White	13	-	-	-	S-L	-
91-4	Polyester	Seamless Knit	White	18	-	-	-	M-XL	-

C = ⚠️ WARNING: Cancer - www.P65Warnings.ca.gov R = ⚠️ WARNING: Reproductive Harm - www.P65Warnings.ca.gov C&R = ⚠️ WARNING: Cancer and Reproductive Harm - www.P65Warnings.ca.gov



ESD Safe Gloves



Scan it

Circuit Board Manufacturing / Electronics
Assembly / Aerospace / Inspection / IC Handling /
Marine, Consumer and General Electronics /
Telecommunications



40-6415 CLEANTEAM™

- ASTM D 257:2007
- ESD fiber yarns
- Polyurethane coated palm and fingertips



KAS QRP® QUALAKNIT™

- ANSI / ESD SP 15.1
- Nylon/conductive carbon fiber blend yarn
- Microknit™ fingertips



CBH3ESDCR QRP®

- UHMWPE/nylon/carbon fiber blended yarn
- Constructed from ultra-high molecular weight polyethylene



PDESDC QRP® QUALAKOTE™

- ANSI / ESD STM 11.11
- Polyurethane coated palm and fingertips
- Low linting



PDESDNY QRP® QUALAKOTE™

- ANSI / ESD SP 15.1
- Polyurethane coated palm and fingertips



PDWS QRP® QUALAKOTE™

- ANSI / ESD SP 15.1
- Anti-static black nitrile palm and fingertip coating
- Withstands wet/dry heat temps to 250°F - 275°F



TDESDNY QRP® QUALAKOTE™

- ANSI / ESD STM 11.11
- ANSI / ESD SP 15.1
- Polyurethane coated fingertips



40-6410 CLEANTEAM™

- ASTM D 257:2007/11
- Launderable and reusable without losing ESD properties
- 15-gauge for superior dexterity



ESD Safe gloves that accommodate any static range or ESD requirements within your professionally-managed ESD program

CleanTeam® Nylon ESD Safe Gloves

STYLE NUMBER	MATERIAL	CONSTRUCTION	COLOR	GAUGE	COATING	COATING COLOR	COVERAGE	SIZES	PROP 65
40-6410	Nylon / Carbon	Seamless Knit	Gray	13	-	-	-	S-2XL	-
40-6411	Nylon / Carbon	Seamless Knit	Gray	13	PVC Dot	White	Palm	S-L	-
40-6416	Nylon / Copper	Seamless Knit	Brown	13	Polyurethane	White	Fingertips	S-L	⚠️ ^C
40-6415	Nylon / Copper	Seamless Knit	Brown	13	Polyurethane	White	Palm & Fingers	S-L	⚠️ ^C
QRP® Nylon ESD Safe Gloves									
HWS	UHMWPE	Seamless Knit	Gray	13	Nitrile	Black	Palm & Fingers	S-2XL	-
KAS	Nylon / Carbon	Seamless Knit	Gray	15	-	-	-	XS-2XL	-
PDESDC	Nylon	Seamless Knit	White	13	Polyurethane	White	Palm & Fingers	XXS-2XL	⚠️ ^C
PDESDNY	Nylon / Carbon	Seamless Knit	Gray	15	Polyurethane	Light Gray	Palm	XS-3XL	⚠️ ^C
PDWS	Nylon / Carbon	Seamless Knit	Gray	13	Nitrile	Black	Palm & Fingers	XS-2XL	-
TDESDNY	Nylon / Carbon	Seamless Knit	Gray	15	Polyurethane	White	Fingertips	XS-2XL	⚠️ ^C
CBH3ESDCR	HPPE / Carbon	Seamless Knit	Salt & Pepper	15	Polyurethane	Black	Palm & Fingers	XS-2XL	⚠️ ^C

C = ⚠️ **WARNING:** Cancer - www.P65Warnings.ca.gov R = ⚠️ **WARNING:** Reproductive Harm - www.P65Warnings.ca.gov C&R = ⚠️ **WARNING:** Cancer and Reproductive Harm - www.P65Warnings.ca.gov



Inspection- Assembly Gloves

Inspection / Electronics Assembly

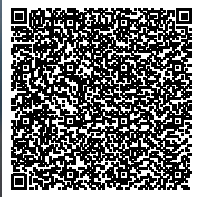

Scan it



97-500/14NI
LIGHTWEIGHT, ECONOMY
COTTON

- Designed to minimize contamination of products from human hands
- Can be used as liners under disposable and unsupported liquid proof gloves



97-500
LIGHTWEIGHT, PREMIUM
COTTON

- 100% cotton fabric
- Constructed in a two-piece, reversible pattern

Cut-and-sewn construction for optimized fit, designed to minimize contamination from human hands

CleanTeam® Cotton Seamless Knit - Lightweight, Economy

STYLE NUMBER	MATERIAL	CONSTRUCTION	HEM	LENGTH	COLOR	WEIGHT	SIZES
97-510	Cotton / Polyester	Cut-and-Sewn	Unhemmed	9"	White	Light	Men's
97-511	Cotton / Polyester	Cut-and-Sewn	Unhemmed	9"	White	Light	Ladies'
97-500I	Cotton	Cut-and-Sewn	Unhemmed	9"	White	Light	Men's
97-501I	Cotton	Cut-and-Sewn	Unhemmed	9"	White	Light	Ladies'
97-500/14I	Cotton	Cut-and-Sewn	Unhemmed	14"	White	Light	Men's
97-500/14NI	Cotton	Cut-and-Sewn	Unhemmed	14"	White	Light	Men's

CleanTeam® Cotton Seamless Knit - Lightweight, Premium

97-500	Cotton	Cut-and-Sewn	Unhemmed	9"	White	Light	Men's
97-500/10	Cotton	Cut-and-Sewn	Unhemmed	10.5"	White	Light	Men's
97-500/12	Cotton	Cut-and-Sewn	Unhemmed	12"	White	Light	Men's
97-500/14	Cotton	Cut-and-Sewn	Unhemmed	14"	White	Light	Men's
97-500J	Cotton	Cut-and-Sewn	Unhemmed	9"	White	Light	Jumbo
97-500H	Cotton	Cut-and-Sewn	Hemmed	9"	White	Light	Men's
97-501	Cotton	Cut-and-Sewn	Unhemmed	9"	White	Light	Ladies'
97-501H	Cotton	Cut-and-Sewn	Hemmed	9"	White	Light	Ladies'
97-501/10	Cotton	Cut-and-Sewn	Unhemmed	10.5"	White	Light	Ladies'
97-501/12	Cotton	Cut-and-Sewn	Unhemmed	12"	White	Light	Ladies'



97-520/12R
MEDIUM WEIGHT
COTTON

- Constructed in a two-piece, reversible pattern
- 100% cotton fabric
- Rolled hem helps shed less lint



97-540H
HEAVYWEIGHT COTTON

- Overcast hem sheds less lint
- 100% cotton fabric



98-702
SEAMLESS KNIT NYLON

- Nylon fabric absorbs perspiration and keeps hands comfortable
- Stretch fabric provides limited heat protection

Ideal for fine parts and finishing assembly

CleanTeam® Cotton Seamless Knit - Medium Weight

STYLE NUMBER	MATERIAL	CONSTRUCTION	HEM	LENGTH	COLOR	WEIGHT	SIZES
97-520	Cotton	Cut-and-Sewn	Unhemmed	9.5"	White	Medium	Men's
97-520/10	Cotton	Cut-and-Sewn	Unhemmed	10.5"	White	Medium	Men's
97-520/12	Cotton	Cut-and-Sewn	Unhemmed	12"	White	Medium	Men's
97-520/12R	Cotton	Cut-and-Sewn	Rolled	12"	White	Medium	Men's
97-520/14	Cotton	Cut-and-Sewn	Unhemmed	14"	White	Medium	Men's
97-520H	Cotton	Cut-and-Sewn	Hemmed	9.5"	White	Medium	Men's
97-520J	Cotton	Cut-and-Sewn	Unhemmed	9.5"	White	Medium	Jumbo
97-520R	Cotton	Cut-and-Sewn	Rolled	9.5"	White	Medium	Men's
97-521	Cotton	Cut-and-Sewn	Unhemmed	9"	White	Medium	Ladies'
97-521/10	Cotton	Cut-and-Sewn	Unhemmed	10.5"	White	Medium	Ladies'
97-521H	Cotton	Cut-and-Sewn	Hemmed	9"	White	Medium	Ladies'

CleanTeam® Cotton Seamless Knit - Heavyweight

97-540	Cotton	Cut-and-Sewn	Unhemmed	9"	White	Heavy	Men's
97-540/12	Cotton	Cut-and-Sewn	Unhemmed	12"	White	Heavy	Men's
97-540H	Cotton	Cut-and-Sewn	Hemmed	9"	White	Heavy	Men's
97-540R	Cotton	Cut-and-Sewn	Rolled	10"	White	Heavy	Men's
97-541	Cotton	Cut-and-Sewn	Unhemmed	8.5"	White	Heavy	Ladies'
97-541/12	Cotton	Cut-and-Sewn	Unhemmed	12"	White	Heavy	Ladies'
97-541H	Cotton	Cut-and-Sewn	Rolled	8.5"	White	Heavy	Ladies'
805	Cotton	Cut-and-Sewn	Unhemmed	10"	White	Heavy	L-XL
805L	Cotton	Cut-and-Sewn	Unhemmed	8"	White	Heavy	Ladies'

CleanTeam® Nylon Seamless Knit

905	Nylon	Cut-and-Sewn	Hemmed	9"	White	Light	Mens
906/M	Nylon	Cut-and-Sewn	Hemmed	9"	White	Light	Ladies
98-702	Nylon	Cut-and-Sewn	Zigzag Stitch	9"	White	Light	Men's
98-702/12	Nylon	Cut-and-Sewn	Zigzag Stitch	12"	White	Light	Men's
98-703	Nylon	Cut-and-Sewn	Zigzag Stitch	8.5"	White	Light	Ladies'
98-703/12	Nylon	Cut-and-Sewn	Zigzag Stitch	12"	White	Light	Ladies'
98-740	Nylon	Cut-and-Sewn	Hemmed	9"	White	Light	Men's S-2XL
98-741	Nylon	Cut-and-Sewn	Hemmed	9"	White	Light	Ladies' S-L
98-700	Nylon	Cut-and-Sewn	Zigzag Stitch	9"	White	Heavy	Men's
98-701	Nylon	Cut-and-Sewn	Zigzag Stitch	8.5"	White	Heavy	Ladies'
98-712	Nylon	Cut-and-Sewn	Zigzag Stitch	9"	White	Heavy	Men's
98-713	Nylon	Cut-and-Sewn	Zigzag Stitch	8.5"	White	Heavy	Ladies'



Single & Limited Use



Scan it

Electronics Assembly / Laboratories / Precision Optics / Pharmaceutical Manufacturing / Medical Device Manufacturing / General Cleanroom Applications



STERILE



910SC QRP® QUALATEX™

- ISO 5 (Class 100/M3.5)
- Meets or exceeds all applicable requirements of IEST RP-CC005.4
- ANSI/ESD STM 11.11

AAMI Sterility Assurance Level: 10⁻⁶

CLEANROOM



612HC QRP® QUALATEX™

- ANSI/ESD 11.11-2015
- ISO 5 (Class 100)
- Fully textured for good grip in wet or dry environments
- Lowest extractables and particulates
- Meets or exceeds all applicable requirements of IEST RP-CC005.4



100-323010 CLEANTEAM™

- ASTM D5712-05
- ASTM D 6124-01
- Exceed standards required for use in class 10 and other Controlled Environments
- 100% silicone-free



100-333010 CLEANTEAM™

- IEST RP-CC005.4
- ASTM D5712-05
- ASTM D 6124-01
- Exceed standards required for use in class 10 and other Controlled Environments
- Finger texture provides a good grip in wet or dry environments



100-2824 CLEANTEAM™

- Exceed standards required for use in class 10 and other Controlled Environments
- ESD safe for improved performance in electronics assembly
- Ambidextrous for quick and easy donning

QRP® Single-Use Sterile Latex

STYLE NUMBER	POLYMER	DESCRIPTION	GRIP	ISO CLASS	LENGTH	MIL	COLOR	SIZING	PACKAGE	PROP 65
910SC	Latex	Powder-Free	Textured	100	12"	6	White	6-9	20	-

CleanTeam® Single-Use Latex

612HC	Latex	Powder-Free	Textured Palm & Finger	100	12"	6	Natural	XS-2XL	100	-
100-323010	Latex	Powder-Free	Textured Palm & Finger	10	12"	7	Natural	S-XL	100	-
100-322400	Latex	Powder-Free	Textured Palm & Finger	100	9.5"	7	Natural	S-XL	100	-
100-323000	Latex	Powder-Free	Textured Palm & Finger	100	12"	7	Natural	S-XL	100	-

CleanTeam® Single-Use Nitrile

100-333010	Nitrile	Powder-Free	Textured Palm & Finger	10	12"	5	White	S-XL	100	-
100-332400	Nitrile	Powder-Free	Textured Palm & Finger	100	9.5"	5	White	S-XL	100	-
100-333000	Nitrile	Powder-Free	Textured Palm & Finger	100	12"	5	White	S-XL	100	-

CleanTeam® Single-Use Vinyl

100-2824	Vinyl	Powder-Free	Smooth	10	9.5"	5	Clear	S-XL	100	⚠️ C&R
100-2830	Vinyl	Powder-Free	Smooth	10	12"	5	Clear	S-XL	100	⚠️ C&R

C = ⚠️ WARNING: Cancer - www.P65Warnings.ca.gov R = ⚠️ WARNING: Reproductive Harm - www.P65Warnings.ca.gov C&R = ⚠️ WARNING: Cancer and Reproductive Harm - www.P65Warnings.ca.gov



ESD SAFE CLEANROOM GLOVES



QRP® QUALATRILE®
 IEST RP-CC005.4
 - Naturally anti-static
 - Manufactured without plasticizers, silicone or powders
 - Finger texture provides a good grip in wet or dry environments



ESD125
 QRP® QUALATRILE®
 - ANSI 5 (Class 100)
 - IEST RP-CC005.4
 - ESD Safe for improved performance in electronics assembly



AF125
 QRP® QUALATRILE®
 - ISO 5 (Class 100)
 - IEST RP-CC005.4
 - Accelerator free formulation lowers risk of dermatitis potential

ESD SAFE GLOVES

ESD safe with consistently low particulates and extractable ion levels



BQF09
 QRP® QUALATRILE®
 - ANSI ESD S11.11
 - ESD STN 11.12
 - 21 CFR 177 for food handling
 - Powder-free



SQWF09
 QRP® QUALATRILE® SENS!
 - GeoGrip 360 fully textured fingers and palm for good wet/dry grip
 - 3x the puncture resistance of vinyl or latex

QRP® Single-Use Nitrile ESD Safe Gloves

STYLE NUMBER	21CFR	ESD SAFE	POLYMER	DESCRIPTION	GRIP	ISO CLASS	LENGTH	MIL	COLOR	SIZING	PACKAGE	CLEANROOM	PRDP 65
AF125	-	-	Nitrile	Powder-Free	Textured	100	12"	6	White	XS-XL	100	-	-
Q095	-	-	Nitrile	Powder-Free	Textured Fingers	100	9"	5	White	XS-2XL	100	-	-
Q124	-	-	Nitrile	Powder-Free	Textured	10	12"	5	White	XS-2XL	100	-	-
Q125	-	-	Nitrile	Powder-Free	Textured	100	12"	6	White	XS-2XL	100	-	-
ESD125	-	-	Nitrile	Powder-Free	Textured	100	12"	6	White	XS-XL	100	-	-
4BQF09	Yes	Yes	Nitrile	Powder-Free	Textured	-	-	4	Blue	XS-2XL	100	No	-
BQP09	Yes	Yes	Nitrile	Low Powder	Textured	-	-	5	Blue	XS-2XL	100	No	-
BQF09	Yes	Yes	Nitrile	Powder-Free	Textured	-	-	5	Blue	XS-2XL	100	No	-
BQF12	Yes	Yes	Nitrile	Powder-Free	Textured	-	-	5	Blue	XS-2XL	100	No	-
8BQP09	Yes	Yes	Nitrile	Low Powder	Textured	-	-	8	Blue	XS-XL	100	No	-
8BQF09	Yes	Yes	Nitrile	Powder-Free	Textured	-	-	8	Blue	XS-XL	100	No	-
BQY09	Yes	Yes	Nitrile	Powder-Free	Textured	-	-	4	Blue	S-2XL	100	No	-
SQWF09	No	Yes	Nitrile	Powder-Free	Textured	-	-	3	White	S-XL	100	No	-
SQBF09	No	Yes	Nitrile	Powder-Free	Textured	-	-	3	Blue	S-XL	100	No	-
ESD095	-	-	Nitrile	Powder-Free	Textured	100	9"	6	White	XS-XL	100	-	-

QRP® Single-Use Vinyl ESD Safe Gloves

VCF09	-	-	Vinyl	Powder-Free	Textured Palm & Finger	-	-	4 mil	Clear	S-2XL	100	Yes	⚠️ C&R
VHC12	-	-	Vinyl	Powder-Free	Textured Palm & Finger	100	12"	5	Clear	S-XL	100	Yes	⚠️ C&R

⚠️ **WARNING:** Cancer - www.P65Warnings.ca.gov

⚠️ **WARNING:** Reproductive Harm - www.P65Warnings.ca.gov

⚠️ **WARNING:** Cancer and Reproductive Harm - www.P65Warnings.ca.gov



Acid and Solvent Resistant Series for Cleanroom

Precision Parts Cleaning / Electro-Chemical Polishing / Optics / Disk Drives / Semiconductors / Transistors / Metal Etching / Chemical Handling



Scan it

Provides secure protection from a wide variety and concentration of chemicals



SOLVENT SERIES

20G

POLYTUFF POLYURETHANE

- Excellent resistance to punctures, snags and abrasion, coupled with high tactile sensitivity
- Protection from chlorinated solvents (MeCl and TCE), acetone, xylene, freons and IPA
- Meets or exceeds all applicable requirements of IEST-RP-CC005.4



ACID SERIES

41G

POLYTUFF CSM

- Provides secure protection from a wide variety and concentration of chemicals
- Engineered for corrosive alkalis and ultra-strong acids using HypalonR
- Excellent handling in wet or dry environments
- EN 374 compliant

ESD GLOVES with solvent resistance



SOLVENT SERIES

25G

POLYTUFF POLYURETHANE

- ANSI/ESD S20.20
- For use with Class II static sensitive devices (thresholds above 1000V)
- Compliant with ASTM and IEST-RP-CC005.4 standards
- Resists common solvents such as MeCl, TCE and IPA



SOLVENT SERIES

27G

POLYTUFF POLYURETHANE

- Tough, sheer PolyTuff polyurethane film affords a high degree of tactile sensitivity
- ESD safe compliance to ANSI/ESD S20.20-2014
- Compliant with ASTM and IEST-RP-CC005.4 standards

Polytuff Acid and Solvent Resistant Gloves

STYLE NUMBER	POLYMER	DESCRIPTION	GRIP	ISO CLASS	LENGTH	MIL	RESISTANCE TYPE	COLOR	SIZING	PACKAGE
20G	Polyurethane	Powder-Free	Smooth	100	12"	8 mil	Solvents	Clear	S-XL	5 pair
41G	CSM	Powder-Free	Smooth	100	14"	15 mil	Alkalis and Acids	White	L	1 pair
90G	Silicon	Powder-Free	Smooth	100	12"	30 mil	Solvents	Clear	L	1 pair

Polytuff Solvent ESD Safe Gloves

25G	Polyurethane	Powder-Free	Smooth	100	12"	4 mil	Solvents	Clear	S-XL	5 pair
27G	Polyurethane	Powder-Free	Smooth	100	12"	4 mil	Solvents	Black	S-XL	5 pair
28G	Polyurethane	Powder-Free	Smooth	100	12"	8 mil	Solvents	Black	S-XL	5 pair



Finger Cots



Scan it

Precision Parts Assembly / Laboratory /
Beauty Industry / Food Industry / Avionics /
IC Industries / Electronic Assembly /
Cleanroom Applications

ESD PROPERTIES OF FINGER COTS

Anti-static materials have the ability to suppress charge generation or prevent static build up. Anti-static latex finger cots are treated with a proprietary surface treatment for enhanced ESD performance. Nitrile finger cots are naturally anti-static.

Static dissipative materials allow a slow, controlled flow of charge to the ground, preventing electric discharge. ESD latex finger cots incorporate a carbon pigment, making them inherently static dissipative.



6C
QRP® QUALATEX®
- IEST RP-CC005.4
- 21 CFR 170
- Miracle Grip polymer coating provides an enhanced wet/dry grip
- Sheer film for maximum dexterity
- Made of 100% natural latex in rolled style



BF
QRP® BLU FOOD™
- Made of 100% natural latex in rolled style
- USDA compliant blue color
- 21 CFR 170 compliant
- Powder-free



5C
QRP® QUALASHEER® XC
- ISO 5 (Class 100)
- IEST RP-CC005.4
- 21 CFR 170
- Eliminates contamination risks from silicone oils, skin salts, particulates and plasticizers



7C
QRP® QUALATEX®
- ISO 5 (Class 100)
- ESD Safe to ANSI/ESD S20.20
- Compliant with ASTM and IEST-RP-CC 005.4 standards



8C
QRP® QUALATEX®
- ISO 5 (Class 100)
- ESD Safe to ANSI/ESD S20.20
- Compliant with ASTM and IEST-RP-CC 005.4 standards



9C
QRP® QUALATRILE®
- ISO 5 (Class 100)
- ESD safe compliance to ANSI/ESD S20.20
- Compliant with ASTM and IEST-RP-CC 005.4 standards

QRP® Latex Finger Cots

STYLE NUMBER	POLYMER	POWDER	ISO CLASS	GRIP	MIL	COLOR	SIZING	COTS/PACK
6C	Latex	Powder-Free	-	Textured	3.5	Ivory	S-XL	720
BF	Latex	Powder-Free	-	Textured	3.5	Blue	S-XL	720
QRP® Qualatex® Latex Cleanroom Finger cots								
5C	Latex	Powder-Free	100	Textured	3.5	Ivory	S-XL	720
5J	Latex	Powder-Free	100	Textured	3.5	Ivory	S-XL	720
QRP® Qualatex® Latex Cleanroom (ESD Safe)								
7C	Latex	Powder-Free	100	Textured	3.5	Pink	S-XL	720
7J	Latex	Powder-Free	100	Textured	3.5	Pink	S-XL	720
8C	Latex	Powder-Free	100	Textured	3.5	Black	S-XL	720
8J	Latex	Powder-Free	100	Textured	3.5	Black	S-XL	720
QRP® Qualatril® Nitrile Cleanroom (ESD Safe)								
9C	Nitrile	Powder-Free	100	Textured	3.5	White	S-XL	720
9J	Nitrile	Powder-Free	100	Textured	3.5	White	S-XL	720



Polymer Gloves

Industrial Painting Precision / Parts Cleaning / De-greasing /
Laboratory / Electro-Chemical Polishing / Automotive /
Aircraft Maintenance / Propellant Manufacturing



Scan it



550

QRP® POLYTUFF® POLYURETHANE

- Superior protection from acids
- Effective against paint thinner
- 100% cotton knit lined for extra comfort and protection



3000

QRP® POLYTUFF®
ESD POLYURETHANE

- Static dissipative
- Excellent resistance to a broad range of solvents
- Sulfur-free, no carbon shedding

Application-specific gloves that provide superior chemical protection

QRP® Polytuff® Polyurethane

STYLE NUMBER	POLYMER	GRIP	LENGTH	CONSTRUCTION	LINER	COLOR	SIZING	PACKAGING
400	Polyurethane	Smooth	10.25"	Supported	Cotton	Green	S-XL	1pr/case
440	Polyurethane	Smooth	13"	Supported	Cotton	Green	S-XL	1pr/case
440-55	Polyurethane	Smooth	19"	Supported	Cotton	Green	L	30 pairs/case
550	Polyurethane	Smooth	13"	Supported	Cotton	White	L	1pr/case

QRP® Polytuff® Polyurethane ESD Safe

3000	Polyurethane	Smooth	10.25"	Supported	Cotton	Black	L	1pr/case
3300	Polyurethane	Smooth	13"	Supported	Cotton	Black	L	1pr/case
300	Polyurethane	Textured	10.25"	Supported	Cotton	Black	L-XL	50 pairs/case
300WN	Polyurethane	Textured	10.25"	Supported	Wool	Black	L-XL	50 pairs/case



Thermal Gloves & Aprons

Scan it

THERMAL GLOVES

-210°F – 1400°F (-134°C – 760°C)



50G
QRP® QUALATHERM®
- ISO 5 (Class 100)
- ESD safe static dissipative
- ESD safe compliance to ANSI/ESD S20.20-2014
- No PCB, asbestos or fiberglass

-210°F – 1000°F (-134°C – 537°C)



59G
QRP® QUALATHERM®
- ISO 5 (Class 100)
- High contact temperature with no charring, ash or residue
- No PCB, asbestos or fiberglass

-78°F – 450°F (-61.4°C – 232°C)



74G
QRP® QUALATHERM®
- Liquid resistant
- Suitable for use in cryogenic areas
- ISO 5 (Class 100)
- Silicone elastomer is sulfur-free
- Excellent resistance to chemicals, solder and fluxes

THERMAL APRON

202-2036
QRP®

- Multi-layered construction for maximum thermal protection
- Superior flexibility that will not stiffen at extreme temperatures
- Liquid-proof outer layer to protect from splashes



GLOVE AND APRON SET

- Impermeable glove and apron set that adds an extra layer of protection against volatile solvents
- Sulfur-free
- To be used with QRP® Solvent Series



T1



T2

STYLE NUMBER	TYPE	COLOR	MATERIAL	LENGTH	SIZES
T1	Glove	Blue	EVOH / Polyethylene	16"	M-L
T2	Apron	Blue	EVOH / Polyethylene	OS	-

Thermal Aprons

STYLE NUMBER	COLOR	MATERIAL	LENGTH	SIZES	GOOD FOR			
					EXTREME TEMPERATURE	LIQUID & CHEMICAL RESISTANT	DRY THERMAL PROTECTION	WET/DRY THERMAL PROTECTION
202-2036	Black	Liquid-Proof Silicone	36"	-	•	•		•
202-2042	Black	Liquid-Proof Silicone	42"	-	•	•		•
202-2048	Black	Liquid-Proof Silicone	48"	-	•	•		•
202-2054	Black	Liquid-Proof Silicone	54"	-	•	•		•

Thermal Gloves

49G	Yellow	Kevlar®/Nomex®	Mid-Arm	M-XL	•		•	
50G	Brown	PBI / Wool / Nylon	Mid-Arm	M-XL	•		•	
55G	Brown	PBI / Wool / Nylon	Elbow	L	•		•	
57G	Brown	PBI / Wool / Nylon	Shoulder	L	•		•	
59G	Yellow	Twaron / Nylon	Mid-Arm	L-XL	•		•	
70G	White	Silicone / Nylon	Wrist	M-XL	•	•		•
73G	White	Silicone / Nylon	Wrist	OS	•	•		•
74G	White	Silicone / Nylon	Mid-Arm	L-XL	•	•		•
75G	Natural	Silicone / Nylon	Elbow	L	•	•		•
102	Yellow	Polyurethane	11"	L-2XL	•			•
103	Yellow	Polyurethane	11"	XL	•			•
104	White	Polyurethane	11"	L-XL	•			•



Dry Box & Isolator Gloves and Sleeves

Laboratories / Pharmaceutical Manufacturing
Biomedical Research / Biotech and Chemical Research



Dry Box And Isolator Gloves & Sleeves

DRY BOX	POLYMER	THICKNESS	SIZES	LENGTHS	PORT SIZES	COLOR	ESD
DBG-BT15/8-8.5	Butyl (BT)	15 mil	8	32"	8.5"	Black	Yes
DBGBT-15249.75	Butyl (BT)	15 mil	9.75	32"	12"	Black	Yes
DBG-BT156-8	Butyl (BT)	15 mil	8	32"	6"	Black	Yes
DBG-BT24/8-10.5	Butyl (BT)	24 mil	10.5	32"	8"	Black	Yes
DBG-BT246-8.5A	Butyl (BT)	24 mil	8.5	32"	6"	Black	Yes
DBG-BT-30-9.75	Butyl (BT)	30 mil	9.75	32"	8"	Black	Yes
DBG-HY15/6-8.5	Chlorosulfonated Polyethylene (CSM)	15 mil	8.5	32"	6"	Opaque	No
DBG-CSM7-9.75A	Chlorosulfonated Polyethylene (CSM)	15 mil	9.75	32"	7"	Opaque	No
DBG-CSM-15-9.75	Chlorosulfonated Polyethylene (CSM)	15 mil	9.75	32"	10"	Opaque	No
DBG-CSM-20-10.5	Chlorosulfonated Polyethylene (CSM)	20 mil	10.5	32"	8"	Opaque	No
Isolator Gloves							
LG-HY15/M	Chlorosulfonated Polyethylene (CSM)	15 mil	M	15"	-	Opaque	No
IG-HY15-9	Chlorosulfonated Polyethylene (CSM)	15 mil	9	15"	-	Opaque	No
IG-BT15-9A	Chlorosulfonated Polyethylene (CSM)	15 mil	9	15"	-	Opaque	No
Isolator Sleeves							
SL-CSM_24/7	Chlorosulfonated Polyethylene (CSM)	24 mil	-	24"	7"	Opaque	No

Custom Specifications

Dry Box Gloves

THICKNESS	HAND SIZES	LENGTHS	PORT SIZES	COLORS
15 mil	6 - 8.5	-	6" - 10"	White
20 mil	9 - 10.5	-	12" - 13"	Blue
24 mil	11	-	-	Black
30 mil	-	-	-	-

Isolator Gloves

THICKNESS	HAND SIZES	LENGTHS	PORT SIZES	COLORS
12 mil	5 - 11	15"	-	Black
20 mil	-	-	-	-
28 mil	-	-	-	-

Isolator Sleeves

THICKNESS	HAND SIZES	LENGTHS	PORT SIZES	COLORS
15 mil	-	24"	6" - 10"	Black
20 mil	-	-	12"	-
24 mil	-	-	-	-
30 mil	-	-	-	-

Custom Glove & Sleeve Polymers

STYLE PREFIX	AVAILABLE POLYMERS	ATTRIBUTES
NR	Natural Rubber	- Dry box gloves only - Resistant to diluted acids and alkalis
BT	Butyl	- ESD - Low gas permeability - Excellent chemical resistance
NE	Neoprene	- ESD - High dexterity and flexibility - Superior tensile strength*
CSM	Chlorosulfonated Polyethylene	- Resistant to acids, alkalis and salts - Heat resistant - Enhanced durability with high resistance to aging and weathering
PU-CSM	Polyurethane Chlorosulfonated Polyethylene	- Superior chemical resistance - Excellent resistance to cuts and punctures - Enhanced durability with high resistance to aging and weathering
PU	Polyurethane	- Excellent tear and abrasion resistance - Enhanced durability with resistance to aging and weathering - Superior resistance to aliphatic solvents
EPDM	Ethylene-Propylene Diene Monomer	- Resistant to many chemicals - Excellent resistance to oxygen, ozone and UV exposure - Electrical insulator



Contamination Control Mats

Specially designed adhesive coated mats reduce foot borne dust and particulates from entering cleanrooms and Controlled Environments.



Scan it



Contamination Control Mats

STYLE NUMBER	SIZE	LAYERS	COLORS	WEIGHT	PACKAGING
100-93-183638	18" x 36"	30	Blue, Gray and White	-	8
100-93-184538	18" x 45"	30	Blue, Gray and White	-	8
100-93-243638	24" x 36"	30	Blue, Gray and White	-	8
100-93-264538	26" x 45"	30	Blue, Gray and White	-	8
100-93-264564	26" x 45"	60	Blue, Gray and White	-	4
100-93-363638	36" x 36"	30	Blue, Gray and White	-	8
100-93-364538	36" x 45"	30	Blue, Gray and White	-	8
100-93-364564	36" x 45"	60	Blue, Gray and White	-	4
100-93-366064	36" x 60"	60	Blue and Gray	-	4

Cleanroom Paper

100-95-501	8.5' x 11"	-	Blue, Gray, Pink, Yellow, White	22#	250 sheets per pack, 10 packs per case
-------------------	------------	---	---------------------------------	-----	--



CLEANROOM PAPER



Scan it



Reusable Garments

Cleanroom / ESD Assembly / Paint Spray

CLEANROOM COVERALLS



CCRC-89WH-5PK

- Meets ANSI S20.20
- Military collar
- Snaps at top of zipper, leg hems and back of legs
- Raglan sleeves

CC1245-74WH-5PK

- Military collar with color coded hang loop
- Snaps at top of zipper, leg hems and back of legs
- Raglan sleeves

PAINTSPRAY COVERALLS



CCNCHR-62NV-5PK NAVY

- Hidden snaps at front waistline, hidden snaps and tabs on inside back waist
- Mesh full upper back, webbing loops on sleeve seam and back right waist
- 1 inside chest pocket with flap, 2 back pockets with flaps

CCNCHR-62RB-5PK ROYAL BLUE

Cleanroom Coveralls

STYLE NUMBER	COLOR	GARMENT	CONFIGURATION	CLOSURE	FABRIC/SOLE	ESD YARN PATTERN	SIZES
CC1245-74WH-5PK	White	Coverall - Cleanroom	Military Collar, Zip Front, Knit Cuffs, Snaps at leg hems and back of legs	Zipper	Atlessa Grid	Grid	S-3XL
CC1245-74LB-5PK	Light Blue						
CC1245-74NV-5PK	Navy						
CCRC-89WH-5PK	White	Coverall - Cleanroom	Military Collar, Zip Front, Knit Cuffs, Snaps at leg hems and back of legs	Zipper	Disctek 2.5mm Grid	2.5 mm Grid	S-3XL
CCRC-89LB-5PK	Light Blue						
CCRC-89NV-5PK	Navy						

Paintspray Coveralls

CCNCHR-62NV-5PK	Navy	Coverall - Paintspray	Auto Grid Navy Coverall with Raglan Sleeves, Double Zipper and Snap Front and Pockets	Zipper and Snap	Auto Grid	Grid	S-3XL
CCNCHR-62RB-5PK	Royal Blue	Coverall - Paintspray	Royal Blue Coverall with Raglan Sleeves, Double Zipper and Snap Front and Pockets	Zipper and Snap	Auto Grid	Grid	S-3XL





CLEANROOM HEAD & FOOT COVERS



CHB-75WH-20PK
Bouffant Cap



CSC-60-5PK
Shoe Covers

CLEANROOM FROCKS



CFRZC-74LB-5PK
LIGHT BLUE

CFRZC-74NV-5PK
NAVY

CFRZC-74WH-5PK
WHITE

SITWEAR

HSCBM1P/HSCTM3-49NV-5PK

Top

- Bound neck
- Raglan sleeve, knit cuff wrists
- Slits at bottom of side seam

Bottom

- Elastic waist with color-coded hang loop
- Half elastic, half snap ankle



CCNCHR-62NV



CFRZC-16WH-5PK



CFR-60WH-5PK

Cleanroom Head & Foot Covers

STYLE NUMBER	COLOR	GARMENT	CONFIGURATION	CLOSURE	FABRIC/SOLE	ESD YARN PATTERN	SIZES
CHB-75WH-20PK	White	Bouffant Cap	Tricot White 21" Bouffant Cap	-	Tricot	Non-ESD	21"
CSC-60WH-20PK	White	Shoe Covers	Basic Shoe Covers, Encased Elastic Opening, Snaps at Back, Hypalon Soft Sole	Snaps	Taffeta/Hypalon Sole	Non-ESD	S-3XL
CSC-60LB-20PK	Light Blue						
CSC-60NV-20PK	Navy						

Cleanroom Frocks

CFRZC-74WH-5PK	White	Frock	Military Collar, Zip Front, Knit Cuffs	Zipper	Altesa Grid	Grid	S-3XL
CFRZC-74LB-5PK	Light Blue						
CFRZC-74NV-5PK	Navy						
CFR-60WH-5PK	White	Frock	Military Collar, Snap Front, Snap Cuffs	Snap	Taffeta	Non-ESD	S-3XL
CFRZC-16WH-5PK	White	Frock	Military Collar, Zipper, Snap Cuff	Zipper	Ultimax Stripe	Stripe	S-3XL
CFRZC-74WH-5PK	White	Frock	Military Collar, Snap Front, Snap Cuffs	Snap	Altesa Grid	Grid	S-3XL

Sitewear

HSCBM1P/HSCTM3-49NV-5PK	Navy	Sitewear Top and Bottom	Top: Raglan Sleeves, Placket Snap Front, Knit cuffs, Bound Neck, Slits at Bottom of Side Seams Bottom: Comfort 1" Elastic Waist, Combo Elastic and Snap Adjustment at Leg Hems	Top: Snap Bottom: Elastic	Microdenier	Non-ESD	S-3XL
--------------------------------	------	-------------------------	--	---------------------------	-------------	---------	-------



Scan it

Accessories

FACE MASKS



FACEMASK-3PWSOP-ES
Class 10-100

FACEMASK-3PWSOP
Class 1,000-10,000

WIPES



WIPE-9X9D
9" x 9"

WIPE-9X9PS
9" x 9"
Pre-Saturated

WIPE-12X12D
12" x 12"

WIPE-12X12PS
12" x 12"
Pre-Saturated

WIPE-9X9ST
9" x 9"
Sterile

SWABS



SWAB-3
3" Swab



SWAB-6
6" Swab

PENS



CR-BALL-PEN

COLORS AVAILABLE:

Black  Blue  Red 

Face Masks

STYLE NUMBER	MATERIAL	DESCRIPTION	PACK
FACEMASK-3PWSOP	Hypoallergenic, Middle layer: 100% Polypropylene, Inner Layer: 100% Polypropylene, Outer layer: 100% Polypropylene	Class 1,000-10,000 Disposable Face Mask	50 / Box
FACEMASK-3PWSOP-ES	Lint Free, Middle layer: 100% Polypropylene, Outer layer-ES: 50% Polypropylene/50% Polyethylene	Class 10-100 Disposable Face Mask	50 / Box

Swabs

STYLE NUMBER	MATERIAL	SILICONE FREE	SIZE
SWAB-3	Polurethan foam; Polypropylene handles	Yes	3" length
SWAB-6	Polurethan foam; Polypropylene handles	Yes	6" length

Wipes

STYLE NUMBER	MATERIAL	CLASS	SIZE
WIPE-9X9D	100% Polyester	10-100	9" x 9"
WIPE-9X9PS	Pre-Saturated 100% Polyester	10-100	9" x 9"
WIPE-12X12D	100% Polyester	10-100	12" x 12"
WIPE-12X12PS	Pre-Saturated 100% Polyester	10-100	12" x 12"
WIPE-9X9ST	100% Polyester, Sterile	10-100	9" x 9"

Pens

STYLE NUMBER	MATERIAL	CLASS	COLORS AVAILABLE
CR-BALL-PEN	ESD ABS	100	Black, Blue, Red



PROTECTIVE INDUSTRIAL PRODUCTS

When it gets
challenging.
A trusted partner
makes the difference.





PROTECTIVE INDUSTRIAL PRODUCTS

Vend-ready solutions

PACKAGED FOR VENDING MACHINES



FREQUENTLY USED ITEMS



OPTIMALLY SIZED FOR MOST MACHINES



BARCODED PACKAGING FOR INVENTORY CONTROL

The most comprehensive line of vend packed PPE

MANY OF PIP'S PRODUCTS ARE VEND-READY IN THEIR STANDARD PACKAGING



WE CAN MAKE ALMOST ANYTHING VEND-READY

Our Black Pearl manufacturing facility specializes in custom logoing, packaging and testing. We can do any configuration to meet your unique needs.



STOCKED & READY TO SHIP VEND-READY GLOVES

More than twenty of our most popular glove styles are now available in vend-ready packaging. These are stocked and ready to go. Consistent width and thickness ensure proper dispensing.

HI-VIS VESTS AND T-SHIRTS

All PIP® Hi-Vis Vests and T-shirts are or soon will be in vend-ready packaging! See page 145 for our complete product selection.

BOUTON® OPTICAL

All PIP® safety glasses and goggles are vend-ready! See page 121 for our complete product selection.



Retail ready solutions

TAILORED TO YOU. FOR YOU. BY YOU.

Customized Retail Ready™ Program

PIP® IS YOUR SAFETY PRODUCT PARTNER FOR MAXIMIZING YOUR SHOWROOM PRODUCT SALES

No two showrooms are the same, sometimes constricted by space and other times by location, it is our job to adapt to your needs. That's what PIP's customized Retail Ready™ Program is all about.

More than 30 years of industrial and do-it-yourself retail market experience has allowed us to develop an extensive line of PPE that's individually packaged and ready to retail, out the door.



SHELF TALKER



BASKET TALKER



PEG TALKER

PIP® RETAIL READY DISPLAY TALKERS

Laminated and durable, these display talkers come complete with mounting ties and highlight features that resonate with customers. Clear bullet points identify the product, key features and ideal use. That's all that's needed to make the difference.



THINK LIKE A RETAILER

To do Retail Ready right, you have to think like a retailer. It's all about taking advantage of seasonality and trends. PIP® already offers you the most comprehensive early buy program in the industry. We now include separate early buy special point-of-sale deals that are tailored to take maximum advantage of your walk-in traffic. Take for example the first storm of winter; think of how many customers forget their gloves. Maximize sales with a winter glove rack sitting on your counter ready to pump those impulse sales.

EYE-CATCHING POINT-OF-PURCHASE DISPLAYS ARE THE KEY

Standard available displays are meant to be versatile and adaptable in all showrooms.



GONDOLA DISPLAY



TOWER DISPLAY



DUMP DISPLAY

CUSTOMIZED PLANOGRAMS JUST FOR YOU

PIP® can tailor your slat wall or gondola display unit to hold key products. With more than 30 years of experience and core expertise in our consumer products division, we're here to help you put together a fast-turning product configuration that meets your needs.



Working with your PIP® sales representative, we can provide you with top sellers in each market channel and recommendations for optimizing your point-of-purchase displays.



PROTECTIVE INDUSTRIAL PRODUCTS

Custom imprinting

FAST. DEPENDABLE. QUALITY PRINTING.



Custom imprinting is available on most safety eyewear, hard hats, gloves, vests, t-shirts, sweatshirts, jackets, cooling towels and bandanas.

WE USE THE MOST ADVANCED TECHNIQUE AND QUALITY INK THAT ENSURES YOUR LOGO POPS AND WILL NOT WEAR OFF. IT'S NOT JUST OUR IMAGE - IT'S YOURS TOO.



EXPERIENCE

THE DIFFERENCE

FAST, EASY AND PRECISE. If you don't associate these words with your custom order requests, you're not taking advantage of PIP's logo and imprinting services. With exceptionally quick turnaround times and high-quality results, PIP® delivers the value-added service you and your customers expect. Put us to the test on your next logo order and experience the difference.

6-DAY TURNAROUND TIME



STATE-OF-THE-ART FACTORY

- > 6-day turnaround*
- > Low minimums
- > Over 12 standard PMS colors available
- > Ordering software backed by a specialized core team

* Following approval of logo artwork

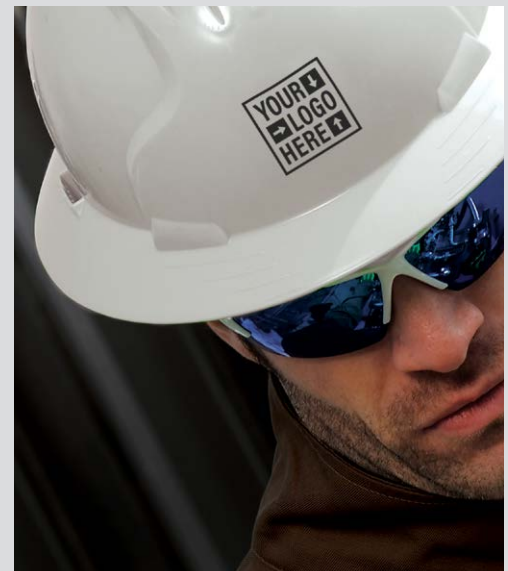

MORE THAN 40% OF COMMON PPE IS LOGOED

- > Builds brand presence
- > Promotes security on job sites
- > Reduces waste



PROTECTIVE INDUSTRIAL PRODUCTS

Custom options

FOR ENHANCED PERFORMANCE



Customized Arm Protection

When it comes to arm protection, you don't have to settle for what's already out there. Identify your safety need, then customize your solution by choosing the material, size, and option(s) to maximize performance.

Call PIP® at (800) 262-5755
For part numbers and pricing for your order,
or if a custom option you need is not listed on this page.

Orders will ship within 2 weeks or up to 4 weeks for Pritex® sleeves.

CUSTOM OPTIONS

Several customizable options are available to help maximize protection by ensuring that the sleeve stays in place as consistently as possible. Thumb holes or thumb slots can help hold the sleeve up to the heel of your hand while elastic bands or hook and loop closures help hold the sleeve up your arm.

WHAT'S THE APPLICATION?

Protective sleeves are designed to help prevent abrasions and scrapes. Protection can be enhanced by refining your selection based on the application.



CUT PROTECTION



HEAT PROTECTION



ARC FLASH PROTECTION



FOOD HANDLING



GENERAL PURPOSE

FINGER & THUMB



THUMB HOLE THUMB SLOT



ELASTIC THUMB HALF THUMB



FINGER BAR TACKS

TOP OF THE ARM



NONSLIP TOP 2" BLUE/GOLD ELASTIC



3/4" WHITE ELASTIC VELCRO CLOSURE



NYLON STRAP W/RING & CLIP DOUBLE CLIP & RING



PROTECTIVE INDUSTRIAL PRODUCTS

#1 go-to website

WWW.PIPUSA.COM

Four easy ways to find the perfect product

1 SEARCH THE
PRODUCT
SELECTOR GUIDE

2 BROWSE BY
PRODUCT
CATEGORY

3 BROWSE BY
INDUSTRY
CHANNEL

4 SEARCH BY
SKU
NUMBER

WEBSITE FEATURES



DOWNLOAD SPEC SHEETS & LITERATURE

All the valuable information you need at your fingertips. Helping you lose those stacks of papers with easy to download spec sheets and literature.



VIDEO FEATURETTES

Informative, short videos that pack a lot of punch and are loaded with product features and benefits.



INFORMATIVE ICONS

What does that icon or rating mean? Scroll over our enhanced icons to learn more about our products' capabilities.



WORLDWIDE LOCATIONS

Conducting international business? We provide country and language-specific websites for more than 10 countries.



TOUCHSCREEN FRIENDLY

Access our website on the go from your smart phone or tablet without losing any of the website's capabilities.

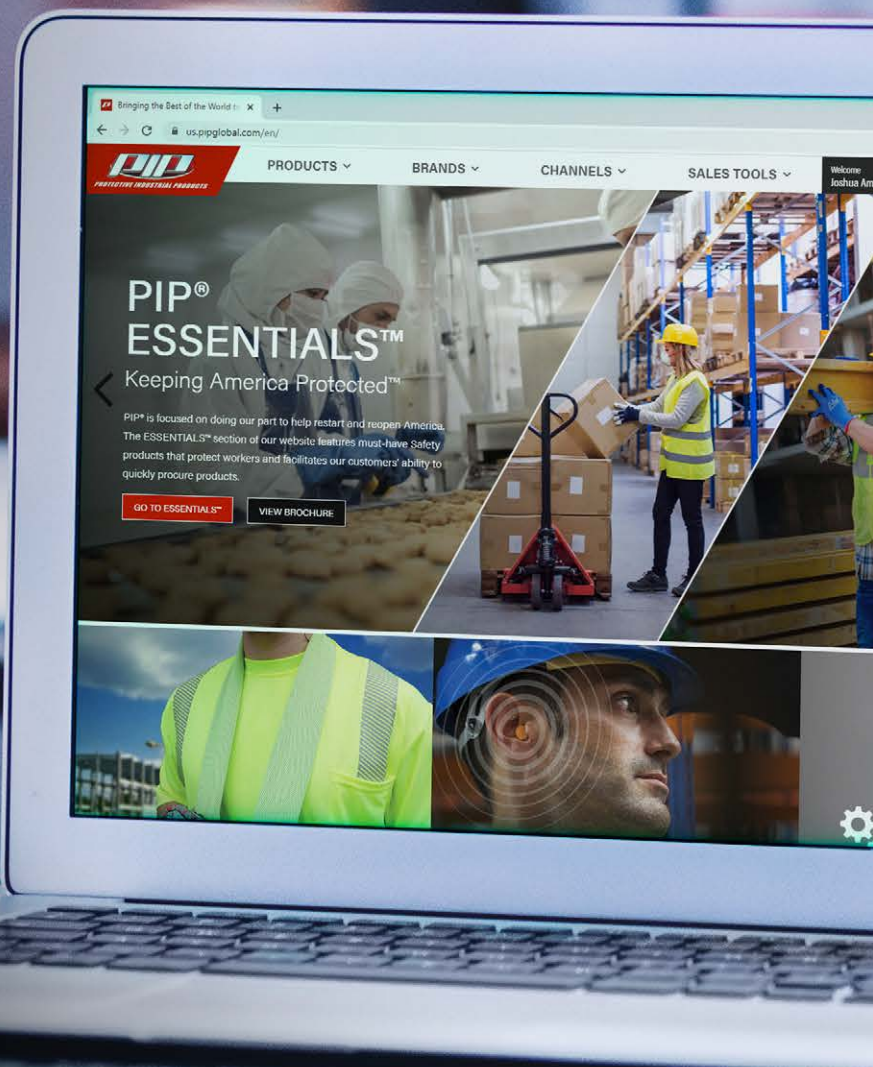



Industry-Leading Sales Tools

INTERACTIVE SALES TOOLS INCLUDE



CUT RISK HAZARD MATRIX™



INTERACTIVE CROSS-REFERENCE



SELECTOR GUIDES



3SP™ ASSESSMENT



INTERACTIVE PRODUCT PRESENTATIONS

Our innovative interactive Sales Tools help Safety Specialists make fast, accurate decisions and product recommendations based on the customer's essential safety needs to ensure they're using the PPE that's best suited for their job.





PROTECTIVE INDUSTRIAL PRODUCTS

Programs that work for you

SIMPLE SAFETY SOLUTIONS



3SP™

3SP™ is a multifaceted, learning-based program designed and tailored to meet the needs of our customers.



DESIGNED TO HELP US
KNOW MORE AND
LEARN FASTER



SAVE MONEY AND HELP
REDUCE INJURIES THROUGH
PREVENTION
AND PROPER PRODUCT
SELECTION AND USE

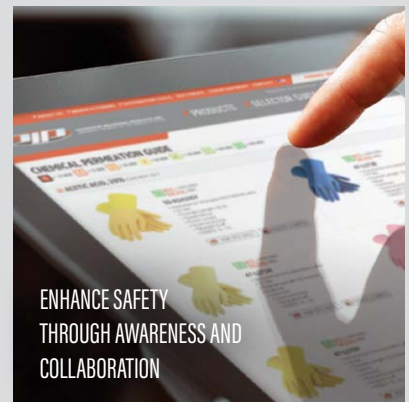

ENHANCE SAFETY
THROUGH AWARENESS AND
COLLABORATION

Assessment

ON-SITE ASSESSMENT SURVEY

Working collaboratively with our distributor-partners, we perform all 3SP™ site surveys. This assures industrial customers that they are done effectively and without any downtime. 3SP™ trained representatives have a broad understanding of complex manufacturing environments and processes. Chances are they've met many similar challenges before with proven solutions.

Training

TRAINING SEMINARS

PIP's 3SP™ team consists of Product Specialists, Product Managers and PIP Sales Partners, who most often are providers of finished and raw material products. Qualified and ready to train at your facility, or at our headquarters in Latham, NY or our facility in Olive Branch, MS where you can experience our customer training center, complete with hands-on activities.

Tools

TOOLS TO MAKE THE JOB SAFER

Today's work environment is dynamic. An aging workforce, transient and diverse workers, as well as an increased reliance on automation create challenges related to communication, distraction, stress and fatigue - all operating at a higher intensity. Training and orientation is short and we rely on quick and comprehensive tools for answers.

PIP® BRAND TRADEMARKS AND REGISTRATIONS STATEMENT

TRADEMARKS

3GX, Abrasion Gard™, ACP™, Adversary™, Air Force™, Ambi-dex™, Ambi-Thix™, Anser™, Anti-ReflectivePLUS™, Aqua Armor™, ArmorFlex™, ArmorGrip™, ArmorLite™, ArmorLiteXT™, ArmorTuff™, ArmorTuff XT™, Arctic Blast™, Arctic Tek™, Arctick Xtreme™, Assurance™, Assurance Plus™, Atlas™, AutoX™, Barbarian™, Black Pearl™, Blade Defender™, Blue Bison™, Blu Food™, BioTek™, Bond™, Boss™, Bouton™ Optical, Bringing the Best of the World to You™, Brahma Quality™, Bullseye™, Cabaret™, ChemFR™, ChemGuard+™, ChemGrip™, CleanTeam™, Cord™, Commander™, Cut Risk Hazard Matrix™, Dom™, Double V™, Dynamic™, Dynee Mytee™, Dynee Mytee Plus™, Dynee White™, Duo-Pro™, E-Flare™, ESP™, Eva™, Excalibur™, Extreme™, Extreme Work™, EZ-COOL™, EZ-Twist™, Falcon™, FingerNails™, FlashFire™, Flexi Grip™, Flexi Pro™, Flox™, Fogless 3Sixty™, Fortify™, Fuselage™, GP™, Gray Ghost™, Great White™, Grippaz™, Green Ape™, G-Tek™, Guardian™, Hi-Voltage AC™, Hi-Voltage ARC™, Hot Hands™, Hot Wing™, Ironcat™, Irontex™, KEV™, K-Force™, Kilimanjaro™, Knife Hawwk™, Lady Eva™, Mag Readers™, Maximum Safety™, Mega Bullet™, Mega Flare™, Mega T-Fit™, Mighty Blue™, MirrorPLUS™, Mission™, Munk™, Nano Bullet™, Neofoam™, PermFlex™, PIP™, PolarizedXL5™, PolyKor™, PolyKor X7™, PolyTuff™, PosiGrip™, PosiShield™, Posi-Therm™, PosiWear™, Posi-Wear BA™, Posi-Wear FR™, Posi-Wear M3™, Posi-Wear UB™, Power Grip+™, PowerSoft™, Pritex™, ProCoat™, Pro Series™, Oil Armor™, QRP™, Qualagrip™, Qualaknit™, Qualakote™, QualaSheer™, Qualatex™, Qualatherm™, Qualatrilite™, R2™, Recon™, Red Viper™, Rigger™, Rocky™, Ruff Grip™, SafetyGear by PIP™, Safety Works™, ScrapKing™, Smart Fit™, SoftStar™, Stone™, Supreme™, Supersonic™, Tech™, The Assembler™, The Boss™, The Scout™, Tom Cat™, Uniform Technology™, U-Fit™, West Chester™, Whistler™, Xrystal™, XtraTuff™, Xtricate™, Zenon Z11sm™, Zenon Z12™, Zenon Z12R™, Zenon Z13™, Zenon Z13R™, Zenon Z14sn™, Zenon Z28™, Zenon Z36™, Zenon Z44™, Z-Lyte™ are registered trademarks or trademarks pending registration of Protective Industrial Products, Inc. The PIP® logo is also registered to Protective Industrial Products, Inc.

Active™, AD-APT™, AIRtech™, Comfort™, Elite™, Endurance™, MaxiChem™, MaxiCut™, MaxiCut™ Oil™, MaxiCut™ Ultimate DT™, MaxiDry™, MaxiDry™ Plus™, MaxiDry™ Zero™, MaxiFlex™ Ultimate™ and MaxiFoam™ are registered trademarks or trademarks pending registration of ATG.

EverGrip™, Kut Gard™ and Temp-Gard™ are registered trademarks or trademarks pending registration of PI Industries.

Dare Bigger™, DuPont™, Kevlar™, Lycra™, Nomex™ and Protera™ are trademarks or registered trademarks of E.I. du Pont de Nemours and Company.

Velcro™ is a registered trademark of Velcro Industries B.V.

3M™ and Thinsulate™ are trademarks of 3M™.

Dyneema™ is a registered trademark of DSM.

HyperKewl™ is a trademark of TechNiche International.

REALTREE™ is a registered trademark of Jordan Outdoor Enterprises, Ltd.

UltraSoft™ is a registered trademark of Westex™.

Actifresh™ is a registered trademark of British Sanitized Limited.

Aerolite™, Bushmaster™, Classic™ Extreme, Comfort Plus™, EasyJust™, EVO™, EVO™ Ascend™, EVO™ VISTA Lens™, EVO™ VISTAshield™, EVOLite™ Skyworker™, Evolution™, EVOSpec™, Hard Cap A1+™, Inter EXV™, Inter GPV™, J Muff™, MK8 Evolution™, PowerCap™, Surefit™ and Top Cap™, are registered trademarks or trademarks pending registration of JSP™.

Secure™ is a trademark of Hellberg Safety AB.

Novax™ is a registered trademark of GB Industries.

ActivGrip™ Advance™, ActivGrip™, MicroFinish™, N-Spector XRT and PowerGrab™ are registered trademarks or trademarks pending registration of the TOWA Corporation.

ATA™, US Mesh™ and Claw Cover™ are registered trademarks or trademarks pending registration of Worldwide Protective Products.

LIMITED WARRANTY

Protective Industrial Products, Inc. (PIP) warrants only that PIP products will be free from defects in materials and workmanship at the time of sale. Upon receipt of each shipment, the customer must examine the products for defect or shortage and notify PIP in writing within thirty (30) days after such receipt of any claims reasonably discernible within such thirty (30) day period. All claims not reasonably discernible within thirty (30) days must be made in writing within one (1) year after receipt of shipment. Any claim not timely made shall be waived. This limited warranty is exclusive and in lieu of all other warranties, express, implied or statutory. PIP's entire obligation and the exclusive remedy to any party for breach of this limited warranty shall be limited to replacement of the defective product or refund of the original purchase price of the product, at PIP's option. PIP's limited warranty shall not apply to PIP products that have been subject to misuse, accident, negligence, handling, storage, or use.

DISCLAIMER OF IMPLIED WARRANTIES

All implied warranties which may arise by implication of law or application, course of dealing, usage of trade, including, but not limited to, implied warranties of merchantability, fitness for a particular purpose title, and non-infringement are expressly excluded. The user is solely responsible for the suitability of the product selected for a particular application. This catalog is the exclusive property of Protective Industrial Products, Inc. It may not be copied, duplicated or reproduced in whole or in part by any means without the written permission of Protective Industrial Products, Inc.

TRIAL-ORDER PROGRAM

Trial orders are available to customers of Protective Industrial Products distributors on a satisfaction or no-pay basis. The program lets end-users evaluate PIP gloves, in their actual application and on-site condition, on a satisfaction-or-they-don't-pay basis to make sure they're the right gloves for the job. For more information about our "Satisfaction-or-No-Pay" guaranteed Trial Order Program, please contact your PIP Sales Representative.



PROTECTIVE INDUSTRIAL PRODUCTS

Leaders in Hand Protection and PPE







PROTECTIVE INDUSTRIAL PRODUCTS, INC.

968 Albany Shaker Road | Latham, NY 12110

Customer Service Direct: 855-284-6800

Main Phone: 518-861-0133

sales@pipusa.com | www.pipusa.com

10/2021 Rev.4
PRINTED IN CANADA

